

ASSEMBLY
27th session
Agenda item 9

A 27/Res.1049
20 December 2011
Original: ENGLISH

Resolution A.1049(27)

**Adopted on 30 November 2011
(Agenda item 9)**

**INTERNATIONAL CODE ON THE ENHANCED PROGRAMME OF
INSPECTIONS DURING SURVEYS OF BULK CARRIERS
AND OIL TANKERS, 2011 (2011 ESP CODE)**

THE ASSEMBLY,

RECALLING Article 15(j) of the Convention on the International Maritime Organization regarding the functions of the Assembly in relation to regulations and guidelines concerning maritime safety and the prevention and control of marine pollution from ships,

RECALLING ALSO resolution A.744(18) by which the Assembly adopted the *Guidelines on the enhanced programme of inspections during surveys of bulk carriers and oil tankers* (hereinafter referred to as "the Guidelines"),

NOTING that the 1994 Conference of Contracting Governments to the International Convention for the Safety of Life at Sea (SOLAS), 1974 (hereinafter referred to as "the Convention") adopted regulation XI-1/2 of the Convention to make the provisions of the Guidelines mandatory,

NOTING ALSO resolutions MSC.49(66), MSC.105(73), MSC.125(75), MSC.144(77), MSC.197(80), MSC.261(84) and resolution 2 of the 1997 Conference of Contracting Governments to the Convention, by which amendments to the Guidelines were adopted by the Maritime Safety Committee and the Conference of Contracting Governments to the Convention, in accordance with article VIII(b) and regulation XI-1/2 of the Convention, as appropriate,

RECOGNIZING that the numerous amendments made to the Guidelines necessitated a comprehensive revision in order to ensure the effective implementation of their provisions and to maintain the highest practical level of safety,

HAVING CONSIDERED the recommendation made by the Maritime Safety Committee at its eighty-ninth session,

1. ADOPTS the International Code on the Enhanced Programme of Inspections during Surveys of Bulk Carriers and Oil Tankers, 2011 (2011 ESP Code), as set out in the annex to the present resolution;

2. INVITES Contracting Governments to the Convention to note that the 2011 ESP Code will become effective upon entry into force of the associated amendments to chapter XI-1 of the Convention;

3. REQUESTS the Secretary-General of the Organization to transmit certified copies of the present resolution and the 2011 ESP Code, contained in the annex, to all Contracting Governments to the Convention after the aforementioned amendments to chapter XI-1 of the Convention have been adopted;

4. ALSO REQUESTS the Secretary-General of the Organization to transmit copies of the present resolution and the 2011 ESP Code contained in the annex to all Members of the Organization which are not Contracting Governments to the SOLAS Convention after the aforementioned amendments to chapter XI-1 of the Convention have been adopted;

5. FURTHER REQUESTS the Maritime Safety Committee to keep the Code under review and update it as necessary, in the light of experience gained in its application.

Annex

**INTERNATIONAL CODE ON THE ENHANCED PROGRAMME OF INSPECTIONS
DURING SURVEYS OF BULK CARRIERS AND OIL TANKERS, 2011
(2011 ESP CODE)****Contents****ANNEX A****CODE ON THE ENHANCED PROGRAMME OF INSPECTIONS DURING SURVEYS OF
BULK CARRIERS****Part A****CODE ON THE ENHANCED PROGRAMME OF INSPECTIONS DURING SURVEYS OF
BULK CARRIERS HAVING SINGLE-SIDE SKIN CONSTRUCTION**

- 1 General**
 - 1.1 Application
 - 1.2 Definitions
 - 1.3 Repairs
 - 1.4 Surveyors
 - 1.5 Thickness measurements and close-up surveys

- 2 Renewal survey**
 - 2.1 General
 - 2.2 Dry-dock survey
 - 2.3 Space protection
 - 2.4 Hatch covers and coamings
 - 2.5 Extent of overall and close-up surveys
 - 2.6 Extent of thickness measurements
 - 2.7 Extent of tank pressure testing
 - 2.8 Additional renewal survey requirements after determining compliance with regulations XII/12 and XII/13 of the Convention

- 3 Annual survey**
 - 3.1 General
 - 3.2 Examination of the hull
 - 3.3 Examination of weather decks, hatch covers and coamings
 - 3.4 Examination of cargo holds
 - 3.5 Examination of ballast tanks
 - 3.6 Additional annual survey requirements for the foremost cargo hold of ships subject to regulation XII/9.1 of the Convention in accordance with the requirements of annex 12
 - 3.7 Additional annual survey requirements after determining compliance with regulations XII/12 and XII/13 of the Convention

- 4 Intermediate survey**
 - 4.1 General
 - 4.2 Bulk carriers 5 to 10 years of age
 - 4.3 Bulk carriers 10 to 15 years of age
 - 4.4 Bulk carriers exceeding 15 years of age

5 Preparations for survey

- 5.1 Survey programme
- 5.2 Conditions for survey
- 5.3 Access to structures
- 5.4 Equipment for survey
- 5.5 Surveys at sea or at anchorage
- 5.6 Survey planning meeting

6 Documentation on board

- 6.1 General
- 6.2 Survey report file
- 6.3 Supporting documents
- 6.4 Review of documentation on board

7 Procedures for thickness measurements

- 7.1 General
- 7.2 Certification of thickness measurement company
- 7.3 Reporting

8 Reporting and evaluation of survey

- 8.1 Evaluation of survey report
- 8.2 Reporting

Annexes

- Annex 1 Requirements for close-up survey at renewal surveys
- Annex 2 Requirements for thickness measurements at renewal surveys
- Annex 3 Owner's inspection report
- Annex 4A Survey programme
- Annex 4B Survey planning questionnaire
- Annex 5 Procedures for certification of a company engaged in thickness measurement of hull structures
- Annex 6 Survey reporting principles
- Annex 7 Condition Evaluation Report
- Annex 8 Recommended procedures for thickness measurements
- Annex 9 Guidelines for technical assessment in conjunction with the planning of enhanced surveys for bulk carriers – Renewal survey hull
- Annex 10 Requirements for extent of thickness measurement at areas of substantial corrosion
- Annex 11 Guidelines for the gauging of the vertically corrugated transverse watertight bulkhead between holds Nos.1 and 2
- Annex 12 Additional annual survey requirements for the foremost cargo hold of ships subject to regulation XII/9.1 of the Convention
- Annex 13 Strength of cargo hatch cover securing arrangements for bulk carriers
- Annex 14 Procedural requirements for thickness measurements
- Annex 15 Guidelines for the thickness measurements of side shell frames and brackets in single-side skin bulk carriers required to comply with resolution MSC.168(79)

Part B**CODE ON THE ENHANCED PROGRAMME OF INSPECTIONS DURING SURVEYS OF BULK CARRIERS HAVING DOUBLE-SIDE SKIN CONSTRUCTION**

- 1 General**
 - 1.1 Application
 - 1.2 Definitions
 - 1.3 Repairs
 - 1.4 Surveyors
 - 1.5 Thickness measurements and close-up surveys

- 2 Renewal survey**
 - 2.1 General
 - 2.2 Dry-dock survey
 - 2.3 Space protection
 - 2.4 Hatch covers and coamings
 - 2.5 Extent of overall and close-up surveys
 - 2.6 Extent of thickness measurements
 - 2.7 Extent of tank pressure testing
 - 2.8 Additional renewal survey requirements after determining compliance with regulations XII/12 and XII/13 of the Convention

- 3 Annual survey**
 - 3.1 General
 - 3.2 Examination of the hull
 - 3.3 Examination of weather decks, hatch covers and coamings
 - 3.4 Examination of cargo holds
 - 3.5 Examination of ballast tanks
 - 3.6 Additional annual survey requirements after determining compliance with regulations XII/12 and XII/13 of the Convention

- 4 Intermediate survey**
 - 4.1 General
 - 4.2 Double-side skin bulk carriers 5 to 10 years of age
 - 4.3 Double-side skin bulk carriers 10 to 15 years of age
 - 4.4 Double-side skin bulk carriers exceeding 15 years of age

- 5 Preparations for survey**
 - 5.1 Survey programme
 - 5.2 Conditions for survey
 - 5.3 Access to structures
 - 5.4 Equipment for survey
 - 5.5 Surveys at sea or at anchorage
 - 5.6 Survey planning meeting

- 6 Documentation on board**
 - 6.1 General
 - 6.2 Survey report file
 - 6.3 Supporting documents
 - 6.4 Review of documentation on board

7 Procedures for thickness measurements

- 7.1 General
- 7.2 Certification of thickness measurement company
- 7.3 Reporting

8 Reporting and evaluation of survey

- 8.1 Evaluation of survey report
- 8.2 Reporting

Annexes

- Annex 1 Requirements for close-up survey at renewal surveys
- Annex 2 Requirements for thickness measurements at renewal surveys
- Annex 3 Owner's inspection report
- Annex 4A Survey programme
- Annex 4B Survey planning questionnaire
- Annex 5 Procedures for certification of a company engaged in thickness measurement of hull structures
- Annex 6 Survey reporting principles
- Annex 7 Condition Evaluation Report
- Annex 8 Recommended procedures for thickness measurements
- Annex 9 Guidelines for technical assessment in conjunction with planning for enhanced surveys of double-side skin bulk carriers – Renewal survey hull
- Annex 10 Requirements for extent of thickness measurements at those areas of substantial corrosion of bulk carriers with double-side skin construction within the cargo length area
- Annex 11 Strength of cargo hatch cover securing arrangements for bulk carriers
- Annex 12 Procedural requirements for thickness measurements

ANNEX B

CODE ON THE ENHANCED PROGRAMME OF INSPECTIONS DURING SURVEYS OF OIL TANKERS

Part A

CODE ON THE ENHANCED PROGRAMME OF INSPECTIONS DURING SURVEYS OF DOUBLE-HULL OIL TANKERS

1 General

- 1.1 Application
- 1.2 Definitions
- 1.3 Repairs
- 1.4 Surveyors
- 1.5 Thickness measurements and close-up surveys

2 Renewal survey

- 2.1 General
- 2.2 Dry-dock survey
- 2.3 Tank corrosion prevention system
- 2.4 Extent of overall and close-up surveys
- 2.5 Extent of thickness measurements
- 2.6 Extent of tank pressure testing

3 Annual survey

- 3.1 General
- 3.2 Examination of the hull
- 3.3 Examination of weather decks
- 3.4 Examination of cargo pump-rooms and pipe tunnels if fitted
- 3.5 Examination of ballast tanks

4 Intermediate survey

- 4.1 General
- 4.2 Oil tankers 5 to 10 years of age
- 4.3 Oil tankers 10 to 15 years of age
- 4.4 Oil tankers exceeding 15 years of age

5 Preparations for survey

- 5.1 Survey programme
- 5.2 Conditions for survey
- 5.3 Access to structures
- 5.4 Equipment for survey
- 5.5 Surveys at sea or at anchorage
- 5.6 Survey planning meeting

6 Documentation on board

- 6.1 General
- 6.2 Survey report file
- 6.3 Supporting documents
- 6.4 Review of documentation on board

7 Procedures for thickness measurements

- 7.1 General
- 7.2 Certification of thickness measurement company
- 7.3 Reporting

8 Reporting and evaluation of survey

- 8.1 Evaluation of survey report
- 8.2 Reporting

Annexes

- Annex 1 Minimum requirements for close-up survey at renewal survey of double-hull oil tankers
- Annex 2 Minimum requirements for thickness measurements at renewal survey of double-hull oil tankers
- Annex 3 Minimum requirements for tank testing at renewal survey of double-hull oil tankers
- Annex 4 Requirements for extent of thickness measurements at areas of substantial corrosion of double-hull oil tankers

Annex 5	Owner's inspection report
Annex 6A	Survey programme
Annex 6B	Survey planning questionnaire
Annex 7	Procedures for certification of a company engaged in thickness measurement of hull structures
Annex 8	Survey reporting principles
Annex 9	Condition Evaluation Report
Annex 10	Recommended procedures for thickness measurements of double-hull oil tankers
Annex 11	Guidelines for technical assessment in conjunction with the planning of enhanced surveys for oil tankers
Annex 12	Criteria for longitudinal strength of hull girder for oil tankers

Part B

CODE ON THE ENHANCED PROGRAMME OF INSPECTIONS DURING SURVEYS OF OIL TANKERS OTHER THAN DOUBLE-HULL OIL TANKERS

1 General

- 1.1 Application
- 1.2 Definitions
- 1.3 Repairs
- 1.4 Surveyors
- 1.5 Thickness measurements and close-up surveys

2 Renewal survey

- 2.1 General
- 2.2 Dry-dock survey
- 2.3 Tank corrosion prevention system
- 2.4 Extent of overall and close-up surveys
- 2.5 Extent of thickness measurements
- 2.6 Extent of tank pressure testing

3 Annual survey

- 3.1 General
- 3.2 Examination of the hull
- 3.3 Examination of weather decks
- 3.4 Examination of cargo pump-rooms and pipe tunnels if fitted
- 3.5 Examination of ballast tanks

4 Intermediate survey

- 4.1 General
- 4.2 Oil tankers 5 to 10 years of age
- 4.3 Oil tankers 10 to 15 years of age
- 4.4 Oil tankers exceeding 15 years of age

5 Preparations for survey

- 5.1 Survey programme
- 5.2 Conditions for survey
- 5.3 Access to structures
- 5.4 Equipment for survey
- 5.5 Surveys at sea or at anchorage
- 5.6 Survey planning meeting

6 Documentation on board

- 6.1 General
- 6.2 Survey report file
- 6.3 Supporting documents
- 6.4 Review of documentation on board

7 Procedures for thickness measurements

- 7.1 General
- 7.2 Certification of thickness measurement company
- 7.3 Reporting

8 Reporting and evaluation of survey

- 8.1 Evaluation of survey report
- 8.2 Reporting

Annexes

- Annex 1 Requirements for close-up survey at renewal surveys
- Annex 2 Requirements for thickness measurements at renewal surveys
- Annex 3 Requirements for tank pressure testing at renewal surveys
- Annex 4 Requirements for extent of thickness measurements at areas of substantial corrosion
- Annex 5 Owner's inspection report
- Annex 6A Survey programme
- Annex 6B Survey planning questionnaire
- Annex 7 Procedures for certification of a company engaged in thickness measurement of hull structures
- Annex 8 Survey reporting principles
- Annex 9 Condition Evaluation Report
- Annex 10 Recommended procedures for thickness measurements
- Annex 11 Guidelines for technical assessment in conjunction with the planning of enhanced surveys for oil tankers
- Annex 12 Criteria for longitudinal strength of hull girder for oil tankers

ANNEX A

CODE ON THE ENHANCED PROGRAMME OF INSPECTIONS DURING THE SURVEYS OF BULK CARRIERS

Part A

CODE ON THE ENHANCED PROGRAMME OF INSPECTIONS DURING SURVEYS OF BULK CARRIERS HAVING SINGLE-SIDE SKIN CONSTRUCTION

1 General

1.1 *Application*¹

1.1.1 The Code should apply to all self-propelled bulk carriers of 500 gross tonnage and above other than double-side skin bulk carriers as defined in paragraph 1.2.1 of part B of annex A.

1.1.2 The Code should apply to surveys of hull structure and piping systems in way of cargo holds, cofferdams, pipe tunnels, void spaces, fuel oil tanks, within the cargo length area and all ballast tanks.

1.1.3 The Code contains the minimum extent of examination, thickness measurements and tank testing. The survey should be extended when substantial corrosion and/or structural defects are found and include additional close-up survey when necessary.

1.1.4 Ships subject to compliance with regulation XII/6.1 of the Convention should be subject to the additional thickness measurement guidance contained in annex 11.

1.1.5 Ships subject to compliance with resolution MSC.168(79) should be subject to the additional thickness measurement guidance contained in annex 15.

1.1.6 For bulk carriers with hybrid cargo hold arrangements, e.g. with some cargo holds of single-side skin and others of double-side skin, the requirements of part B of annex A apply to cargo holds of double-side skin and associated wing spaces.

1.1.7 The surveys should be carried out during the surveys prescribed by regulation I/10 of the 1974 SOLAS Convention, as amended.

1.2 *Definitions*

1.2.1 *Bulk carrier* is a ship which is constructed generally with single deck, topside tanks and hopper side tanks in cargo spaces, and is intended primarily to carry dry cargo in bulk and includes combination carriers.²

¹ The intention of the Code is to ensure that an appropriate level of review of plans and documents is conducted and consistency in application is attained. Such evaluation of survey reports, survey programmes, planning documents, etc., should be carried out at the managerial level of the Administration or organization recognized by the Administration.

² For single-side skin combination carriers additional requirements are specified in the Guidelines on the enhanced programme of inspections during surveys for oil tankers set out in part B of annex B.

1.2.2 *Ballast tank* is a tank which is used for salt water ballast, or, where applicable, a space which is used for both cargo and salt water ballast will be treated as a ballast tank when substantial corrosion has been found in that space.

1.2.3 *Spaces* are separate compartments including holds, tanks, cofferdams and void spaces bounding cargo holds, decks and the outer hull.

1.2.4 *Overall survey* is a survey intended to report on the overall condition of the hull structure and determine the extent of additional close-up surveys.

1.2.5 *Close-up survey* is a survey where the details of structural components are within the close visual inspection range of the surveyor, i.e. normally within reach of hand.

1.2.6 *Transverse section* is the cross section of the hull perpendicular to the ship's centerline and includes all longitudinal members such as plating, longitudinals and girders at the deck, side and bottom, inner bottom and hopper side plating, longitudinal bulkheads, and bottom plating in top wing tanks.

1.2.7 *Representative spaces* are those which are expected to reflect the condition of other spaces of similar type and service and with similar corrosion prevention systems. When selecting representative spaces account should be taken of the service and repair history on board and identifiable critical and/or suspect areas.

1.2.8 *Suspect areas* are locations showing substantial corrosion and/or are considered by the surveyor to be prone to rapid wastage.

1.2.9 *Substantial corrosion* is an extent of corrosion such that assessment of corrosion pattern indicates wastage in excess of 75 per cent of allowable margins, but within acceptable limits. For ships built under the IACS Common Structural Rules, substantial corrosion is an extent of corrosion such that the assessment of the corrosion pattern indicates a gauged (or measured) thickness between $t_{net} + 0.5$ mm and t_{net} .

1.2.10 *A corrosion prevention system* is normally considered a full hard protective coating. Hard protective coating should usually be epoxy coating or equivalent. Other coating systems, which are neither soft nor semi-hard coatings, may be considered acceptable as alternatives provided that they are applied and maintained in compliance with the manufacturer's specifications.

1.2.11 *Coating condition* is defined as follows:

GOOD condition with only minor spot rusting;

FAIR condition with local breakdown of coating at edges of stiffeners and weld connections and/or light rusting over 20 per cent or more of areas under consideration, but less than as defined for POOR condition; and

POOR condition with general breakdown of coating over 20 per cent or more of areas or hard scale at per cent or more of areas under consideration.

1.2.12 *Critical structural areas* are locations which have been identified from calculations to require monitoring or from the service history of the subject ship or from similar or sister ships to be sensitive to cracking, buckling or corrosion which would impair the structural integrity of the ship.

1.2.13 *Cargo length area* is that part of the ship which includes cargo holds and adjacent areas including fuel tanks, cofferdams, ballast tanks and void spaces.

1.2.14 *Intermediate survey* is a survey carried out either at the second or third annual survey or between these surveys.

1.2.15 *A prompt and thorough repair* is a permanent repair completed at the time of survey to the satisfaction of the surveyor, therein removing the need for the imposition of any associated condition of classification or recommendation.

1.2.16 *Convention* means the International Convention for the Safety of Life at Sea, 1974, as amended.

1.2.17 *Specially considered* (in connection with close-up surveys and thickness measurements) means sufficient close-up inspection and thickness measurements are taken to confirm the actual average condition of the structure under the coating.

1.3 *Repairs*

1.3.1 Any damage in association with wastage over the allowable limits (including buckling, grooving, detachment or fracture), or extensive areas of wastage over the allowable limits, which affects or, in the opinion of the Administration, will affect the ship's structural, watertight or weathertight integrity, should be promptly and thoroughly (see 1.2.15) repaired. Areas to be considered include:

- .1 side structure and side plating;
- .2 deck structure and deck plating;
- .3 bottom structure and bottom plating;
- .4 inner bottom structure and inner bottom plating;
- .5 inner side structure and inner side plating;
- .6 watertight or oiltight bulkheads;
- .7 hatch covers or hatch coamings; and
- .8 items in 3.3.10.

For locations where adequate repair facilities are not available, the Administration may allow the ship to proceed directly to a repair facility. This may require discharging the cargo and/or temporary repairs for the intended voyage.

1.3.2 Additionally, when a survey results in the identification of corrosion or structural defects, either of which, in the opinion of the Administration, will impair the ship's fitness for continued service, remedial measures should be implemented before the ship continues in service.

1.4 *Surveyors*

For bulk carriers of 20,000 tons deadweight and above, two surveyors should jointly carry out the first scheduled renewal survey after the bulk carrier passes 10 years of age (i.e. third renewal survey), and all subsequent renewal surveys and intermediate surveys.

On bulk carriers of 100,000 tons deadweight and above, the intermediate survey between 10 and 15 years of age should be performed by two surveyors. If the surveys are carried out by a recognized organization, the surveyors should be exclusively employed by such recognized organizations.

1.5 *Thickness measurements and close-up surveys*

In any kind of survey, i.e. renewal, intermediate, annual or other surveys having the scope of the foregoing ones, thickness measurements of structures in areas where close-up surveys are required should be carried out simultaneously with close-up surveys.

2 Renewal survey

2.1 *General*

2.1.1 The renewal survey may be commenced at the fourth annual survey and be progressed during the succeeding year with a view to completion by the fifth anniversary date.

2.1.2 As part of the preparation for the renewal survey, the survey programme should be dealt with in advance of the survey. The thickness measurement should not be held before the fourth annual survey.

2.1.3 The survey should include, in addition to the requirements of the annual survey, examination, tests and checks of sufficient extent to ensure that the hull and related piping, as required in 2.1.5, is in a satisfactory condition and is fit for its intended purpose for the new period of validity of the Cargo Ship Safety Construction Certificate, subject to proper maintenance and operation and to periodical surveys being carried out at the due dates.

2.1.4 All cargo holds, ballast tanks, pipe tunnels, cofferdams and void spaces bounding cargo holds, decks and outer hull should be examined, and this examination should be supplemented by thickness measurement and testing as required by 2.6 and 2.7, to ensure that the structural integrity remains effective. The examination should be sufficient to discover substantial corrosion, significant deformation, fractures, damages or other structural deterioration, that may be present.

2.1.5 All piping systems within the above spaces should be examined and operationally tested under working pressure to the attending surveyor's satisfaction to ensure that the tightness and condition remain satisfactory.

2.1.6 The survey extent of ballast tanks converted to void spaces should be specially considered in relation to the requirements for ballast tanks.

2.1.7 Concurrent crediting to both intermediate survey and renewal survey for surveys and thickness measurements of spaces should not be acceptable.

2.2 *Dry-dock survey*

2.2.1 A survey in dry-dock should be a part of the renewal survey. There should be a minimum of two inspections of the outside of the ship's bottom during the five-year period of the certificate. In all cases, the maximum interval between bottom inspections should not exceed 36 months.

2.2.2 For ships of 15 years of age and over, inspection of the outside of the ship's bottom should be carried out with the ship in dry-dock. For ships of less than 15 years of age, alternate inspections of the ship's bottom not conducted in conjunction with the renewal survey may be carried out with the ship afloat. Inspection of the ship afloat should only be carried out when the conditions are satisfactory and the proper equipment and suitably qualified staff is available.

2.2.3 If a survey in dry-dock is not completed in conjunction with the renewal survey or if the 36 month maximum interval referred to in 2.2.1 is not complied with, the Cargo Ship Safety Construction Certificate should cease to be valid until a survey in dry-dock is completed.

2.2.4 The overall and close-up surveys and thickness measurements, as applicable, of the lower portions of the cargo holds and ballast tanks should be carried out in accordance with the applicable requirements for renewal surveys, if not already performed.

Note: Lower portions of the cargo holds and ballast tanks are considered to be the parts below light ballast water line.

2.3 *Space protection*

2.3.1 Where provided, the condition of the corrosion prevention system of ballast tanks should be examined. For ballast tanks, excluding double-bottom tanks, where a hard protective coating is found in POOR condition as defined in 1.2.11, and it is not renewed, or where a soft or semi-hard coating has been applied, or where a hard protective coating has not been applied from the time of construction, the tanks in question should be examined at annual intervals. Thickness measurements should be carried out as deemed necessary by the surveyor. When such breakdown of hard protective coating is found in water ballast double-bottom tanks and it is not renewed, where a soft or semi-hard coating has been applied or where a hard protective coating has not been applied from the time of construction, the tanks in question may be examined at annual intervals. When considered necessary by the surveyor, or where extensive corrosion exists, thickness measurement should be carried out.

2.3.2 Where a hard protective coating is provided in cargo holds and is found in GOOD condition, the extent of close-up surveys and thickness measurements may be specially considered.

2.4 *Hatch covers and coamings*

The hatch covers and coamings should be surveyed as follows:

2.4.1 A thorough inspection of the items listed in 3.3 should be carried out in addition to all hatch covers and coamings.

2.4.2 Checking of the satisfactory operation of all mechanically operated hatch covers should be made, including:

- .1 stowage and securing in open condition;
- .2 proper fit and efficiency of sealing in closed condition; and
- .3 operational testing of hydraulic and power components, wires, chains, and link drives.

2.4.3 The effectiveness of sealing arrangements of all hatch covers by hose testing or equivalent should be checked.

2.4.4 Thickness measurement of the hatch cover and coaming plating and stiffeners should be carried out as given in annex 2.

2.5 *Extent of overall and close-up surveys*

2.5.1 An overall survey of all tanks and spaces should be carried out at the renewal survey. Fuel oil tanks in the cargo length area should be surveyed as follows:

Renewal survey No.1	Renewal survey No.2	Renewal survey No.3	Renewal survey No.4 and subsequent
Age ≤ 5	5 < Age ≤ 10	10 < Age ≤ 15	15 < Age
None	One	Two	Half, minimum two
<p>Notes:</p> <ol style="list-style-type: none"> 1. These requirements apply to tanks of integral (structural) type. 2. If a selection of tanks is accepted to be examined, then different tanks should be examined at each renewal survey, on a rotational basis. 3. Peak tanks (all uses) should be examined internally at each renewal survey. 4. At renewal survey No.3 and subsequent renewal surveys, one deep tank for fuel oil in the cargo area should be included, if fitted. 			

2.5.2 The minimum requirements for close-up surveys at renewal survey are given in annex 1.

2.5.3 The surveyor may extend the close-up survey as deemed necessary taking into account the maintenance of the spaces under survey, the condition of the corrosion prevention system and where spaces have structural arrangements or details which have suffered defects in similar spaces or on similar ships according to the available information.

2.5.4 For areas in spaces where hard protective coatings are found to be in a GOOD condition, the extent of close-up surveys according to annex 1 may be specially considered. Refer also to 2.3.2.

2.6 *Extent of thickness measurements*

2.6.1 The minimum requirements for thickness measurements at the renewal survey are given in annex 2. Annex 11 provides additional thickness measurement guidelines applicable to the vertically corrugated transverse watertight bulkhead between cargo holds No.1 and No.2 on ships subject to compliance with regulation XII/6.1 of the Convention. For additional thickness measurement guidelines applicable to the side shell frames and brackets on ships subject to compliance with resolution MSC.168(79), reference is made to 1.1.5 and annex 15.

2.6.2 Representative thickness measurements to determine both general and local levels of corrosion in the shell frames and their end attachments in all cargo holds and ballast tanks should be carried out. Thickness measurement should also be carried out to determine the corrosion levels on the transverse bulkhead plating. The extent of thickness measurements

may be specially considered provided the surveyor is satisfied by the close-up examination, that there is no structural diminution, and the hard protective coating where applied remains efficient.

2.6.3 Provisions for extended measurements for areas with substantial corrosion as defined in 1.2.9 are given in annex 10 and may be additionally specified in the survey programme as required in 5.1. These extended thickness measurements should be carried out before the survey is credited as completed. Suspect areas identified at previous surveys should be examined. Areas of substantial corrosion identified at previous surveys should have thickness measurements taken.

2.6.4 The surveyor may further extend the thickness measurements as deemed necessary.

2.6.5 For areas in tanks where hard protective coatings are found to be in GOOD condition as defined in 1.2.11, the extent of thickness measurements according to annex 2 may be specially considered by the Administration.

2.6.6 Transverse sections should be chosen where the largest reductions are suspected to occur or are revealed from deck plating measurements.

2.7 *Extent of tank pressure testing*

2.7.1 All boundaries of water ballast tanks, deep tanks and cargo holds used for water ballast within the cargo length area should be pressure tested. For fuel oil tanks, only representative tanks should be pressure tested.

2.7.2 The surveyor may extend the tank testing as deemed necessary.

2.7.3 Boundaries of ballast tanks should be tested with a head of liquid to the top of air pipes.

2.7.4 Boundaries of ballast holds should be tested with a head of liquid to near the top of hatches.

2.7.5 Boundaries of fuel oil tanks should be tested with a head of liquid to the highest point that liquid will rise under service conditions. Tank testing of fuel oil tanks may be specially considered based on a satisfactory external examination of the tank boundaries and a confirmation from the master stating that the pressure testing has been carried out according to the requirements with satisfactory results.

2.7.6 The testing of double-bottom tanks and other spaces not designed for the carriage of liquid may be omitted, provided a satisfactory internal examination together with an examination of the tanktop is carried out.

2.8 *Additional renewal survey requirements after determining compliance with regulations XII/12 and XII/13 of the Convention*

2.8.1 For ships complying with the requirements of regulation XII/12 of the Convention for hold, ballast and dry space water level detectors, the renewal survey should include an examination and a test of the water ingress detection system and of their alarms.

2.8.2 For ships complying with the requirements of regulation XII/13 of the Convention for the availability of pumping systems, the renewal survey should include an examination and a test of the means for draining and pumping ballast tanks forward of the collision bulkhead and bilges of dry spaces any part of which extends forward of the foremost cargo hold, and of their controls.

3 Annual survey

3.1 General

The annual survey should consist of an examination for the purpose of ensuring, as far as practicable, that the hull, weather decks, hatch covers, coamings and piping are maintained in a satisfactory condition and should take into account the service history, condition and extent of the corrosion prevention system of ballast tanks and areas identified in the survey report file.

3.2 Examination of the hull

3.2.1 Examination of the hull plating and its closing appliances should be carried out as far as can be seen.

3.2.2 Examination of watertight penetrations should be carried out as far as practicable.

3.3 Examination of weather decks, hatch covers and coamings

3.3.1 It should be confirmed that no unapproved changes have been made to the hatch covers, hatch coamings and their securing and sealing devices since the last survey.

3.3.2 A thorough survey of cargo hatch covers and coamings is only possible by examination in the open as well as closed positions and should include verification of proper opening and closing operation. As a result, at least the hatch covers sets within the forward 25 per cent of the ship's length and at least one additional set, such that all the sets on the ship are assessed at least once in every five-year period, should be surveyed open, closed and in operation to the full extent in each direction at each annual survey, including:

- .1 stowage and securing in open condition;
- .2 proper fit and efficiency of sealing in closed condition; and
- .3 operational testing of hydraulic and power components, wires, chains and link drives.

The closing of the covers should include the fastening of all peripheral, and cross joint cleats or other securing devices. Particular attention should be paid to the condition of hatch covers in the forward 25 per cent of the ship's length, where sea loads are normally greatest.

3.3.3 If there are indications of difficulty in operating and securing hatch covers, additional sets above those required by 3.3.2, at the discretion of the surveyor, should be tested in operation.

3.3.4 Where the cargo hatch securing system does not function properly, repairs should be carried out under the supervision of the Administration. Where hatch covers or coamings undergo substantial repairs, the strength of securing devices should be upgraded to comply with annex 13.

3.3.5 For each cargo hatch cover set, at each annual survey, the following items should be surveyed:

- .1 cover panels, including side plates, and stiffener attachments that may be accessible in the open position by close-up survey (for corrosion, cracks, deformation);
- .2 sealing arrangements of perimeter and cross joints (gaskets for condition and permanent deformation, flexible seals on combination carriers, gasket lips, compression bars, drainage channels and non return valves);
- .3 clamping devices, retaining bars, cleating (for wastage, adjustment, and condition of rubber components);
- .4 closed cover locating devices (for distortion and attachment);
- .5 chain or rope pulleys;
- .6 guides;
- .7 guiderails and track wheels;
- .8 stoppers;
- .9 wires, chains, tensioners and gypsies;
- .10 hydraulic system, electrical safety devices and interlocks; and
- .11 end and interpanel hinges, pins and stools where fitted.

3.3.6 At each hatchway, at each annual survey, the coamings, with plating, stiffeners and brackets should be checked for corrosion, cracks and deformation, especially of the coaming tops including close-up survey.

3.3.7 Where considered necessary, the effectiveness of sealing arrangements may be proved by hose or chalk testing supplemented by dimensional measurements of seal compressing components.

3.3.8 Where portable covers, wooden or steel pontoons are fitted, the satisfactory condition of the following should be confirmed, where applicable:

- .1 wooden covers and portable beams, carriers or sockets for the portable beam, and their securing devices;
- .2 steel pontoons, including close-up survey of hatch cover plating;
- .3 tarpaulins;
- .4 cleats, battens and wedges;
- .5 hatch securing bars and their securing devices;
- .6 loading pads/bars and the side plate edge;

- .7 guideplates and chocks; and
- .8 compression bars, drainage channels and drain pipes (if any).

3.3.9 The flame screens on vents to all bunker tanks should be examined.

3.3.10 Bunker and vent piping systems, including ventilators should be examined.

3.4 *Examination of cargo holds*

3.4.1 For bulk carriers of 10 to 15 years of age, the following should be carried out:

- .1 overall survey of all cargo holds;
- .2 close-up examination of sufficient extent, minimum 25 per cent of frames, to establish the condition of the lower region of the shell frames including approximately lower one-third length of the side frame at the side shell and side frame end attachment and the adjacent shell plating in the forward cargo hold. Where this level of survey reveals the need for remedial measures, the survey should be extended to include a close-up survey of all of the shell frames and adjacent shell plating of that cargo hold as well as a close-up survey of sufficient extent of all remaining cargo holds;
- .3 when considered necessary by the surveyor, or where extensive corrosion exists, thickness measurement should be carried out. If the results of these thickness measurements indicate that substantial corrosion is found, the extent of thickness measurements should be increased in accordance with annex 10. These extended thickness measurements should be carried out before the annual survey is credited as completed. Suspect areas identified at previous surveys should be examined. Areas of substantial corrosion identified at previous surveys should have thickness measurements taken;
- .4 where the hard protective coating in cargo holds is found to be in GOOD condition, the extent of close-up surveys and thickness measurements may be specially considered; and
- .5 all piping and penetrations in cargo holds, including overboard piping, should be examined.

3.4.2 For bulk carriers over 15 years of age, the following should be carried out:

- .1 overall survey of all cargo holds;
- .2 close-up examination of sufficient extent, minimum 25 per cent of frames, to establish the condition of the lower region of the shell frames including approximately lower one-third length of the side frame at the side shell and side frame end attachment and the adjacent shell plating in the forward cargo hold and one other selected cargo hold. Where this level of survey reveals the need for remedial measures, the survey should be extended to include a close-up survey of all of the shell frames and adjacent shell plating of the cargo hold as well as a close-up survey of sufficient extent of all remaining cargo holds;

- .3 when considered necessary by the surveyor, or when extensive corrosion exists, thickness measurement should be carried out. If the results of these thickness measurements indicate that substantial corrosion is found, the extent of thickness measurements should be increased in accordance with annex 10. These extended thickness measurements should be carried out before the annual survey is credited as completed. Suspect areas identified at previous surveys should be examined. Areas of substantial corrosion identified at previous surveys should have thickness measurements taken;
- .4 where hard protective coating is fitted in cargo holds and is found in GOOD condition, the extent of the close-up surveys and thickness measurements may be specially considered; and
- .5 all piping and penetrations in cargo holds, including overboard piping, should be examined.

3.5 *Examination of ballast tanks*

Examination of ballast tanks should be carried out when required as a consequence of the results of the renewal survey and intermediate survey. When considered necessary by the Administration, or when extensive corrosion exists, thickness measurement should be carried out. If the results of these thickness measurements indicate that substantial corrosion is found, the extent of thickness measurements should be increased in accordance with annex 10. These extended thickness measurements should be carried out before the survey is credited as completed. Suspect areas identified at previous surveys should be examined. Areas of substantial corrosion identified at previous surveys should have thickness measurements taken.

3.6 *Additional annual survey requirements for the foremost cargo hold of ships subject to regulation XII/9 of the Convention in accordance with the requirements of annex 12*

3.6.1 Ships subject to regulation XII/9 of the Convention are those meeting all of the following conditions:

- .1 bulk carriers of 150 m in length and upwards of single-side skin construction;
- .2 carrying solid bulk cargoes having a density of 1,780 kg/m³ and above;
- .3 constructed before 1 July 1999; and
- .4 constructed with an insufficient number of transverse watertight bulkheads to enable them to withstand flooding of the foremost cargo hold in all loading conditions and remain afloat in a satisfactory condition of equilibrium as specified in regulation XII/4.4 of the Convention.

3.6.2 In accordance with regulation XII/9 of the Convention, for the foremost cargo hold of such ship the additional survey requirements listed in annex 12 should be applied.

3.7 *Additional annual survey requirements after determining compliance with regulations XII/12 and XII/13 of the Convention*

3.7.1 For ships complying with the requirements of regulation XII/12 of the Convention for hold, ballast and dry cargo space water level detectors, the annual survey should include an examination and a test, at random, of the water ingress detection systems and of their alarms.

3.7.2 For ships complying with the requirements of regulation XII/13 of the Convention for the availability of pumping systems, the annual survey should include an examination and a test, of the means for draining and pumping ballast tanks forward of the collision bulkhead and bilges of dry spaces any part of which extends forward of the foremost cargo hold, and of their controls.

4 Intermediate survey

4.1 General

4.1.1 Items that are additional to the requirements of the annual survey may be surveyed either at the second or third annual survey or between these surveys.

4.1.2 The extent of survey is dependent upon the age of the ship as specified in 4.2, 4.3 and 4.4.

4.1.3 Concurrent crediting to both intermediate survey and renewal survey for surveys and thickness measurements of space should not be acceptable.

4.2 Bulk carriers 5 to 10 years of age

4.2.1 Ballast tanks

4.2.1.1 For tanks used for water ballast, an overall survey of representative tanks selected by the surveyor should be carried out. The selection should include fore and aft peak tanks and a number of other tanks, taking into account the total number and type of ballast tanks. If such overall survey reveals no visible structural defects, the examination may be limited to verification that the corrosion prevention system remains efficient.

4.2.1.2 Where POOR coating condition, corrosion or other defects are found in water ballast tanks or where hard protective coating was not applied from the time of construction, the examination should be extended to other ballast tanks of the same type.

4.2.1.3 In ballast tanks other than double-bottom tanks, where a hard protective coating is found in POOR condition and it is not renewed, or where soft or semi-hard coating has been applied, or where a hard protective coating was not applied from the time of construction, the tanks in question should be examined and thickness measurements carried out as considered necessary at annual intervals. When such breakdown of coating is found in ballast double-bottom tanks, where a soft or semi-hard coating has been applied, or where a hard protective coating has not been applied, the tanks in question may be examined at annual intervals. When considered necessary by the surveyor, or where extensive corrosion exists, thickness measurements should be carried out.

4.2.1.4 In addition to the requirements above, suspect areas identified at previous renewal surveys should be overall and close-up surveyed.

4.2.2 *Cargo holds*

4.2.2.1 An overall survey of all cargo holds, including close-up survey of sufficient extent, minimum 25 per cent of frames, should be carried out to establish the condition of:

- .1 shell frames including their upper and lower end attachments, adjacent shell plating, and transverse bulkheads in the forward cargo hold and one other selected cargo hold; and
- .2 areas found to be suspect areas at previous surveys.

4.2.2.2 Where considered necessary by the surveyor as a result of the overall and close-up survey as described in 4.2.2.1, the survey should be extended to include a close-up survey of all of the shell frames and adjacent shell plating of that cargo hold as well as a close-up survey of sufficient extent of all remaining cargo holds.

4.2.3 *Extent of thickness measurement*

4.2.3.1 Thickness measurement should be carried out to an extent sufficient to determine both general and local corrosion levels at areas subject to close-up survey as described in 4.2.2.1. The minimum requirement for thickness measurements at the intermediate survey are areas found to be suspect areas at previous surveys.

4.2.3.2 The extent of thickness measurement may be specially considered provided the surveyor is satisfied by the close-up survey, that there is no structural diminution and the hard protective coatings are found to be in a GOOD condition.

4.2.3.3 Where substantial corrosion is found, the extent of thickness measurements should be increased in accordance with the requirements of annex 10. These extended thickness measurements should be carried out before the survey is credited as completed. Suspect areas identified at previous surveys should be examined. Areas of substantial corrosion identified at previous surveys should have thickness measurements taken.

4.3 *Bulk carriers 10 to 15 years of age*

4.3.1 The requirements of the intermediate survey should be the same extent as the previous renewal survey as required in 2 and 5.1. However, internal examination of fuel tanks and pressure testing of all tanks are not required unless deemed necessary by the attending surveyor.

4.3.2 In application of 4.3.1, the intermediate survey may be commenced at the second annual survey and be progressed during the succeeding year with a view to completion at the third annual survey in lieu of the application of 2.1.1.

4.3.3 In application of 4.3.1, an underwater survey may be considered in lieu of the requirements of 2.2.

4.4 *Bulk carriers exceeding 15 years of age*

4.4.1 The requirements of the intermediate survey should be to the same extent as the previous renewal survey required in 2 and 5.1. However, internal examination of fuel tanks and pressure testing of all tanks are not required unless deemed necessary by the attending surveyor.

4.4.2 In application of 4.4.1, the intermediate survey may be commenced at the second annual survey and be progressed during the succeeding year with a view to completion at the third annual survey in lieu of the application of 2.1.1.

4.4.3 In application of 4.4.1, a survey in dry-dock should be part of the intermediate survey. The overall and close-up surveys and thickness measurements, as applicable, of the lower portions of the cargo holds and water ballast tanks should be carried out in accordance with the applicable requirements for intermediate surveys, if not already performed.

Note: Lower portions of the cargo holds and ballast tanks are considered to be the parts below light ballast water line.

5 Preparations for survey

5.1 Survey programme

5.1.1 The owner in cooperation with the Administration should work out a specific survey programme prior to the commencement of any part of:

- .1 the renewal survey; and
- .2 the intermediate survey for bulk carriers over 10 years of age.

The survey programme should be in a written format based on the information in annex 4A. The survey should not commence until the survey programme has been agreed.

5.1.1.1 Prior to the development of the survey programme, the survey planning questionnaire should be completed by the owner based on the information set out in annex 4B, and forwarded to the Administration.

5.1.1.2 The survey programme at intermediate survey may consist of the survey programme at the previous renewal survey supplemented by the condition evaluation report of that renewal survey and later relevant survey reports. The survey programme should be worked out taking into account any amendments to the survey requirements after the last renewal survey carried out.

5.1.2 In developing the survey programme, the following documentation should be collected and consulted with a view to selecting tanks, holds, areas and structural elements to be examined:

- .1 survey status and basic ship information;
- .2 documentation on board, as described in 6.2 and 6.3;
- .3 main structural plans (scantlings drawings), including information regarding use of high-tensile steels (HTS);
- .4 relevant previous survey and inspection reports from both the classification society and the owner;
- .5 information regarding the use of ship's holds and tanks, typical cargoes and other relevant data;

- .6 information regarding corrosion prevention level on the new building; and
- .7 information regarding the relevant maintenance level during operation.

5.1.3 The submitted survey programme should account for and comply, as a minimum, with the requirements of 2.7 and annexes 1 and 2 for close-up survey, thickness measurement and tank testing, respectively, and is to include relevant information including at least:

- .1 basic ship information and particulars;
- .2 main structural plans (scantling drawings), including information regarding use of high-tensile steels (HTS);
- .3 plan of holds and tanks;
- .4 list of holds and tanks with information on use, protection and condition of coating;
- .5 conditions for survey (e.g. information regarding hold and tank cleaning, gas-freeing, ventilation, lighting, etc.);
- .6 provisions and methods for access to structures;
- .7 equipment for surveys;
- .8 nomination of holds and tanks and areas for close-up survey (see 2.5);
- .9 nomination of sections for thickness measurement (see 2.6);
- .10 nomination of tanks for testing (see 2.7); and
- .11 damage experience related to ship in question.

5.1.4 The Administration will advise the owner of the maximum acceptable structural corrosion diminution levels applicable to the ship.

5.1.5 Use may also be made of the Guidelines for technical assessment in conjunction with the planning of enhanced surveys for bulk carriers contained in annex 9. These Guidelines are a recommended tool which may be invoked at the discretion of the Administration, when considered necessary and appropriate, in conjunction with the preparation of the required survey programme.

5.2 *Conditions for survey*

5.2.1 The owner should provide the necessary facilities for a safe execution of the survey.

5.2.2 In order to enable the attending surveyors to carry out the survey, provisions for proper and safe access should be agreed between the owner and the Administration.

5.2.3 Details of the means of access should be provided in the survey planning questionnaire.

5.2.4 In cases where the provisions of safety and required access are judged by the attending surveyor(s) not to be adequate, the survey of the spaces involved should not proceed.

5.2.5 Cargo holds, tanks and spaces should be safe for access. Cargo holds, tanks and spaces should be gas free and properly ventilated. Prior to entering a tank, void or enclosed space, it should be verified that the atmosphere in the tank is free from hazardous gas and contains sufficient oxygen.

5.2.6 In preparation for survey and thickness measurements and to allow for a thorough examination, all spaces should be cleaned including removal from surfaces of all loose accumulated corrosion scale. Spaces should be sufficiently clean and free from water, scale, dirt, oil residues, etc., to reveal corrosion, deformation, fractures, damages or other structural deterioration as well as the condition of the coating. However, those areas of structure whose renewal has already been decided by the owner need only be cleaned and descaled to the extent necessary to determine the limits of the areas to be renewed.

5.2.7 Sufficient illumination should be provided to reveal corrosion, deformation, fractures, damages or other structural deterioration as well as the condition of the coating.

5.2.8 Where soft or semi-hard coatings have been applied, safe access should be provided for the surveyor to verify the effectiveness of the coating and to carry out an assessment of the conditions of internal structures which may include spot removal of the coating. When safe access cannot be provided, the soft or semi-hard coating should be removed.

5.2.9 The surveyor(s) should always be accompanied by at least one responsible person, assigned by the owner, experienced in tank and enclosed spaces inspection. In addition a backup team of at least two experienced persons should be stationed at the hatch opening of the tank or space that is being surveyed. The back-up team should continuously observe the work in the tank or space and should keep lifesaving and evacuation equipment ready for use.

5.2.10 A communication system should be arranged between the survey party in the cargo hold, tank or space being examined, the responsible officer on deck and, as the case may be, the navigation bridge. The communication arrangements should be maintained throughout the survey.

5.3 *Access to structures*³

5.3.1 For overall survey, means should be provided to enable the surveyor to examine the structure in a safe and practical way.

5.3.2 For close-up surveys of the hull structure, other than cargo hold shell frames, one or more of the following means for access, acceptable to the surveyor, should be provided:

- .1 permanent staging and passages through structures;
- .2 temporary staging and passages through structures;
- .3 lifts and moveable platforms;
- .4 portable ladders;

³ Refer to Guidelines on the means of access to structures for inspection and maintenance of oil tankers and bulk carriers (MSC/Circ.686).

- .5 boats or rafts; and
- .6 other equivalent means.

5.3.3 For close-up surveys of the cargo hold shell frames of bulk carriers less than 100,000 dwt, one or more of the following means for access, acceptable to the surveyor, should be provided:

- .1 permanent staging and passages through structures;
- .2 temporary staging and passages through structures;
- .3 portable ladder restricted to not more than 5 m in length may be accepted for surveys of lower section of a shell frame including bracket;
- .4 hydraulic arm vehicles such as conventional cherry pickers, lifts and movable platforms;
- .5 boats or rafts provided the structural capacity of the hold is sufficient to withstand static loads at all levels of water; and
- .6 other equivalent means.

5.3.4 For close-up surveys of the cargo hold shell frames of bulk carriers of 100,000 dwt and above, the use of portable ladders should not be accepted and one or more of the following means for access, acceptable to the surveyor, should be provided:

Annual surveys, intermediate survey under 10 years of age and first renewal survey:

- .1 permanent staging and passages through structures;
- .2 temporary staging and passages through structures;
- .3 hydraulic arm vehicles such as conventional cherry pickers, lifts and movable platforms;
- .4 boats or rafts provided the structural capacity of the hold is sufficient to withstand static loads at all levels of water; and
- .5 other equivalent means.

Subsequent intermediate surveys and renewal surveys:

- .1 either permanent or temporary staging and passages through structures for close-up survey of at least the upper part of hold frames;
- .2 hydraulic arm vehicles such as conventional cherry pickers for surveys of lower and middle part of shell frames as alternative to staging;
- .3 lifts and movable platforms;

- .4 boats or rafts provided the structural capacity of the hold is sufficient to withstand static loads at all levels of water; and
- .5 other equivalent means.

5.3.5 Notwithstanding the above requirements, the use of a portable ladder fitted with a mechanical device to secure the upper end of the ladder is acceptable for the "close-up examination of sufficient extent, minimum 25 per cent of frames, to establish the condition of the lower region of the shell frames, including approximately lower one third length of side frame at side shell and side frame and attachment and the adjacent shell plating of the forward cargo hold" at annual survey, required in 3.4.1.2 and the "one other selected cargo hold" required in 3.4.2.2.

5.4 *Equipment for survey*

5.4.1 Thickness measurements should normally be carried out by means of ultrasonic test equipment. The accuracy of the equipment should be proven to the surveyor as required.

5.4.2 One or more of the following fracture detection procedures may be required if deemed necessary by the surveyor:

- .1 radiographic equipment;
- .2 ultrasonic equipment;
- .3 magnetic particle equipment; and/or
- .4 dye penetrant.

5.4.3 Explosimeter, oxygen-meter, breathing apparatus, lifelines, riding belts with rope and hook and whistles together with instructions and guidance on their use should be made available during the survey. A safety checklist should be provided.

5.4.4 Adequate and safe lighting should be provided for the safe and efficient conduct of the survey.

5.4.5 Adequate protective clothing should be made available and used (e.g. safety helmet, gloves, safety shoes, etc.) during the survey.

5.5 *Surveys at sea or at anchorage*

5.5.1 Surveys at sea or at anchorage may be accepted provided the surveyor is given the necessary assistance from the personnel on board. Necessary precautions and procedures for carrying out the survey should be in accordance with 5.1, 5.2, 5.3 and 5.4.

5.5.2 A communication system should be arranged between the survey party in the spaces and the responsible officer on deck. This system should also include the personnel in charge of ballast pump handling if boats or rafts are used.

5.5.3 Surveys of tanks or applicable holds by means of boats or rafts should only be undertaken with the agreement of the surveyor, who should take into account the safety arrangements provided, including weather forecasting and ship response under foreseeable conditions and provided the expected rise of water within the tank does not exceed 0.25 m.

5.5.4 When rafts or boats will be used for close-up survey the following conditions should be observed:

- .1 only rough duty, inflatable rafts or boats, having satisfactory residual buoyancy and stability even if one chamber is ruptured, should be used;
- .2 the boat or raft should be tethered to the access ladder and an additional person should be stationed down the access ladder with a clear view of the boat or raft;
- .3 appropriate lifejackets should be available for all participants;
- .4 the surface of water in the tank or hold should be calm (under all foreseeable conditions the expected rise of water within the tank should not exceed 0.25 m) and the water level stationary. On no account should the level of the water be rising while the boat or raft is in use;
- .5 the tank, hold or space must contain clean ballast water only. Even a thin sheen of oil on the water is not acceptable; and
- .6 at no time should the water level be allowed to be within 1 m of the deepest under deck web face flat so that the survey team is not isolated from a direct escape route to the tank hatch. Filling to levels above the deck transverses should only be contemplated if a deck access manhole is fitted and open in the bay being examined, so that an escape route for the survey party is available at all times. Other effective means of escape to the deck may be considered.

5.5.5 Rafts or boats alone may be allowed for inspection of the under deck areas for tanks or spaces, if the depth of the webs is 1.5 m or less.

5.5.6 If the depth of the webs is more than 1.5 m, rafts or boats alone may be allowed only:

- .1 when the coating of the under-deck structure is in GOOD condition and there is no evidence of wastage; or
- .2 if a permanent means of access is provided in each bay to allow safe entry and exit. This means:
 - .1 access direct from the deck via a vertical ladder and a small platform fitted approximately 2 m below the deck in each bay; or
 - .2 access to deck from a longitudinal permanent platform having ladders to deck in each end of the tank. The platform should, for the full length of the tank, be arranged in level with, or above, the maximum water level needed for rafting of under deck structure. For this purpose, the ullage corresponding to the maximum water level should be assumed not more than 3 m from the deck plate measured at the midspan of deck transverses and the middle length of the tank.

If neither of the above conditions are met, then staging or other equivalent means should be provided for the survey of the under-deck areas.

5.5.7 The use of rafts or boats alone in 5.5.5 and 5.5.6 does not preclude the use of boats or rafts to move about within a tank during a survey.

5.6 *Survey planning meeting*

5.6.1 The establishment of proper preparation and the close cooperation between the attending surveyor(s) and the owner's representatives on board prior to and during the survey are an essential part in the safe and efficient conduct of the survey. During the survey on board safety meetings should be held regularly.

5.6.2 Prior to commencement of any part of the renewal and intermediate survey, a survey planning meeting should be held between the attending surveyor(s), the owner's representative in attendance, the thickness measurement company operator (as applicable) and the master of the ship or an appropriately qualified representative appointed by the master or company for the purpose to ascertain that all the arrangements envisaged in the survey programme are in place, so as to ensure the safe and efficient conduct of the survey work to be carried out (see also 7.1.2).

5.6.3 The following is an indicative list of items that should be addressed in the meeting:

- .1 schedule of the vessel (i.e. the voyage, docking and undocking manoeuvres, periods alongside, cargo and ballast operations, etc.);
- .2 provisions and arrangements for thickness measurements (i.e. access, cleaning/descaling, illumination, ventilation, personal safety);
- .3 extent of the thickness measurements;
- .4 acceptance criteria (refer to the list of minimum thicknesses);
- .5 extent of close-up survey and thickness measurement considering the coating condition and suspect areas/areas of substantial corrosion;
- .6 execution of thickness measurements;
- .7 taking representative readings in general and where uneven corrosion/pitting is found;
- .8 mapping of areas of substantial corrosion; and
- .9 communication between attending surveyor(s), the thickness measurement company operator(s) and owner representative(s) concerning findings.

6 Documentation on board

6.1 *General*

6.1.1 The owner should obtain, supply and maintain on board documentation as specified in 6.2 and 6.3, which should be readily available for the surveyor. The condition evaluation report referred to in 6.2 should include a translation into English.

6.1.2 The documentation should be kept on board for the lifetime of the ship.

6.2 *Survey report file*

6.2.1 A survey report file should be a part of the documentation on board consisting of:

- .1 reports of structural surveys (annex 6);
- .2 condition evaluation report (annex 7); and
- .3 thickness measurement reports (annex 8).

6.2.2 The survey report file should be available also in the owner's and the Administration offices, or in the office of the organization recognized by the Administration.

6.3 *Supporting documents*

The following additional documentation should be available on board:

- .1 survey programme as required under 5.1 until such time as the renewal survey, or intermediate survey, as applicable, has been completed.
- .2 main structural plans of cargo holds and ballast tanks;
- .3 previous repair history;
- .4 cargo and ballast history;
- .5 inspections by ship's personnel with reference to:
 - .1 structural deterioration in general;
 - .2 leakages in bulkheads and piping;
 - .3 condition of coating or corrosion prevention system, if any. Guidance for reporting is shown in annex 3; and
- .6 any other information that would help to identify critical structural areas and/or suspect areas requiring inspection.

6.4 *Review of documentation on board*

Prior to survey, the surveyor should examine the completeness of the documentation on board, and its contents as a basis for the survey.

7 Procedures for thickness measurements

7.1 **General**

7.1.1 The required thickness measurements, if not carried out by the recognized organization acting on behalf of the Administration, should be witnessed by a surveyor of the recognized organization. The surveyor should be on board to the extent necessary to control the process.

7.1.2 The thickness measurement company should be part of the survey planning meeting to be held prior to commencing the survey.

7.1.3 Thickness measurements of structures in areas where close-up surveys are required should be carried out simultaneously with close-up surveys.

7.1.4 In all cases the extent of the thickness measurements should be sufficient as to represent the actual average condition.

7.1.5 Procedural requirements for thickness measurements are set out in annex 14.

7.2 *Certification of thickness measurement company*

The thickness measurements should be carried out by a qualified company certified by an organization recognized by the Administration according to principles stated in annex 5.

7.3 *Reporting*

7.3.1 A thickness measurement report should be prepared and submitted to the Administration. The report should give the location of measurements, the thickness measured as well as corresponding original thickness. Furthermore, the report should give the date when the measurements were carried out, type of measuring equipment, names of personnel and their qualifications and be signed by the operator. The thickness measurement report should follow the principles as specified in the recommended procedures for thickness measurements set out in annex 8.

7.3.2 The surveyor should review the final thickness measurement report and countersign the cover page.

8 **Reporting and evaluation of survey**

8.1 *Evaluation of survey report*

8.1.1 The data and information on the structural condition of the ship collected during the survey should be evaluated for acceptability and continued structural integrity of the ship.

8.1.2 The analysis of data should be carried out and endorsed by the Administration or recognized organization authorized by the Administration and the conclusions of the analysis should form a part of the condition evaluation report.

8.2 *Reporting*

8.2.1 Principles for survey reporting are shown in annex 6.

8.2.2 When a survey is split between different survey stations, a report should be made for each portion of the survey. A list of items examined and/or tested (pressure testing, thickness measurements, etc.) and an indication of whether the item has been credited, should be made available to the next attending surveyor(s), prior to continuing or completing the survey.

8.2.3 A condition evaluation report of the survey and results should be issued to the owner as shown in annex 7 and placed on board the ship for reference at future surveys. The condition evaluation report should be endorsed by the Administration or by the recognized organization on behalf of the Administration.

ANNEX 1

REQUIREMENTS FOR CLOSE-UP SURVEY AT RENEWAL SURVEYS

Age ≤ 5 years Renewal Survey No. 1	5 < Age ≤ 10 years Renewal Survey No. 2	10 < Age ≤ 15 years Renewal Survey No. 3	Age > 15 years Renewal Survey No. 4 and subsequent
<p>(A) 25% of shell frames in the forward cargo hold at representative positions</p> <p>(A) Selected frames in remaining cargo holds</p> <p>(B) One transverse web with associated plating and longitudinals in two representative water ballast tanks of each type (i.e. topside, or hopper side tank)</p> <p>(C) Two selected cargo hold transverse bulkheads, including internal structure of upper and lower stools, where fitted</p> <p>(D) All cargo hold hatch covers and coamings (plating and stiffeners)</p>	<p>(A) All shell frames in the forward cargo hold and 25% of shell frames in each of the remaining cargo holds including upper and lower end attachments and adjacent shell plating</p> <p>(A) For bulk carriers of 100,000 dwt and above, all shell frames in the forward cargo hold and 50% of shell frames in each of the remaining cargo holds, including upper and lower end attachments and adjacent shell plating.</p> <p>(B) One transverse web with associated plating and longitudinals in each water ballast tank</p> <p>(B) Forward and aft transverse bulkhead in one ballast tank, including stiffening system</p> <p>(C) All cargo hold transverse bulkheads, including internal structure of upper and lower stools, where fitted</p> <p>(D) All cargo hold hatch covers and coamings (plating and stiffeners)</p> <p>(E) All deck plating and under deck structure inside line of hatch openings between all cargo hold hatches</p>	<p>(A) All shell frames in the forward and one other selected cargo hold and 50% of frames in each of the remaining cargo holds, including upper and lower end attachments and adjacent shell plating</p> <p>(B) All transverse bulkheads in ballast tanks, including stiffening system</p> <p>(B) All transverse webs with associated plating and longitudinals in each water ballast tank</p> <p>Areas (C), (D), and (E) as for renewal survey No.2</p>	<p>(A) All shell frames in all cargo holds including upper and lower end attachments and adjacent shell plating.</p> <p>Areas (B)–(E) as for column 3</p>

- (A) Cargo hold transverse frame.
- (B) Transverse web or watertight transverse bulkhead in water ballast tanks.
- (C) Cargo hold transverse bulkhead platings, stiffeners and girders.
- (D) Cargo hold hatch covers and coamings.
- (E) Deck plating inside line of hatch openings between cargo hold hatches.

See sketches of appendix 3 to annex 8 for areas corresponding to (A), (B), (C), (D) and (E).

See also sketch in annex 15 for zones of side shell frames for ships subject to compliance with resolution MSC.168(79).

Note: Close-up survey of transverse bulkheads to be carried out at four levels:

- Level (a) Immediately above the inner bottom and immediately above the line of gussets (if fitted) and shedders for ships without lower stool.
- Level (b) Immediately above and below the lower stool shelf plate (for those ships fitted with lower stools), and immediately above the line of the shedder plates.
- Level (c) About mid-height of the bulkhead.
- Level (d) Immediately below the upper deck plating and immediately adjacent to the upper wing tank, and immediately below the upper stool shelf plate for those ships fitted with upper stools, or immediately below the topside tank.

ANNEX 2

REQUIREMENTS FOR THICKNESS MEASUREMENTS AT RENEWAL SURVEYS

Age ≤ 5 years	5 < Age ≤ 10 years	10 < Age ≤ 15 years	Age > 15 years
1	2	3	4
<p>1 Suspect areas</p>	<p>1 Suspect areas</p> <p>2 Within the cargo length area: two transverse sections of deck plating outside line of cargo hatch openings</p> <p>3 Measurements, for general assessment and recording of corrosion pattern, of those structural members subject to close-up survey according to annex 1</p> <p>4 Wind and water strakes in way of transverse sections considered under point 2 above</p> <p>5 Selected wind and water strakes outside the cargo length area</p> <p>6 See 1.1.5 and annex 15 for additional thickness measurement guidelines applicable to the side shell frames and brackets on ships subject to compliance with resolution MSC.168(79)</p>	<p>1 Suspect areas</p> <p>2 Within the cargo length area: .1 each deck plate outside line of cargo hatch openings .2 two transverse sections, one of which should be in the amidship area, outside line of cargo hatch openings</p> <p>3 Measurement, for general assessment and recording of corrosion pattern, of those structural members subject to close-up survey according to annex 1</p> <p>4 All wind and water strakes within the cargo length area</p> <p>5 Selected wind and water strakes outside the cargo length area</p> <p>6 See 1.1.5 and annex 15 for additional thickness measurement guidelines applicable to the side shell frames and brackets on ships subject to compliance with resolution MSC.168(79)</p> <p>7 As required by annex 12 for ships subject to compliance with regulation XII/6.1 of the Convention</p>	<p>1 Suspect areas</p> <p>2 Within the cargo length area: .1 each deck plate outside line of cargo hatch openings .2 three transverse sections, one of which should be in the amidship area, outside line of cargo hatch openings .3 each bottom plate</p> <p>3 Point 3 referred to in column 3</p> <p>4 All wind and water strakes, full length</p> <p>5 See 1.1.5 and annex 15 for additional thickness measurement guidelines applicable to the side shell frames and brackets on ship subject to compliance with resolution MSC.168(79)</p> <p>6 As required by annex 12 for ships subject to compliance with regulation XII/6.1 of the Convention</p>

ANNEX 3

OWNER'S INSPECTION REPORT

Structural condition

Ship's name:							
Owner's inspection report – Structural condition							
For tank/hold No:.....							
Grade of steel: deck: side:							
bottom: longitudinal bulkhead:							
Elements	Cracks	Buckles	Corrosion	Coating	Pitting	Modification/repair	Other
	condition						
Deck:							
Bottom:							
Side:							
Side framing:							
Longitudinal bulkheads:							
Transverse bulkheads:							
Repairs carried out due to:							
Thickness measurements carried out (dates):							
Results in general:							
Overdue surveys:							
Outstanding conditions of class:							
Comments:							
Date of inspection:							
Inspected by:							
Signature:							

ANNEX 4A

SURVEY PROGRAMME**Basic information and particulars**

Name of ship:
IMO number:
Flag State:
Port of registry:
Gross tonnage:
Deadweight (metric tonnes):
Length between perpendiculars (m):
Shipbuilder:
Hull number:
Recognized organization (RO):
RO ship identity:
Date of build of the ship:
Owner:
Thickness measurement company:

1 Preamble1.1 *Scope*

1.1.1 The present survey programme covers the minimum extent of overall surveys, close-up surveys, thickness measurements and pressure testing within the cargo length area, cargo holds, ballast tanks, including fore and aft peak tanks, required by the Code.

1.1.2 The arrangements and safety aspects of the survey should be acceptable to the attending surveyor(s).

1.2 *Documentation*

All documents used in the development of the survey programme should be available on board during the survey as required by section 6.

2 Arrangement of cargo holds, tanks and spaces

This section of the survey programme should provide information (either in the form of plans or text) on the arrangement of cargo holds, tanks and spaces that fall within the scope of the survey.

3 List of cargo holds, tanks and spaces with information on their use, extent of coatings and corrosion prevention system

This section of the survey programme should indicate any changes relating to (and should update) the information on the use of the holds and tanks of the ship, the extent of coatings and the corrosion prevention system provided in the survey planning questionnaire.

4 Conditions for survey

This section of the survey programme should provide information on the conditions for survey, e.g. information regarding cargo hold and tank cleaning, gas freeing, ventilation, lighting, etc.

5 Provisions and method of access to structures

This section of the survey programme should indicate any changes relating to (and should update) the information on the provisions and methods of access to structures provided in the survey planning questionnaire.

6 List of equipment for survey

This section of the survey programme should identify and list the equipment that will be made available for carrying out the survey and the required thickness measurements.

7 Survey requirements

7.1 Overall survey

This section of the survey programme should identify and list the spaces that should undergo an overall survey for this ship in accordance with 2.5.1.

7.2 Close-up survey

This section of the survey programme should identify and list the hull structures that should undergo a close-up survey for this ship in accordance with 2.5.2.

8 Identification of tanks for tank testing

This section of the survey programme should identify and list the cargo holds and tanks that should undergo tank testing for this ship in accordance with 2.7.

9 Identification of areas and sections for thickness measurements

This section of the survey programme should identify and list the areas and sections where thickness measurements should be taken in accordance with 2.6.1.

10 Minimum thickness of hull structures

This section of the survey programme should specify the minimum thickness for hull structures of this ship that are subject to survey, according to (a) or (b):

- (a) Determined from the attached wastage allowance table and the original thickness to the hull structure plans of the ship;
- (b) Given in the following table(s):

Area or location	Original as-built thickness (mm)	Minimum thickness (mm)	Substantial corrosion thickness (mm)
Deck			
Plating			
Longitudinals			
Longitudinal girders			
Cross deck plating			
Cross deck stiffeners			
Bottom			
Plating			
Longitudinals			
Longitudinal girders			
Inner bottom			
Plating			
Longitudinals			
Longitudinal girders			
Floors			
Ship side in way of topside tanks			
Plating			
Longitudinals			
Ship side in way of hopper side tanks			
Plating			
Longitudinals			
Ship side in way of tanks (if applicable)			
Plating			
Longitudinals			
Longitudinal stringers			
Ship side in way of cargo holds			
Plating			
Side frames webs			
Side frames flanges			
Upper brackets webs			
Upper brackets flanges			
Lower brackets webs			
Lower brackets flanges			
Longitudinal bulkhead (if applicable)			
Plating			
Longitudinals (if applicable)			
Longitudinal girders (if applicable)			
Transverse bulkheads			
Plating			
Stiffeners (if applicable)			
Upper stool plating			
Upper stool stiffeners			
Lower stool plating			
Lower stool stiffeners			

Area or location	Original as-built thickness (mm)	Minimum thickness (mm)	Substantial corrosion thickness (mm)
Transverse web frames in topside tanks			
Plating			
Flanges			
Stiffeners			
Transverse web frames in hopper tanks			
Plating			
Flanges			
Stiffeners			
Hatch covers			
Plating			
Stiffeners			
Hatch coamings			
Plating			
Stiffeners			

Note: The wastage allowance tables should be attached to the survey programme.

11 Thickness measurement company

This section of the survey programme should identify changes, if any, relating to the information on the thickness measurement company provided in the survey planning questionnaire.

12 Damage experience related to the ship

This section of the survey programme should, using the tables provided below, provide details of the hull damages for at least the last three years in way of the cargo holds, ballast tanks and void spaces within the cargo length area. These damages are subject to survey.

Hull damages sorted by location for this ship

Cargo hold, tank or space number or area	Possible cause, if known	Description of the damages	Location	Repair	Date of repair

Hull damages for sister or similar ships (if available) in the case of design-related damage

Cargo hold, tank or space number or area	Possible cause, if known	Description of the damages	Location	Repair	Date of repair

13 Areas identified with substantial corrosion from previous surveys

This section of the survey programme should identify and list the areas of substantial corrosion from previous surveys.

14 Critical structural areas and suspect areas

This section of the survey programme should identify and list the critical structural areas and the suspect areas, when such information is available.

15 Other relevant comments and information

This section of the survey programme should provide any other comments and information relevant to the survey.

Appendices

Appendix 1 – List of plans

5.1.3.2 requires that main structural plans of cargo holds and ballast tanks (scantling drawings), including information on regarding use of high tensile steel (HTS) should be available. This appendix of the survey programme should identify and list the main structural plans which form part of the survey programme.

Appendix 2 – Survey planning questionnaire

The survey planning questionnaire (annex 4B), which has been submitted by the owner, should be appended to the survey programme.

Appendix 3 – Other documentation

This part of the survey programme should identify and list any other documentation that forms part of the plan.

Prepared by the owner in cooperation with the Administration for compliance with 5.1.3:

Date:

(name and signature of authorized owner's representative)

Date:

(name and signature of authorized representative of the Administration)

ANNEX 4B

SURVEY PLANNING QUESTIONNAIRE

1 The following information will enable the owner in cooperation with the Administration to develop a survey programme complying with the requirements of the Code. It is essential that the owner provides, when completing the present questionnaire, up-to-date information. The present questionnaire, when completed, should provide all information and material required by the Code.

Particulars

Ship's name:

IMO number:

Flag State:

Port of registry:

Owner:

Recognized organization:

RO Ship identity:

Gross tonnage:

Deadweight (metric tonnes):

Date of build:

Information on access provision for close-up surveys and thickness measurement

2 The owner should indicate, in the table below, the means of access to the structures subject to close-up survey and thickness measurement. A close-up survey is an examination where the details of structural components are within the close visual inspection range of the attending surveyor, i.e. normally within reach of hand.

Hold/Tank No.	Structure	Temporary staging	Rafts	Ladders	Direct access	Other means (please specify)
F.P.	Fore peak					
A.P.	Aft peak					
Cargo holds	Hatch side coamings					
	Topside sloping plate					
	Upper stool plating					
	Cross deck					
	Side shell, frames and brackets					
	Transverse bulkhead					
	Hopper tank plating					
	Lower stool					
Topside tanks	Tank top					
	Under deck structure					
	Side shell and structure					
	Sloping plate and structure					
Hopper tanks	Webs and bulkheads					
	Hopper sloping plate and structure					
	Side shell and structure					
	Bottom structure					
	Webs and bulkheads					
	Double-bottom structure					
	Upper stool internal structure					
Lower stool internal structure						

History of bulk cargoes of a corrosive nature (e.g. high sulphur content)

Owner's inspections

3 Using a format similar to that of the table below (which is given as an example), the owner should provide details of the results of their inspections, for the last 3 years – in accordance with the Code – on all CARGO holds and BALLAST tanks and VOID spaces within the cargo area.

Tank/Hold No.	Corrosion protection (1)	Coating extent (2)	Coating condition (3)	Structural deterioration (4)	Hold and tank history (5)
Cargo holds					
Topside tanks					
Hopper tanks					
Double-side skin tanks					
Double-bottom tanks					
Upper stools					
Lower stools					
Fore peak					
Aft peak					
Miscellaneous other spaces:					

Note:

Indicate tanks which are used for oil/ballast.

- 1) HC = hard coating; SC = soft coating;
SH = semi-hard coating; NP = no protection
- 2) U = upper part; M = middle part;
L = lower part; C = complete
- 3) G = good; F = fair; P = poor;
RC = recoated (during the last three years)
- 4) N = no findings recorded; Y = findings recorded, description of findings should be attached to this questionnaire
- 5) DR = Damage & Repair; L = Leakages;
CV = Conversion (description to be attached to this questionnaire)

Name of owner's representative: Signature: Date:

Reports of port State control inspections

List the reports of port State control inspections containing hull structural related deficiencies and relevant information on rectification of the deficiencies:

Safety management system

List non-conformities related to hull maintenance including the associated corrective actions:

Name and address of the approved thickness measurement company

ANNEX 5

PROCEDURES FOR CERTIFICATION OF A COMPANY ENGAGED IN THICKNESS MEASUREMENT OF HULL STRUCTURES**1 Application**

This guidance applies for certification of a company which intends to engage in the thickness measurement of hull structures of ships.

2 Procedures for certification*Submission of documents*

2.1 The following documents should be submitted to an organization recognized by the Administration for approval:

- .1 outline of the company, e.g. organization and management structure;
- .2 experience of the company on thickness measurement of hull structures of ships;
- .3 technicians' careers, i.e. experience of technicians as thickness measurement operators, technical knowledge and experience of hull structure, etc. Operators should be qualified according to a recognized industrial NDT Standard;
- .4 equipment used for thickness measurement such as ultrasonic testing machines and their maintenance/calibration procedures;
- .5 a guide for thickness measurement operators;
- .6 training programmes for technicians for thickness measurement; and
- .7 measurement record format in accordance with recommended procedures for thickness measurements (see annex 8).

Auditing of the company

2.2 Upon reviewing the documents submitted with satisfactory results, the company should be audited in order to ascertain that the company is duly organized and managed in accordance with the documents submitted, and eventually is capable of conducting thickness measurement of the hull structure of ships.

2.3 Certification is conditional upon an on board demonstration of thickness measurement as well as satisfactory reporting.

3 Certification

3.1 Upon satisfactory results of both the audit of the company referred to in 2.2 and the demonstration tests referred to in 2.3, the Administration or organization recognized by the Administration should issue a certificate of approval as well as a notice to the effect that the thickness measurement operation system of the company has been certified.

3.2 Renewal/endorsement of the certificate should be made at intervals not exceeding three years by verification that original conditions are maintained.

4 Report of any alteration to the certified thickness measurement operation system

In cases where any alteration to the certified thickness measurement operation system of the company is made, such an alteration should be immediately reported to the organization recognized by the Administration. Re-audit should be made where deemed necessary by the organization recognized by the Administration.

5 Withdrawal of the certification

The certification may be withdrawn in the following cases:

- .1 where the measurements were improperly carried out or the results were improperly reported;
- .2 where the surveyor found any deficiencies in the approved thickness measurement operation systems of the company; and
- .3 where the company failed to report any alteration referred to in 4 to the organization recognized by the Administration as required.

ANNEX 6

SURVEY REPORTING PRINCIPLES

As a principle, for bulk carriers subject to the Code, the surveyor should include the following contents in his report for survey of hull structure and piping systems, as relevant for the survey.

1 General

1.1 A survey report should be generated in the following cases:

- .1 in connection with commencement, continuation and/or completion of periodical hull surveys, i.e. annual, intermediate and renewal surveys, as relevant;
- .2 when structural damages/defects have been found;
- .3 when repairs, renewals or modifications have been carried out; and
- .4 when condition of class (recommendation) has been imposed or has been deleted.

1.2 The reporting should provide:

- .1 evidence that prescribed surveys have been carried out in accordance with applicable requirements;
- .2 documentation of surveys carried out with findings, repairs carried out and condition of class (recommendation) imposed or deleted;
- .3 survey records, including actions taken, which should form an auditable documentary trail. Survey reports should be kept in the survey report file required to be on board;
- .4 information for planning of future surveys; and
- .5 information which may be used as input for maintenance of classification rules and instructions.

1.3 When a survey is split between different survey stations, a report should be made for each portion of the survey. A list of items surveyed, relevant findings and an indication of whether the item has been credited, are to be made available to the next attending surveyor, prior to continuing or completing the survey. Thickness measurement and tank testing carried out is also to be listed for the next surveyor.

2 Extent of the survey

2.1 Identification of compartments where an overall survey has been carried out.

2.2 Identification of locations, in each ballast tank and cargo hold including hatch covers and coamings, where a close-up survey has been carried out, together with information on the means of access used.

2.3 Identification of locations, in each ballast tank and cargo hold including hatch covers and coamings, where thickness measurement has been carried out.

Note: As a minimum, the identification of location of close-up survey and thickness measurement should include a confirmation, with description of individual structural members, corresponding to the extent of requirements stipulated in annex A based on type of periodical survey and the ship's age.

Where only partial survey is required, i.e. 25 per cent of shell frames, one transverse web, two selected cargo hold transverse bulkheads, the identification should include location within each ballast tank and cargo hold by reference to frame numbers.

2.4 For areas in ballast tanks and cargo holds where protective coating is found to be in good condition and the extent of close-up survey and/or thickness measurement has been specially considered, structures subject to special consideration should be identified.

2.5 Identification of tanks subject to tank testing.

2.6 Identification of piping systems on deck and within cargo holds, ballast tanks, pipe tunnels, cofferdams and void spaces where:

- .1 examination including internal examination of piping with valves and fittings and thickness measurement, as relevant, has been carried out; and
- .2 operational test to working pressure has been carried out.

3 Result of the survey

3.1 Type, extent and condition of protective coating in each tank, as relevant (rated GOOD, FAIR or POOR) including identification of tanks fitted with anodes.

3.2 Structural condition of each compartment with information on the following, as relevant:

- .1 identification of findings, such as:
 - .1 corrosion with description of location, type and extent;
 - .2 areas with substantial corrosion;
 - .3 cracks/fractures with description of location and extent;
 - .4 buckling with description of location and extent; and
 - .5 indents with description of location and extent;
- .2 identification of compartments where no structural damages/defects are found. The report may be supplemented by sketches/photos; and
- .3 thickness measurement report should be verified and signed by the surveyor controlling the measurements on board.

4 Actions taken with respect to findings

4.1 Whenever the attending surveyor is of the opinion that repairs are required, each item to be repaired should be identified in a numbered list. Whenever repairs are carried out, details of the repairs effected should be reported by making specific reference to relevant items in the numbered list.

4.2 Repairs carried out should be reported with identification of:

- .1 compartment;
- .2 structural member;
- .3 repair method (i.e. renewal or modification), including:
 - .1 steel grades and scantlings (if different from the original); and
 - .2 sketches/photos, as appropriate;
- .4 repair extent; and
- .5 non-destructive test (NDT)/tests.

4.3 For repairs not completed at the time of survey, condition of class/recommendation should be imposed with a specific time limit for the repairs. In order to provide correct and proper information to the surveyor attending for survey of the repairs, condition of class/recommendation should be sufficiently detailed with identification of each item to be repaired. For identification of extensive repairs, reference may be made to the survey report.

ANNEX 7

CONDITION EVALUATION REPORT

Issued upon completion of renewal survey

General particulars

Ship's name:	Class/Administration identity number:
	Previous class/Administration identity number(s):
	IMO number:
Port of registry:	National flag:
	Previous national flag(s):
Deadweight (metric tonnes):	Gross tonnage:
	National:
	ITC (1969):
Date of build:	Classification notation:
Date of major conversion:	
Type of conversion:	Owner:
	Previous owner(s):

1 The survey reports and documents listed below have been reviewed by the undersigned and found to be satisfactory.

2 A summary of the survey is attached herewith on sheet 2.

3 The renewal survey has been completed in accordance with the present Code on (date)

Condition evaluation report completed by	Name Signature	Title
Office	Date	
Condition evaluation report verified by	Name Signature	Title
Office	Date	

Attached reports and documents:

- 1)
- 2)
- 3)
- 4)
- 5)

Contents of condition evaluation report

Part 1	– General particulars:	- See front page
Part 2	– Report review:	- Where and how survey was done
Part 3	– Close-up survey:	- Extent (which tanks/holds)
Part 4	– Thickness measurements:	- Reference to thickness measurement report - Summary of where measured - Separate form indicating the spaces with substantial corrosion, and corresponding: - thickness diminution - corrosion pattern
Part 5	– Tank/hold corrosion prevention system:	- Separate form indicating: - location of coating - condition of coating (if applicable)
Part 6	– Repairs:	- Identification of spaces/areas
Part 7	– Condition of class/flag State requirements:	
Part 8	– Memoranda:	- Acceptable defects - Any points of attention for future surveys, e.g. for suspect areas - Extended annual/intermediate survey due to coating breakdown
Part 9	– Conclusion:	- Statement on evaluation/verification of survey report

Extract of thickness measurements

Reference is made to the thickness measurement report:

Position of substantially corroded tanks/areas¹ or areas with deep pitting³	Thickness diminution [%]	Corrosion pattern²	Remarks: (e.g. reference to attached sketches)

Notes:

- 1 Substantial corrosion, i.e. 75 to 100 per cent of acceptable margins wasted.
- 2 P = Pitting
C = Corrosion in general
- 3 Any bottom plating with a pitting intensity of 20 per cent or more, with wastage in the substantial corrosion range or having an average depth of pitting of $\frac{1}{3}$ or more of actual plate thickness should be noted.

Tank/hold corrosion prevention system

Tank/hold Nos. ¹	Tank/hold protection ²	Coating condition ³	Remarks

Notes:

- 1 All ballast tanks and cargo holds should be listed.
- 2 C = Coating
NP = No protection
- 3 Coating condition according to the following standard:
 - GOOD condition with only minor spot rusting.
 - FAIR condition with local breakdown of coating at edges of stiffeners and weld connections and/or light rusting over 20 per cent or more of areas under consideration, but less than as defined for POOR condition.
 - POOR condition with general breakdown of coating over 20 per cent or more of areas or hard scale at 10 per cent or more of areas under consideration.

If coating condition POOR is given, extended annual surveys should be introduced. This should be noted in part 8 of the Contents of condition evaluation report.

ANNEX 8

RECOMMENDED PROCEDURES FOR THICKNESS MEASUREMENTS**General**

1 These procedures should be used for recording thickness measurements as required by part A of annex A.

2 Reporting forms TM1-BC, TM2-BC(i), TM2-BC(ii) TM3-BC, TM4-BC, TM5-BC, TM6-BC, TM7-BC(i) and TM7-BC(ii), set out in appendix 2 should be used for recording thickness measurements and the maximum allowance diminution should be stated. The maximum allowable diminution could be stated in an attached document.

3 Appendix 3 contains guidance diagrams and notes relating to the reporting forms and the requirements for thickness measurement.

4 The reporting forms should, where appropriate, be supplemented by data presented on structural sketches.

Appendix 1	General particulars
Appendix 2	Reports on thickness measurement
Appendix 3	Guidance on thickness measurement

Appendix 1

GENERAL PARTICULARS

Ship's name:
IMO number:
Class/Administration identity number:
Port of registry:
Gross tonnage:
Deadweight:
Date of build:
Classification society:

Name of company performing thickness measurement:
.....
Thickness measurement company certified by:
Certificate number:
Certificate valid from: to
Place of measurement:
First date of measurement:
Last date of measurement:
Renewal survey/intermediate survey⁴ due:
Details of measurement equipment:
Qualification of operator:

Report number: consisting of pages
Name of operator: Name of surveyor:
Signature of operator: Signature of surveyor:
Company official stamp: Administration:

Official stamp

⁴ Delete as appropriate.

Appendix 2

REPORTS ON THICKNESS MEASUREMENT

Reports on thickness measurement of all deck plating, all bottom shell plating or side shell plating (TM1-BC)

Ship's name..... IMO number..... Class Identity No.....Report No.....

STRAKE POSITION																	
PLATE POSITION	No. or letter	Orig. thk. (mm)	Forward reading						Aft reading						Mean diminution		Maximum allowable diminution (mm)
			Gauged		Diminution P		Diminution S		Gauged		Diminution P		Diminution S		P	S	
			P	S	mm	%	mm	%	P	S	mm	%	mm	%			
12th forward																	
11th																	
10th																	
9th																	
8th																	
7th																	
6th																	
5th																	
4th																	
3rd																	
2nd																	
1st																	
Amidships																	
1st aft																	
2nd																	
3rd																	
4th																	
5th																	
6th																	
7th																	
8th																	
9th																	
10th																	
11th																	
12th																	

Operator's signature.....

Notes – see following page

Notes to report TM1-BC:

- 1 This report should be used for recording the thickness measurement of:
 - .1 All strength deck plating within the cargo length area.
 - .2 Keel, bottom shell plating and bilge plating within the cargo length area.
 - .3 Side shell plating that is all wind and water strakes within the cargo length area.
 - .4 Side shell plating that is selected wind and water strakes outside the cargo length area.
- 2 The strake position should be clearly indicated as follows:
 - .1 For strength deck, indicate the number of the strake of plating inboard from the stringer plate.
 - .2 For bottom plating, indicate the number of the strake of plating outboard from the keel plate.
 - .3 For side shell plating, give number of the strake of plating below sheerstrake and letter as shown on shell expansion.
- 3 Only the deck plating strakes outside line of openings should be recorded.
- 4 Measurements should be taken at the forward and aft areas of all plates.
- 5 The single measurements recorded should represent the average of multiple measurements.
- 6 The maximum allowable diminution could be stated in an attached document.

Report on thickness measurement of shell and deck plating (one, two or three transverse sections) (TM2-BC(i))

Ship's name..... IMO number..... Class Identity No..... Report No.....

STRENGTH DECK AND SHEERSTRAKE PLATING																									
STRAKE POSITION	FIRST TRANSVERSE SECTION AT FRAME NUMBER....							SECOND TRANSVERSE SECTION AT FRAME NUMBER....							THIRD TRANSVERSE SECTION AT FRAME NUMBER....										
	No. or letter	Orig. thk (mm)	Gauged		Diminution P		Diminution S	Max allow. dimin. (mm)	No. or letter	Orig. thk (mm)	Gauged		Diminution P		Diminution S	Max allow. dimin. (mm)	No. or letter	Orig. thk (mm)	Gauged		Diminution P		Diminution S	Max allow. dimin. (mm)	
			P	S	mm	%					mm	%	P	S					mm	%	mm	%			P
Stringer plate																									
1st strake inboard																									
2nd																									
3rd																									
4th																									
5th																									
6th																									
7th																									
8th																									
9th																									
10th																									
11th																									
12th																									
13th																									
14th																									
centre strake																									
sheerstrake																									
TOPSIDE																									
TOTAL																									

Operator's signature.....

Notes – see following page

Notes to report TM2-BC(i):

- 1 This report should be used for recording the thickness measurement of strength deck plating and sheer-strake plating transverse sections:

One, two or three sections within the cargo length area, comprising structural items (1), (2) and (3) as shown on the diagram of typical transverse sections (appendix 3).
- 2 Only the deck plating outside the line of openings should be recorded.
- 3 The topside area comprises deck plating, stringer plate and sheer-strake (including rounded gunwales).
- 4 The exact frame station of measurement should be stated.
- 5 The single measurements recorded should represent the average of multiple measurements.
- 6 The maximum allowable diminution could be stated in an attached document.

Report on thickness measurement of shell and deck plating (one, two or three transverse sections) (TM2-BC(ii))

Ship's name..... IMO number..... Class Identity No..... Report No.....

	SHELL PLATING																								
STRAKE POSITION	FIRST TRANSVERSE SECTION AT FRAME NUMBER....							SECOND TRANSVERSE SECTION AT FRAME NUMBER....							THIRD TRANSVERSE SECTION AT FRAME NUMBER....										
	No. or letter	Orig. thk (mm)	Gauged		Diminution P		Diminution S	Max allow. dimin. (mm)	No. or letter	Orig. thk (mm)	Gauged		Diminution P		Diminution S	Max allow. dimin. (mm)	No. or letter	Orig. thk (mm)	Gauged		Diminution P		Diminution S	Max allow. dimin. (mm)	
			P	S	mm	%					mm	%	P	S					mm	%	mm	%			P
1st below sheerstrake																									
2nd																									
3rd																									
4th																									
5th																									
6th																									
7th																									
8th																									
9th																									
10th																									
11th																									
12th																									
13th																									
14th																									
15th																									
16th																									
17th																									
18th																									
19th																									
20th																									
keel strake																									
BOTTOM TOTAL																									

Operator's signature.....

Notes – see following page

Notes to report TM2-BC(ii):

1 This report should be used for recording the thickness measurements of shell plating at transverse sections:

One, two or three sections within the cargo length area comprising structural items (4), (5), (6), and (7) as shown on the diagram of typical transverse sections (appendix 3).

2 The bottom area comprises keel, bottom and bilge plating.

3 The exact frame station of measurement should be stated.

4 The single measurements recorded should represent the average of multiple measurements.

5 The maximum allowable diminution could be stated in an attached document.

Report on thickness measurement of longitudinal members (one, two or three transverse sections) (TM3-BC)

Ship's name..... IMO number..... Class Identity No..... Report No.....

STRUCTURAL MEMBER	FIRST TRANSVERSE SECTION AT FRAME NUMBER....							SECOND TRANSVERSE SECTION AT FRAME NUMBER....							THIRD TRANSVERSE SECTION AT FRAME NUMBER....									
	Item no.	Orig. thk (mm)	Gauged		Diminution P		Diminution S	Max allow. dimin. (mm)	Item no.	Orig. thk (mm)	Gauged		Diminution P		Diminution S	Max allow. dimin. (mm)	Item no.	Orig. thk (mm)	Gauged		Diminution P		Diminution S	Max allow. dimin. (mm)
			P	S	mm	%					mm	%	P	S					mm	%	mm	%		

Operator's signature.....

Notes – see following page

Notes to report TM3-BC:

- 1 This report should be used for recording the thickness measurement of longitudinal members at transverse sections:

One, two or three sections within the cargo length area, comprising the appropriate structural items (8) to (20) as shown on the diagram of typical transverse sections (appendix 3).

- 2 The exact frame station of measurement should be stated.
- 3 The single measurements recorded should represent the average of multiple measurements.
- 4 The maximum allowable diminution could be stated in an attached document.

Report on thickness measurement of transverse structural members in the double bottom, hopper side and topside water ballast tanks (TM4-BC)

Ship's name..... IMO number..... Class Identity No..... Report No.....

TANK DESCRIPTION:									
LOCATION OF STRUCTURE:									
STRUCTURAL MEMBER	ITEM	Original thickness (mm)	Gauged		Diminution P		Diminution S		Maximum allowable diminution (mm)
			Port	Starboard	mm	%	mm	%	

Operator's signature.....

Notes – see following page

Notes to report TM4-BC:

- 1 This report should be used for recording the thickness measurement of transverse structural members, comprising appropriate structural items (23) to (25) as shown on the diagram of typical transverse sections (appendix 3).
- 2 Guidance for areas of measurement is indicated in appendix 3.
- 3 The single measurements recorded should represent the average of multiple measurements.
- 4 The maximum allowable diminution could be stated in an attached document.

Report on thickness measurement of cargo hold transverse bulkheads (TM5-BC)

Ship's name..... IMO number..... Class Identity No..... Report No.....

LOCATION OF STRUCTURE:						FRAME NUMBER:		
STRUCTURAL COMPONENT (PLATING/STIFFENER)	Original thickness (mm)	Gauged		Diminution P		Diminution S		Maximum allowable diminution (mm)
		Port	Starboard	mm	%	mm	%	

Operator's signature.....

Notes – see following page

Notes to report TM5-BC:

- 1 This report form should be used for recording the thickness measurement of cargo hold transverse bulkheads.
- 2 Guidance for areas of measurement is indicated in appendix 3.
- 3 The single measurements recorded should represent the average of multiple measurements.
- 4 The maximum allowable diminution could be stated in an attached document.

Report on thickness measurement of miscellaneous structural members (TM6-BC)

Ship's name..... IMO number..... Class Identity No..... Report No.....

STRUCTURAL MEMBER:								SKETCH
LOCATION OF STRUCTURE:								
DESCRIPTION	Orig. thk. (mm)	Gauged		Diminution P		Diminution S		Max. allow. dimin. (mm)
		P	S	mm	%	mm	%	

Operator's signature.....

Notes – see following page

Notes to report TM6-BC:

- 1 This report should be used for recording the thickness measurement of miscellaneous structural members including structural items (28), (29), (30) and (31) as shown on the diagram of typical transverse sections in appendix 3.
- 2 Guidance for areas of measurement is indicated in appendix 3.
- 3 The single measurements recorded should represent the average of multiple measurements.
- 4 The maximum allowable diminution could be stated in an attached document.

Notes to report TM7-BC(i):

- 1 This report should be used for recording the thickness measurement of:
 - cargo hold transverse frames; and
 - structural item number (34) as shown on the diagram of typical transverse section indicating longitudinal and transverse members in appendix 3.
- 2 Guidance for areas of measurement is indicated in appendix 3.
- 3 The single measurements recorded should represent the average of multiple measurements.
- 4 The maximum allowable diminution could be stated in an attached document.

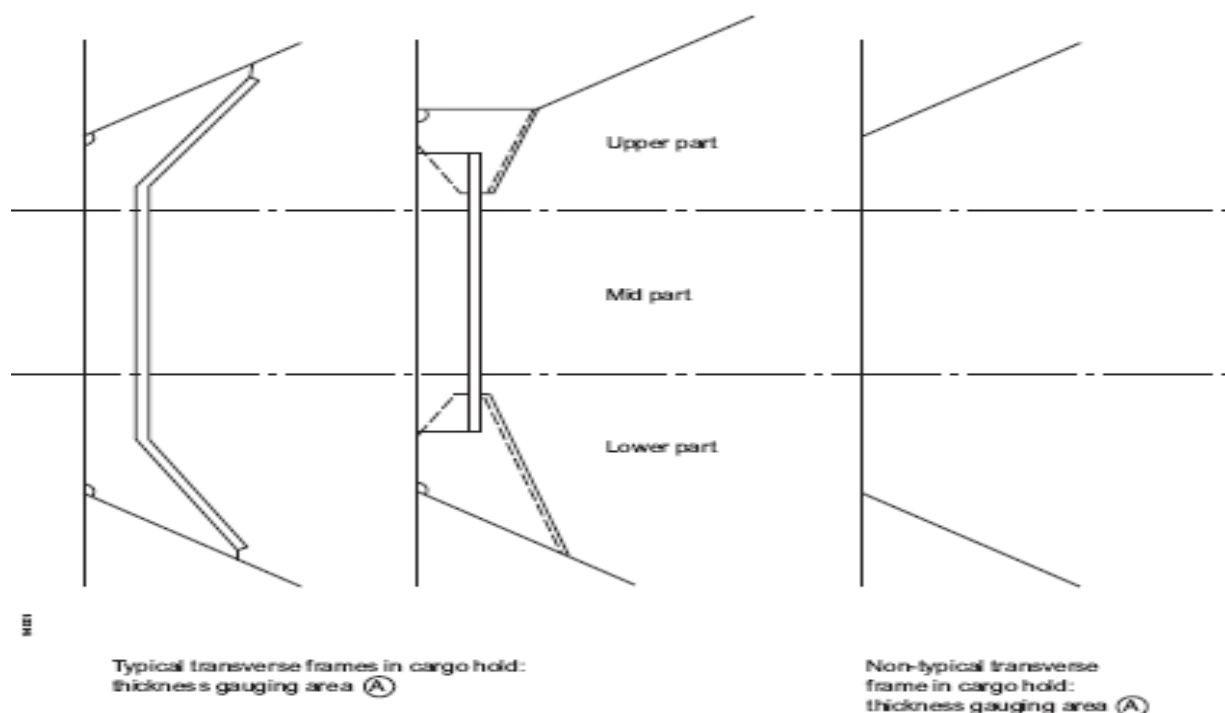

Report on thickness measurement of cargo hold side shell frames (TM7-BC(ii))

Ship's name..... IMO number..... Class identity No..... Report No.....

CARGO HOLD NO.:					Side:					(Port / stb.)															
FRAME No	ZONE A						Zone B						ZONE C						ZONE D						
	Org. Thk.	t _{REN}	t _{COAT}	t _M	Diminution		Org. Thk.	t _{REN}	t _{COAT}	t _M	Diminution		Org. Thk.	t _{REN}	t _{COAT}	t _M	Diminution		Org. Thk.	t _{REN}	t _{COAT}	t _M	Diminution		
	mm	mm	mm	mm	mm	%	mm	mm	mm	mm	mm	%	mm	mm	mm	mm	mm	%	mm	mm	mm	mm	mm	%	
-	-	-	-	-	-	-	-	-	-	-	-	-	-	-	-	-	-	-	-	-	-	-	-	-	-
-	-	-	-	-	-	-	-	-	-	-	-	-	-	-	-	-	-	-	-	-	-	-	-	-	-
-	-	-	-	-	-	-	-	-	-	-	-	-	-	-	-	-	-	-	-	-	-	-	-	-	-
-	-	-	-	-	-	-	-	-	-	-	-	-	-	-	-	-	-	-	-	-	-	-	-	-	-
-	-	-	-	-	-	-	-	-	-	-	-	-	-	-	-	-	-	-	-	-	-	-	-	-	-
-	-	-	-	-	-	-	-	-	-	-	-	-	-	-	-	-	-	-	-	-	-	-	-	-	-
-	-	-	-	-	-	-	-	-	-	-	-	-	-	-	-	-	-	-	-	-	-	-	-	-	-
-	-	-	-	-	-	-	-	-	-	-	-	-	-	-	-	-	-	-	-	-	-	-	-	-	-
-	-	-	-	-	-	-	-	-	-	-	-	-	-	-	-	-	-	-	-	-	-	-	-	-	-
-	-	-	-	-	-	-	-	-	-	-	-	-	-	-	-	-	-	-	-	-	-	-	-	-	-
-	-	-	-	-	-	-	-	-	-	-	-	-	-	-	-	-	-	-	-	-	-	-	-	-	-
-	-	-	-	-	-	-	-	-	-	-	-	-	-	-	-	-	-	-	-	-	-	-	-	-	-
-	-	-	-	-	-	-	-	-	-	-	-	-	-	-	-	-	-	-	-	-	-	-	-	-	-
-	-	-	-	-	-	-	-	-	-	-	-	-	-	-	-	-	-	-	-	-	-	-	-	-	-
-	-	-	-	-	-	-	-	-	-	-	-	-	-	-	-	-	-	-	-	-	-	-	-	-	-
-	-	-	-	-	-	-	-	-	-	-	-	-	-	-	-	-	-	-	-	-	-	-	-	-	-

Operator's signature.....

Notes on report TM7-BC(ii):

1 This report should be used for recording the thickness measurement of:

Cargo hold transverse frames for application of resolution MSC.168(79).

2 Guidance for areas of measurement is provided in annex 15.

3 Symbols should be applied as follows:

t_M = thickness as measured, in mm

t_{REN} = thickness at which renewal is required in accordance with paragraph 2.1.2 of annex 2 to resolution MSC.168(79)

t_{COAT} = $0.75 \cdot$ (thickness, in mm, as required by annex 1 to resolution MSC.168(79), in paragraph 3 for frame webs and in paragraph 4 for upper and lower brackets).

4 The maximum allowable diminution could be stated in an attached document.

Appendix 3

GUIDANCE ON THICKNESS MEASUREMENT

Typical transverse section indicating longitudinal and transverse members

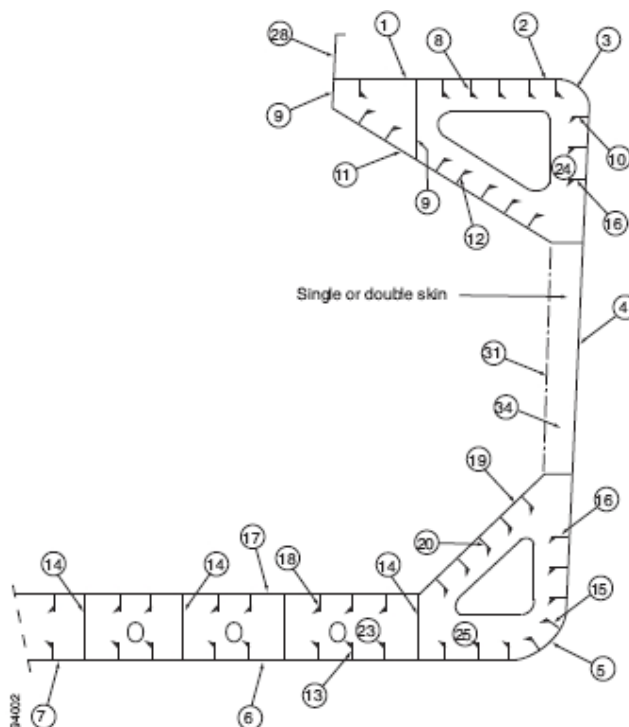

REPORT ON TMS-BC
1 Strength deck plating
2 Stringer plate
3 Sheenstrate
4 Side shell plating
5 Bilge plating
6 Bottom shell plating
7 Keel plate

REPORT ON TMS-BC
8 Deck longitudinals
9 Deck girders
10 Sheenstrate longitudinals
11 Topside tank sloping plating
12 Topside tank sloping plating longitudinals
13 Bottom longitudinals
14 Bottom girders
15 Bilge longitudinals
16 Side shell longitudinals
17 Inner bottom plating
18 Inner bottom longitudinals
19 Hopper side plating
20 Hopper side longitudinals
21
22

REPORT ON TM4-BC
23 Double-bottom tank floors
24 Topside tank transverses
25 Hopper side tank transverses
26
27

REPORT ON TM6-BC
28 Hatch coamings
29 Deck plating between hatches
30 Hatch covers
31 Inner bulkhead plating
32
33

REPORT ON TM7-BC
34 Hold frames or diaphragms

Transverse section outline

(To be used for longitudinal and transverse members where the typical transverse section is not applicable)

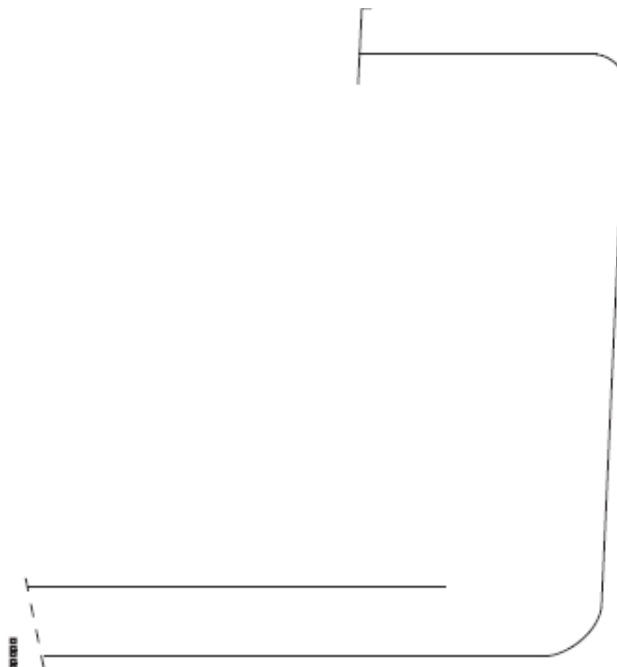

REPORT ON TM2-RC	
1	Strength deck plating
2	Stringer plate
3	Sheenstrate
4	Side shell plating
5	Bilge plating
6	Bottom shell plating
7	Keel plate

REPORT ON TM3-RC	
8	Deck longitudinals
9	Deck girders
10	Sheenstrate longitudinals
11	Topside tank sloping plating
12	Topside tank sloping plating longitudinals
13	Bottom longitudinals
14	Bottom girders
15	Bilge longitudinals
16	Side shell longitudinals
17	Inner bottom plating
18	Inner bottom longitudinals
19	Hopper side plating
20	Hopper side longitudinals
21	
22	

REPORT ON TM4-RC	
23	Doublebottom tank floors
24	Topside tank transverses
25	Hopper side tank transverses
26	
27	

REPORT ON TM5-RC	
28	Hatch coamings
29	Deck plating between hatches
30	Hatch covers
31	Inner bulkhead plating
32	
33	

REPORT ON TM7-RC	
34	Hold frames or diaphragms

Close-up survey and thickness measurement areas

(Typical areas for thickness measurement of cargo hold frames, structural members and transverse bulkheads in association with close-up survey requirements)

Typical transverse section
Areas (A), (B) and (D)

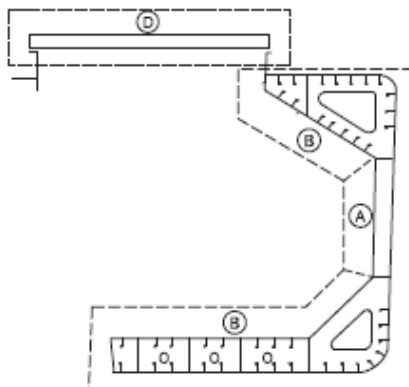

Thickness to be reported on TM3-BC, TM4-BC, TM6-BC and TM7-BC as appropriate

A cargo hold transverse bulkhead
Area (C)

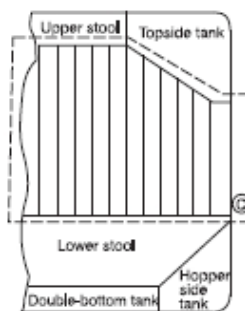

Thickness to be reported on TM5-BC

Typical areas of deck plating inside line of hatch openings between cargo hold hatches

Area (E)

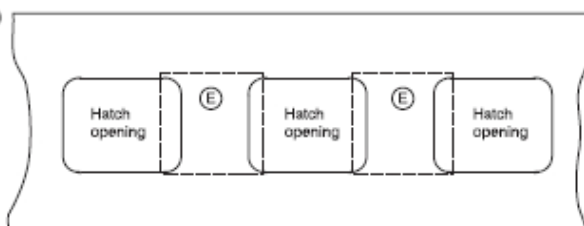

54004

Thickness to be reported on TM6-BC

ANNEX 9

GUIDELINES FOR TECHNICAL ASSESSMENT IN CONJUNCTION WITH THE PLANNING OF ENHANCED SURVEYS FOR BULK CARRIERS – RENEWAL SURVEY HULL**1 Introduction**

These Guidelines contain information and suggestions concerning technical assessments which may be of use in conjunction with the planning of enhanced renewal surveys of bulk carriers. As indicated in 5.1.5, the Guidelines are a recommended tool which may be invoked at the discretion of an Administration, when considered necessary and appropriate, in conjunction with the preparation of the required survey programme.

2 Purpose and principles**2.1 Purpose**

The purpose of the technical assessments described in these Guidelines is to assist in identifying critical structural areas, nominating suspect areas and in focusing attention on structural elements or areas of structural elements which may be particularly susceptible to, or evidence a history of, wastage or damage. This information may be useful in nominating locations, areas, holds and tanks for thickness measurement, close-up survey and tank testing.

Critical structural areas are locations which have been identified from calculations to require monitoring or from the service history of the subject ship or from similar or sister ships (if available) to be sensitive to cracking, buckling or corrosion which would impair the structural integrity of the ship.

2.2 Minimum requirements

These Guidelines may not be used to reduce the requirements of annexes 1 and 2 and paragraph 2.7 of part A for close-up survey, thickness measurement and tank testing, respectively, which are, in all cases, to be complied with as a minimum.

2.3 Timing

As with other aspects of survey planning, the technical assessments described in these Guidelines should be completed by the owner or operator in cooperation with the Administration well in advance of the commencement of the renewal survey, i.e. prior to commencing the survey and normally at least 12 to 15 months before the survey's completion due date.

2.4 Aspects to be considered

2.4.1 Technical assessments, which may include quantitative or qualitative evaluation of relative risks of possible deterioration, of the following aspects of a particular ship may be used as a basis for the nomination of holds, tanks and areas for survey:

- .1 design features such as stress levels on various structural elements, design details and extent of use of high-tensile steel;

- .2 former history with respect to corrosion, cracking, buckling, indents and repairs for the particular ship as well as similar vessels, where available; and
- .3 information with respect to types of cargo carried, protection of tanks, and condition of coating, if any, of holds and tanks.

2.4.2 Technical assessments of the relative risks of susceptibility to damage or deterioration of various structural elements and areas should be judged and decided on the basis of recognized principles and practices, such as may be found in reference 3.

3 Technical assessment

3.1 General

3.1.1 There are three basic types of possible failure which may be the subject of technical assessment in connection with planning of surveys: corrosion, cracks and buckling. Contact damages are not normally covered by the survey plan since indents are usually noted in memoranda and assumed to be dealt with as a normal routine by surveyors.

3.1.2 Technical assessments performed in conjunction with the survey planning process should, in principle, be as shown schematically in figure 1 which depicts, schematically, how technical assessments can be carried out in conjunction with the survey planning process. The approach is based on an evaluation of experience and knowledge basically related to:

- .1 design; and
- .2 corrosion.

3.1.3 The design should be considered with respect to structural details which may be susceptible to buckling or cracking as a result of vibration, high stress levels or fatigue.

3.1.4 Corrosion is related to the ageing process, and is closely connected with the quality of corrosion protection at new building, and subsequent maintenance during the service life. Corrosion may also lead to cracking and/or buckling.

3.2 Methods

3.2.1 Design details

3.2.1.1 Damage experience related to the ship in question and similar ships, where available, is the main source of information to be used in the process of planning. In addition, a selection of structural details from the design drawings should be included.

3.2.1.2 Typical damage experience to be considered will consist of:

- .1 number, extent, location and frequency of cracks; and
- .2 location of buckles.

3.2.1.3 This information may be found in the survey reports and/or the owner's files, including the results of the owner's own inspections. The defects should be analysed, noted and marked on sketches.

3.2.1.4 In addition, general experience should be utilized. For example, figure 2 shows typical locations in bulk carriers which experience has shown may be susceptible to structural damage. Also, reference should be made to reference 3 which contains a catalogue of typical damages and proposed repair methods for various bulk carrier structural details.

3.2.1.5 Such figures should be used together with a review of the main drawings, in order to compare with the actual structure and search for similar details which may be susceptible to damage. An example is shown in figure 3.

3.2.1.6 The review of the main structural drawings, in addition to using the above-mentioned figures, should include checking typical design details where cracking has been experienced. The factors contributing to damage should be carefully considered.

3.2.1.7 The use of high-tensile steel (HTS) is an important factor. Details showing good service experience where ordinary, mild steel has been used may be more susceptible to damage when HTS, and its higher associated stresses, are utilized. There is extensive and, in general, good experience with the use of HTS for longitudinal material in deck and bottom structures. Experience in other locations, where the dynamic stresses may be higher, is less favourable, e.g. side structures.

3.2.1.8 In this respect, stress calculations of typical and important components and details, in accordance with relevant methods, may prove useful and should be considered.

3.2.1.9 The selected areas of the structure identified during this process should be recorded and marked on the structural drawings to be included in the survey programme.

3.2.2 *Corrosion*

3.2.2.1 In order to evaluate relative corrosion risks, the following information is generally to be considered:

- .1 usage of tanks, holds and spaces;
- .2 condition of coatings;
- .3 cleaning procedures;
- .4 previous corrosion damage;
- .5 ballast use and time for cargo holds;
- .6 risk of corrosion in cargo holds and ballast tanks; and
- .7 location of ballast tanks adjacent to heated fuel oil tanks.

3.2.2.2 Reference 2 gives definitive examples which can be used for judging and describing coating condition, using typical pictures of conditions.

3.2.2.3 For bulk carriers, reference 3 should be used as the basis for the evaluation, together with the age of the ship and relevant information on the anticipated condition of the ship as derived from the information collected in order to prepare the survey programme.

3.2.2.4 The various tanks, holds and spaces should be listed with the corrosion risks nominated accordingly.

3.2.3 *Locations for close-up survey and thickness measurement*

3.2.3.1 On the basis of the table of corrosion risks and the evaluation of design experience, the locations for initial close-up survey and thickness measurement (sections) may be nominated.

3.2.3.2 The sections subject to thickness measurement should normally be nominated in tanks, holds and spaces where corrosion risk is judged to be the highest.

3.2.3.3 The nomination of tanks, holds and spaces for close-up survey should, initially, be based on highest corrosion risk, and should always include ballast tanks. The principle for the selection should be that the extent is increased by age or where information is insufficient or unreliable.

References

- 1 TSCF, Guidance Manual for the Inspection and Condition Assessment of Tanker Structures, 1986.
- 2 TSCF, Condition Evaluation and Maintenance of Tanker Structures, 1992.
- 3 IACS, Bulk Carriers: Guidelines for Surveys, Assessment and Repair of Hull Structures, 2007.

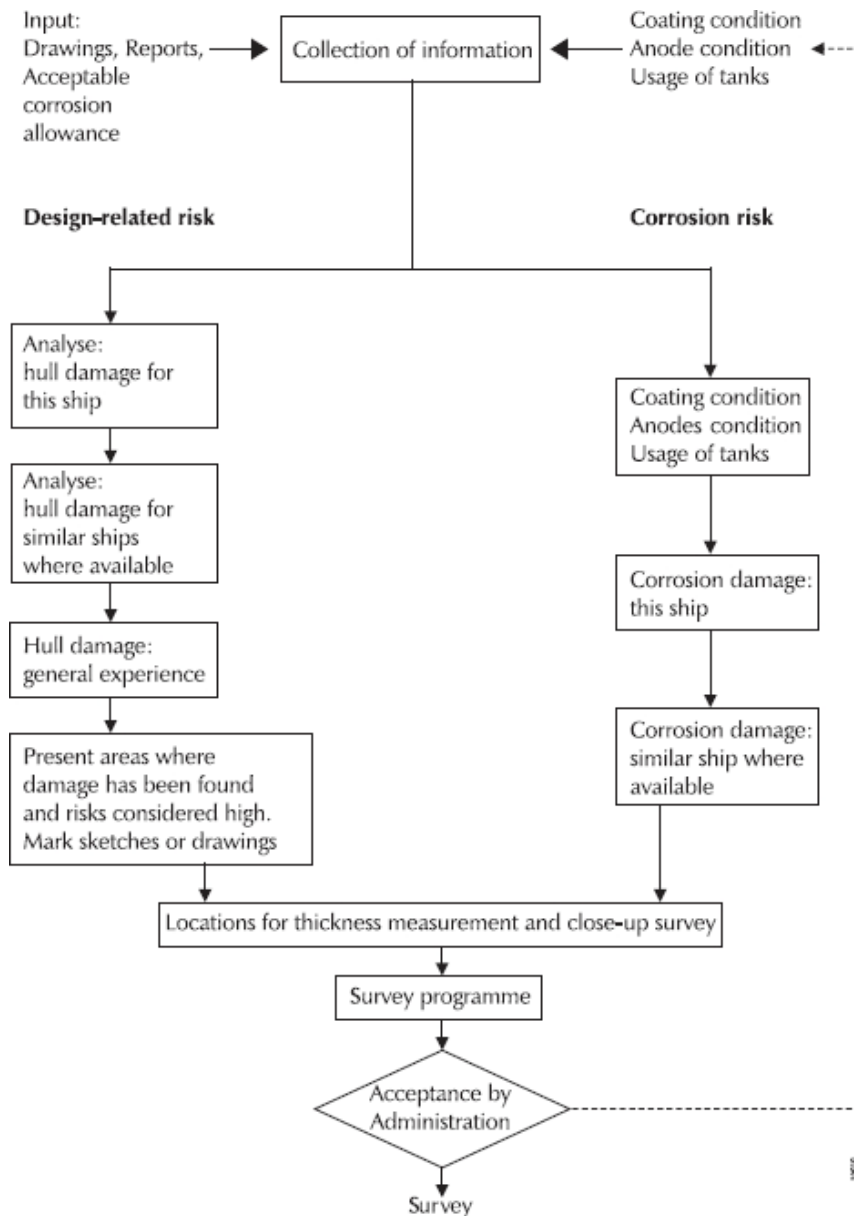

Figure 1 – Technical assessment and the survey planning process

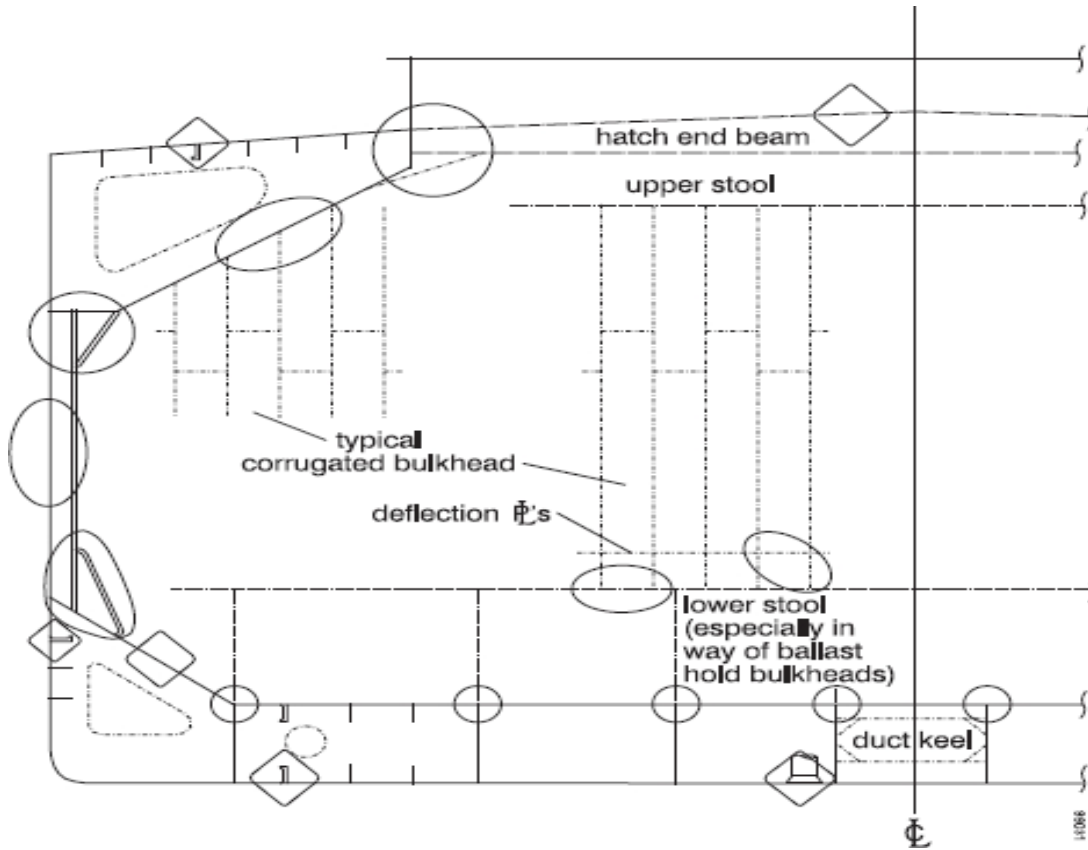

Figure 2 – Typical locations susceptible to structural damage or corrosion

BULK CARRIERS		Guidelines for Surveys, Assessment and Repair of Hull Structure	
Part 1	Cargo hold region	Example No.	
Area 3	Cargo hold side structure	1-a	
Detail of damage		Fractures in brackets at termination of frame	
Sketch of damage		Sketch of repair	
<p>Separate bracket configuration</p>		<p>S=Snipped end</p>	
Notes on possible cause of damage		Notes on repairs	
<p>1. This type of damage is caused due to stress concentration.</p>		<ol style="list-style-type: none"> For small fractures, e. g. hairline fractures, the fracture can be veed-out, ground, examined by NDT for fractures, and rewelded. For larger/significant fractures consideration is to be given to cropping and partly renewing/renewing the frame brackets. If renewing the brackets, end of frames can be snipped to soften them. If felt prudent, soft toes are to be incorporated at the boundaries of the bracket to the hopper plating. Attention to be given to the structure in wing tanks in way of the extended bracket arm. i.e. reinforcement provided in line with the bracket. 	

Figure 3 – Typical damage and repair example (reproduced from reference 3)

ANNEX 10

**REQUIREMENTS FOR EXTENT OF THICKNESS MEASUREMENT AT AREAS
OF SUBSTANTIAL CORROSION**

**Renewal survey of bulk carriers within the cargo area
Shell plating**

Structural member	Extent of measurement	Pattern of measurement
1 Bottom and side shell plating	a Suspect plate, plus four adjacent plates	a Five-point pattern for each panel between longitudinals
	b See other tables for particulars on gauging in way of tanks and cargo holds	
2 Bottom/side shell longitudinals	Minimum of three longitudinals in way of suspect areas	Three measurements in line across web Three measurements on flange

Transverse bulkheads in cargo holds

Structural member	Extent of measurement	Pattern of measurement
1 Lower stool	a Transverse band within 25 mm of welded connection to inner bottom	a Five-point pattern between stiffeners over 1 m length
	b Transverse band within 25 mm of welded connection to shelf plate	b Ditto
2 Transverse bulkhead	a Transverse band at approximately mid-height	a Five-point pattern over 1 m ² of plating
	b Transverse band at part of bulkhead adjacent to upper deck or below upper stool shelf plate (for those ships fitted with upper stools)	b Five-point pattern over 1 m ² of plating

Deck structure including cross strips, main cargo hatchways, hatch covers, coamings and topside tanks

Structural member	Extent of measurement	Pattern of measurement
1 Cross-deck strip plating	Suspect cross-deck strip plating	Five-point pattern between under deck stiffeners over 1 m length
2 Under-deck stiffeners	a Transverse members	a Five-point pattern at each end and mid-span
	b Longitudinal member	b Five-point pattern on both web and flange
3 Hatch covers	a Side and end skirts, each three locations	a Five-point pattern at each location
	b Three longitudinal bands, outboard strakes (2) and centerline strake (1)	b Five-point measurement each band
4 Hatch coamings	Each side and end of coaming, one band lower third, one band upper two-thirds of coaming	Five-point measurement each band, i.e. end or side coaming
5 Topside water ballast tanks	a Watertight transverse bulkheads	
	i lower third of bulkhead	i five-point pattern over 1 m ² of plating
	ii upper two-thirds of bulkhead	ii five-point pattern over 1 m ² of plating
	iii stiffeners	iii five-point pattern over 1 m length
	b Two representative swash transverse bulkheads	
	i lower third of bulkhead	i five-point pattern over 1 m ² of plating
ii upper two-thirds of bulkhead	ii five-point pattern over 1 m ² of plating	
iii stiffeners	iii five-point pattern over 1 m length	
c Three representative bays of slope plating		
	i lower third of tank	i five-point pattern over 1 m ² of plating
ii upper two-thirds of tank	ii five-point pattern over 1 m ² of plating	
d Longitudinals, suspect and adjacent	d	d Five-point pattern both web and flange over 1 m length
6 Main deck plating	Suspect plates and adjacent (4)	Five-point pattern over 1 m ² of plating
7 Main deck longitudinals	Minimum of three longitudinals where plating measured	Five-point pattern on both web and flange over 1 m length
8 Web frames/transverses	Suspect plates	Five-point pattern over 1 m ²

Double-bottom and hopper structure

Structural member	Extent of measurement	Pattern of measurement
1 Inner/double-bottom plating	Suspect plate plus all adjacent plates	Five-point pattern for each panel between longitudinals over 1 m length
2 Inner/double-bottom longitudinals	Three longitudinals where plates measured	Three measurements in line across web, and three measurements on flange
3 Longitudinal girders or transverse floors	Suspect plates	Five-point pattern over about 1 m ²
4 Watertight bulkheads (WT floors)	a Lower third of tank	a Five-point pattern over 1 m ² of plating
	b Upper two thirds of tank	b Five-point pattern alternate plates over 1 m ² of plating
5 Web frames	Suspect plate	Five-point pattern over 1 m ² of plating
6 Bottom/side shell longitudinals	Minimum of three longitudinals in way of suspect areas	Three measurements in line across web, and three measurements on flange

Cargo holds

Structural member	Extent of measurement	Pattern of measurement
1 Side shell frames	Suspect frame and each adjacent	a At each end and mid span: five-point pattern of both web and flange
		b Five-point pattern within 25 mm of welded attachment to both shell and lower slope plate

ANNEX 11

GUIDELINES FOR THE GAUGING OF THE VERTICALLY CORRUGATED TRANSVERSE WATERTIGHT BULKHEAD BETWEEN HOLDS NOS. 1 AND 2

1 Gauging is necessary to determine the general condition of the structure and to define the extent of possible repairs and/or reinforcements of the vertically corrugated transverse watertight bulkhead for verification of the compliance with the bulk carrier bulkhead and double-bottom strength standards, defined in regulation XII/1.7 of the Convention.

2 Taking into account the buckling model specified in the bulk carrier bulkhead and double-bottom strength standards, defined in regulation XII/1.7 of the Convention, in the evaluation of strength of the bulkhead, it is essential to determine the thickness diminution at the critical levels shown in figures 1 and 2 of this annex.

3 The gauging should be carried out at the levels as described below. To adequately assess the scantlings of each individual vertical corrugation, each corrugation flange, web, shedder plate and gusset plate within each of the levels given below should be gauged.

Level (a) Ships without lower stool (see figure 1):

Locations:

- The mid-breadth of the corrugation flanges at approximately 200 mm above the line of shedder plates;
- The middle of gusset plates between corrugation flanges, where fitted;
- The middle of the shedder plates;
- The mid-breadth of the corrugation webs at approximately 200 mm above the line of shedder plates.

Level (b) Ships with lower stool (see figure 2):

Locations:

- The mid-breadth of the corrugation flanges at approximately 200 mm above the line of shedder plates;
- The middle of gusset plates between corrugation flanges, where fitted;
- The middle of the shedder plates;
- The mid-breadth of the corrugation webs at approximately 200 mm above the line of shedder plates.

Level (c) Ships with or without lower stool (see figures 1 and 2):

Locations:

- The mid-breadth of the corrugation flanges and webs at about the mid-height of the corrugation.

4 Where the thickness changes within the horizontal levels, the thinner plate should be gauged.

5 Steel renewal and/or reinforcement should comply with the bulk carrier bulkhead and double-bottom strength standards, defined in regulation XII/1.7 of the Convention.

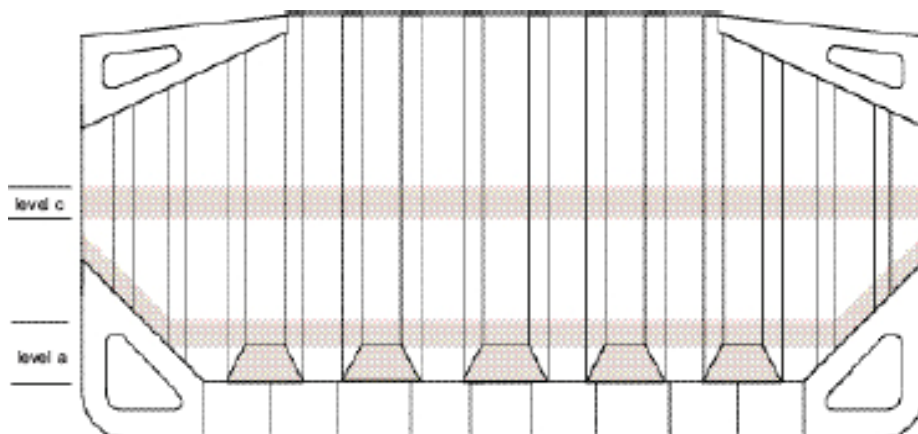

Figure 1 – Ships without lower stool

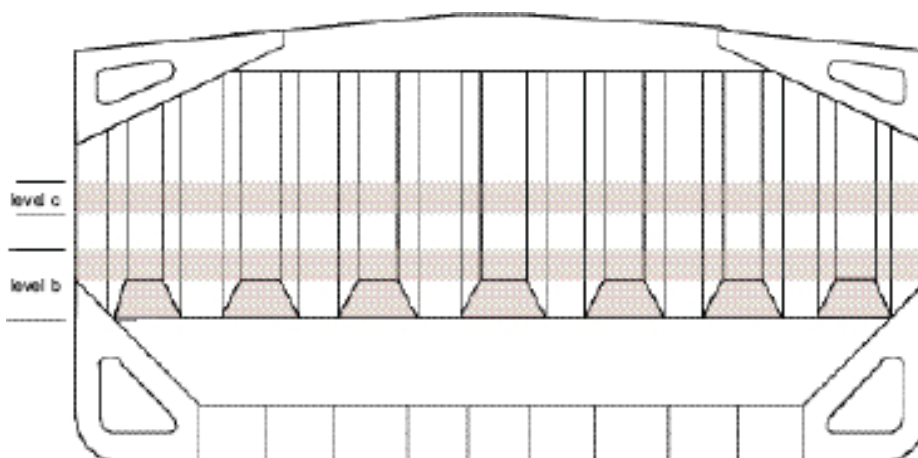

Figure 2 – Ships with lower stool

ANNEX 12

ADDITIONAL ANNUAL SURVEY REQUIREMENTS FOR THE FOREMOST CARGO HOLD OF SHIPS SUBJECT TO REGULATION XII/9 OF THE CONVENTION**1 General**

In the case of bulk carriers over five years of age, the annual survey should include, in addition to the requirements of the annual surveys prescribed in chapter 3 of the present Code, an examination of the following items.

2 Extent of survey**2.1 For bulk carriers of 5 to 15 years of age**

2.1.1 An overall survey of the foremost cargo hold, including close-up survey of sufficient extent, minimum 25 per cent of frames, should be carried out to establish the condition of:

- .1 shell frames including their upper and lower end attachments, adjacent shell plating, and transverse bulkheads; and
- .2 areas found to be suspect areas at the previous renewal survey.

2.1.2 Where considered necessary by the surveyor as a result of the overall and close-up survey as described in 2.1.1 above, the survey should be extended to include a close-up survey of all of the shell frames and adjacent shell plating of the cargo hold.

2.2 For bulk carriers exceeding 15 years of age

An overall survey of the foremost cargo hold, including close-up survey should be carried out to establish the condition of:

- .1 all shell frames including their upper and lower end attachments, adjacent shell plating, and transverse bulkheads; and
- .2 areas found to be suspect areas at the previous renewal survey.

3 Extent of thickness measurement

3.1 Thickness measurement should be carried out to an extent sufficient to determine both general and local corrosion levels at areas subject to close-up survey, as described in 2.1 and 2.2 above. The minimum requirement for thickness measurements are areas found to be suspect areas at the previous renewal survey. Where substantial corrosion is found, the extent of thickness measurements should be increased with the requirements of annex 10.

3.2 The thickness measurement may be dispensed with provided the surveyor is satisfied by the close-up survey, there is no structural diminution and the protective coating, where applied, remains effective.

4 Special consideration

Where the protective coating, as referred to in the explanatory note below, in the foremost cargo hold is found to be in GOOD condition, the extent of close-up surveys and thickness measurements may be specially considered.

Explanatory note:

For existing bulk carriers, where owners may elect to coat or recoat cargo holds as noted above, consideration may be given to the extent of the close-up and thickness measurement surveys. Prior to the coating of cargo holds of existing ships, scantlings should be ascertained in the presence of a surveyor.

ANNEX 13

STRENGTH OF CARGO HATCH COVER SECURING ARRANGEMENTS FOR BULK CARRIERS

1 Securing devices

The strength of securing devices should comply with the following requirements:

- .1 Panel hatch covers should be secured by appropriate devices (bolts, wedges or similar) suitably spaced alongside the coamings and between cover elements. Arrangement and spacing should be determined with due attention to the effectiveness for weathertightness, depending upon the type and the size of the hatch cover, as well as on the stiffness of the cover edges between the securing devices.

- .2 The net sectional area of each securing device should not be less than:

$$A = 1.4 a / f (\text{cm}^2)$$

where:

- a = spacing between securing devices not to be taken less than 2 m
 f = $(\sigma_Y / 235)^e$
 σ_Y = specified minimum upper yield stress in N/mm^2 of the steel used for fabrication, not to be taken greater than 70 per cent of the ultimate tensile strength
 e = 0.75 for $\sigma_Y > 235$
 1.0 for $\sigma_Y \leq 235$.

Rods or bolts should have a net diameter not less than 19 mm for hatchways exceeding 5 m^2 in area.

- .3 Between cover and coaming and at cross-joints, a packing line pressure sufficient to obtain weathertightness should be maintained by the securing devices. For packing line pressures exceeding 5 N/mm, the cross section area should be increased in direct proportion. The packing line pressure should be specified.

- .4 The cover edge stiffness should be sufficient to maintain adequate sealing pressure between securing devices. The moment of inertia, I , of edge elements should not be less than:

$$I = 6 p a^4 (\text{cm}^4)$$

where:

- p = packing line pressure in N/mm, minimum 5 N/mm
 a = spacing in metres of securing devices.

- .5 Securing devices should be of reliable construction and securely attached to the hatchway coamings, decks or covers. Individual securing devices on each cover are to have approximately the same stiffness characteristics.

- .6 Where rod cleats are fitted, resilient washers or cushions should be incorporated.
- .7 Where hydraulic cleating is adopted, a positive means should be provided to ensure that it remains mechanically locked in the closed position in the event of failure of the hydraulic system.

2 Stoppers

2.1 Nos. 1 and 2 hatch covers should be effectively secured, by means of stoppers, against the transverse forces arising from a pressure of 175 kN/m².

2.2 No.2 hatch covers should be effectively secured, by means of stoppers, against the longitudinal forces acting on the forward end arising from a pressure of 175 kN/m².

2.3 No.1 hatch cover should be effectively secured, by means of stoppers, against the longitudinal forces acting on the forward end arising from a pressure of 230 kN/m². This pressure may be reduced to 175 kN/m² if a forecastle is fitted.

2.4 The equivalent stress in stoppers and their supporting structures and calculated in the throat of the stopper welds should not exceed the allowable value of $0.8 \sigma_Y$.

3 Materials and welding

Where stoppers or securing devices are fitted to comply with this annex, they should be manufactured of materials, including welding electrodes, to the satisfaction of the Administration.

ANNEX 14

PROCEDURAL REQUIREMENTS FOR THICKNESS MEASUREMENTS**1 General**

Thickness measurements required in the context of hull structural surveys, if not carried out by the society itself, should be witnessed by a surveyor. The attendance of the surveyor should be recorded. This also applies to thickness measurements taken during voyages.

2 Survey meeting

2.1 Prior to commencement of the renewal or intermediate survey, a meeting should be held between the attending surveyor(s), the owner's representative(s) in attendance, the thickness measurement firm's representative(s) and the master of the ship or an appropriately qualified representative appointed by the master or Company so as to ensure the safe and efficient execution of the surveys and thickness measurements to be carried out on board.

2.2 Communication with the thickness measurement operator(s) and owner's representative(s) should be agreed during the meeting, with respect to the following:

- .1 reporting of thickness measurements on regular basis; and
- .2 prompt notification to the surveyor in case of findings such as:
 - .1 excessive and/or extensive corrosion or pitting/grooving of any significance;
 - .2 structural defects like buckling, fractures and deformed structures;
 - .3 detached and/or holed structure; and
 - .4 corrosion of welds.

2.3 The survey report should indicate where and when the meeting took place and who attended (the name of the surveyor(s), the owner's representative(s) and the thickness measurement firm's representative(s)).

3 Monitoring of the thickness measurement process on board

3.1 The surveyor should decide final extent and location of thickness measurements after overall survey of representative spaces on board.

3.2 In case the owner prefers to commence the thickness measurements prior to the overall survey, then the surveyor should advise that the planned extent and locations of thickness measurements are subject to confirmation during the overall survey. Based on findings, the surveyor may require additional thickness measurements to be taken.

3.3 The surveyor should direct the gauging operation by selecting locations such that readings taken represent, on average, the condition of the structure for that area.

3.4 Thickness measurements taken mainly to evaluate the extent of corrosion, which may affect the hull girder strength, should be carried out in a systematic manner such that all longitudinal structural members are gauged, as required.

3.5 Where thickness measurements indicate substantial corrosion or wastage in excess of allowable diminution, the surveyor should direct locations for additional thickness measurements in order to delineate areas of substantial corrosion and to identify structural members for repairs/renewals.

3.6 Thickness measurements of structures in areas where close-up surveys are required should be carried out simultaneously with close-up survey.

4 Review and verification

4.1 Upon completion of the thickness measurements, the surveyor should confirm that no further gaugings are needed, or specify additional gaugings.

4.2 Where these guidelines allow the extent of thickness measurements to be reduced after special considerations by the surveyor, these special considerations should be reported, where appropriate.

4.3 In case thickness measurements are partly carried out, the extent of remaining thickness measurements should be reported for the use of the next surveyor.

ANNEX 15

**GUIDELINES FOR THE THICKNESS MEASUREMENTS OF SIDE SHELL FRAMES
AND BRACKETS IN SINGLE-SIDE SKIN BULK CARRIERS REQUIRED
TO COMPLY WITH RESOLUTION MSC.168(79)****1 General**

Thickness measurements should be conducted to determine the general condition of the structure and to define the extent of possible steel renewals or other measures for the webs and flanges of side shell frames and brackets for verification of the compliance with resolution MSC.168(79).

2 Zones of side shell frames and brackets

2.1 For the purpose of steel renewal, sand blasting and coating, four zones A, B, C and D are defined as shown in figure 1.

2.2 Zones A and B should be considered the most critical zones.

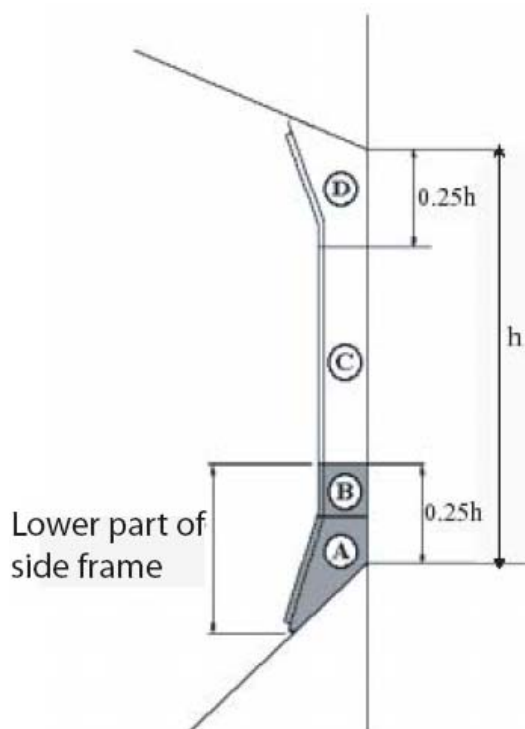

Figure 1 – Zones of side shell frames and brackets

3 Pitting and grooving

3.1 Pits can grow in a variety of shapes, some of which should be ground before assessment.

3.2 Pitting corrosion may be found under coating blisters, which should be removed before inspection.

3.3 To measure the remaining thickness of pits or grooving the normal ultrasonic transducer (generally 10 mm diameter) will not suffice. A miniature transducer (3 to 5 mm diameter) should be used. Alternatively the firm conducting the thickness measurement should use a pit gauge to measure the depth of the pits and grooving and calculate the remaining thickness.

Assessment based upon area

3.4 This is the method specified in paragraph 2.5 of annex 2 to resolution MSC.168(79) and is based upon the intensity determined from figure 2 below.

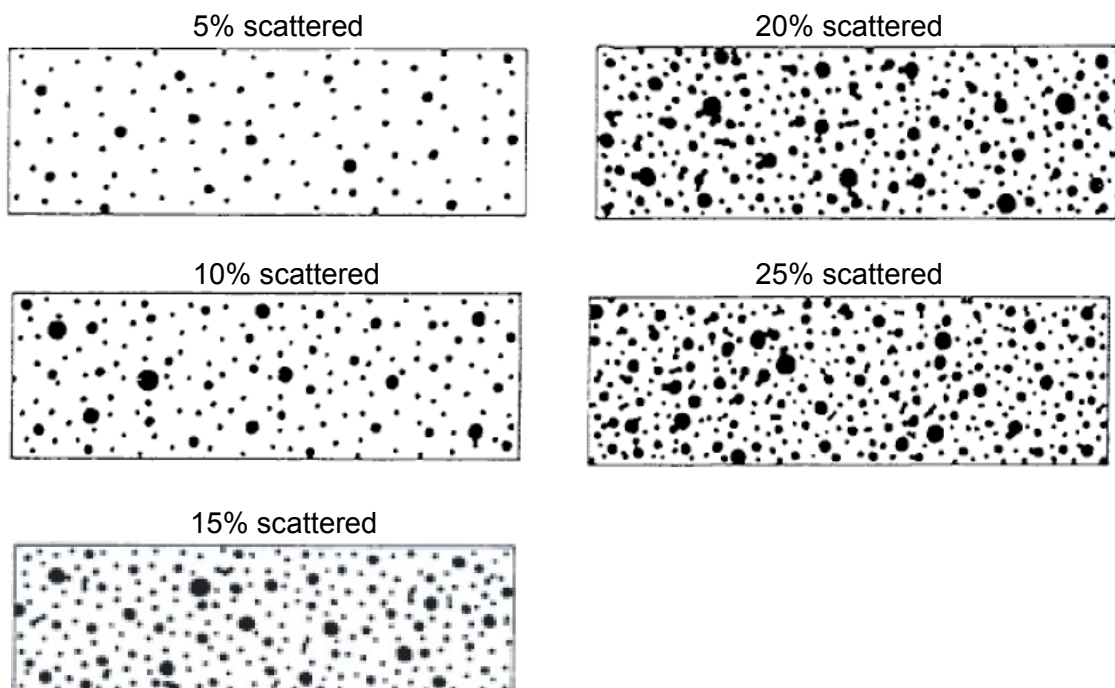

Figure 2 – Pitting intensity diagrams (from 5 to 25% intensity)

3.5 If pitting intensity is higher than 15 per cent in an area (see figure 2), then thickness measurements should be taken to determine the extent of the pitting corrosion. The 15 per cent is based upon pitting or grooving on only one side of the plate.

3.6 In cases where pitting is evident as defined above (exceeding 15%) then an area of 300 mm diameter or more (or, where this is impracticable on the frame flange or the side shell, hopper tank plating or topside tank plating attached to the side frame, an equivalent rectangular area), at the most pitted part, should be cleaned to bare metal, and the thickness measured in way of the five deepest pits within the cleaned area. The least thickness measured in way of any of these pits is to be taken as the thickness to be recorded.

3.7 The minimum acceptable remaining thickness in any pit or groove is equal to:

- .1 75 per cent of the as built thickness, for pitting or grooving in the cargo hold side frame webs and flanges.
- .2 70 per cent of the as built thickness, for pitting or grooving in the side shell, hopper tank and topside tank plating attached to the cargo hold side frame, over a width up to 30 mm from each side of it.

4 Thickness measurement methodology

4.1 Numbers of side frames to be measured should be equivalent to those of the renewal survey or intermediate survey corresponding to the ship's age. Representative thickness measurements should be taken for each zone as specified below.

4.2 Special consideration to the extent of the thickness measurements may be given by the Administration or organization recognized by the Administration, if the structural members show no thickness diminution with respect to the as built thicknesses and the coating is found in "as new" condition (i.e. without breakdown or rusting).

4.3 Where thickness measurement readings close to the criteria are found, the number of hold frames to be measured should be increased.

4.4 If renewal or other measures according to resolution MSC.168(79) should be applied on individual frames in a hold, then all frames in that hold should have thickness measurements taken.

4.5 There is a variety of construction methods used for side shell frames in bulk carriers. Some have faceplates (T sections) on the side shell frames, some have flanged plates and some have bulb plates. The use of faceplates and flanged sections is considered similar for thickness measurement purposes in that both the web and faceplate or web and flange plate should be measured. If bulb plate has been used, then web of the bulb plate should be measured in the normal manner and the sectional modulus should be specially considered if required.

Gaugings for Zones A, B and D

Web plating

4.6 The pattern for thickness measurements in Zones A, B and D should be a five-point pattern. See figure 3. The five-point pattern should be over the depth of the web and the same area vertically. The thickness measurement report should reflect the average reading.

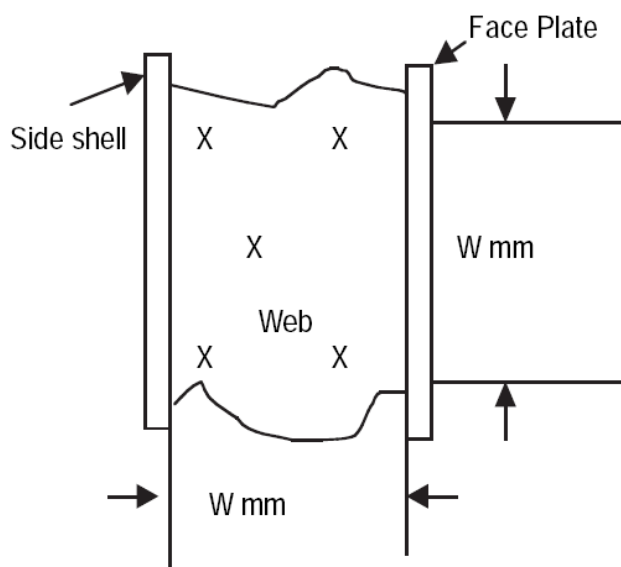

Figure 3 – Typical five-point pattern on the web plate

Thickness measurements for Zone C

Web plating

4.7 Depending on the condition of the web in way of Zone C, the web may be measured by taking three readings over the length of Zone C and averaging them. The average reading should be compared with the allowable thickness. If the web plating has general corrosion then this pattern should be expanded to a five-point pattern as noted above.

Thickness measurements for section a) and b) (flanges and side shell plating)

4.8 Where the lower bracket length or depth does not meet the requirements in annex 1 to resolution MSC.168(79), thickness measurements should be taken at sections a) and b) to calculate the actual section modulus required in paragraph 3.4 of annex 2 to resolution MSC.168(79) (see figure 4). At least two readings on the flange/faceplate should be taken on each side of the frame (i.e. fore and aft) in way of section a) and section b).

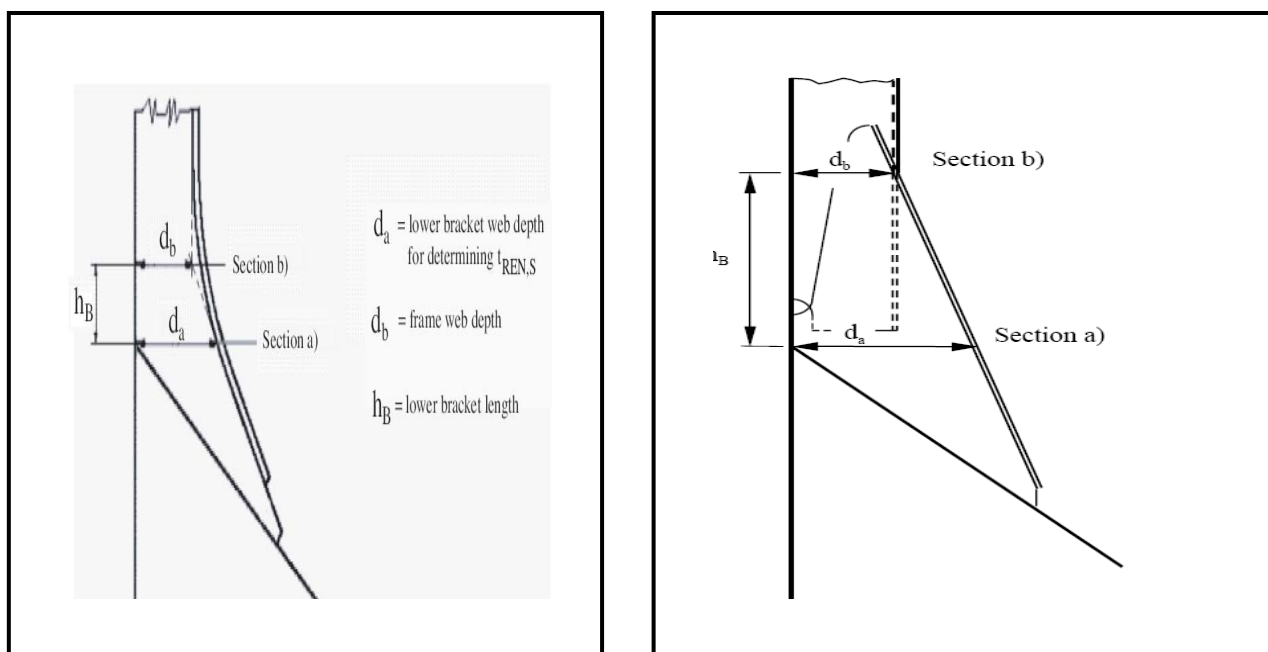

Figure 4 – Sections a) and b)

5 Report on thickness measurement of cargo hold frames

See form TM7-BC(ii) as contained in appendix 2 to annex 8.

References

IACS, Blue Books: Unified Requirement UR Z10.2 Hull Surveys of Bulk Carriers, Revision 27 2009, Annex V.

Resolution MSC.168(79) on Standards and criteria for side structures of bulk carriers of single-side skin construction.

Part B**CODE ON THE ENHANCED PROGRAMME OF INSPECTIONS DURING SURVEYS OF BULK CARRIERS HAVING DOUBLE-SIDE SKIN CONSTRUCTION****1 General****1.1 Application⁵**

1.1.1 The Code should apply to all self-propelled double-side skin bulk carriers of 500 gross tonnage and above.

1.1.2 The Code should apply to surveys of hull structure and piping systems in way of cargo holds, cofferdams, pipe tunnels, void spaces, fuel oil tanks within the cargo length area and all ballast tanks.

1.1.3 The Code contains the minimum extent of examination, thickness measurements and tank testing. The survey should be extended when substantial corrosion and/or structural defects are found and include additional close-up survey when necessary.

1.1.4 For bulk carriers with hybrid cargo hold arrangements, e.g. with some cargo holds of single-side skin and others of double-side skin, the requirements of part A of annex A apply to cargo holds of single-side skin.

1.1.5 The surveys should be carried out during the surveys prescribed by regulation I/10 of the Convention.

1.2 Definitions

1.2.1 *Double-side skin bulk carrier* is a ship which is constructed generally with single deck, topside tanks and hopper side tanks in cargo spaces, and is intended primarily to carry dry cargo in bulk including ore carriers and combination carriers, in which all cargo holds are bounded by a double-side skin (regardless of the width of the wing space).⁶

1.2.2 *Ballast tank* is a tank which is used solely for salt water ballast or, where applicable, a space which is used for both cargo and salt water ballast will be treated as a ballast tank when substantial corrosion has been found in that space. A double-side tank should be considered, for survey purposes, as a separate tank even if it is in connection to either the topside tank or the hopper side tank.

1.2.3 *Spaces* are separate compartments including holds, tanks, cofferdams and void spaces bounding cargo holds, decks and the outer hull.

1.2.4 *Overall survey* is a survey intended to report on the overall condition of the hull structure and determine the extent of additional close-up surveys.

⁵ The intention of the Code is to ensure that an appropriate level of review of plans and documents is conducted and consistency in application is attained. Such evaluation of survey reports, survey programmes, planning documents, etc., should be carried out at the managerial level of the Administration or organization recognized by the Administration.

⁶ For double-side skin combination carriers, additional requirements are specified in the Guidelines on the enhanced programme of inspections during surveys for oil tankers, set out in part A of annex B.

1.2.5 *Close-up survey* is a survey where the details of structural components are within the close visual inspection range of the surveyor, i.e. normally within reach of hand.

1.2.6 *Transverse section* is the cross section of the hull perpendicular to the ship's centerline and includes all longitudinal members such as plating, longitudinals and girders at the deck sides, bottom, inner bottom, hopper sides, inner sides, top wing inner sides and longitudinal bulkheads.

1.2.7 *Representative spaces* are those which are expected to reflect the condition of other spaces of similar type and service and with similar corrosion prevention systems. When selecting representative spaces, account should be taken of the service and repair history on board and identifiable critical structural areas and/or suspect areas.

1.2.8 *Suspect areas* are locations showing substantial corrosion and/or are considered by the surveyor to be prone to rapid wastage.

1.2.9 *Substantial corrosion* is an extent of corrosion such that assessment of corrosion pattern indicates a wastage in excess of 75 per cent of allowable margins, but within acceptable limits. For ships built under the IACS Common Structural Rules, substantial corrosion is an extent of corrosion such that the assessment of the corrosion pattern indicates a gauged (or measured) thickness between $t_{net} + 0.5$ mm and t_{net} .

1.2.10 *A corrosion prevention system* is normally considered a full hard protective coating. Hard protective coating should usually be epoxy coating or equivalent. Other coating systems which are neither soft nor semi-hard coatings, may be considered acceptable as alternatives provided that they are applied and maintained in compliance with the manufacturer's specifications.

1.2.11 *Coating condition* is defined as follows:

GOOD condition with only minor spot rusting;

FAIR condition with local breakdown of coating at edges of stiffeners and weld connections and/or light rusting over 20 per cent or more of areas under consideration, but less than as defined for POOR condition;

POOR condition with general breakdown of coating over 20 per cent or more of areas or hard scale at 10 per cent or more of areas under consideration.

1.2.12 *Critical structural areas* are locations which have been identified from calculations to require monitoring or from the service history of the subject ship or from similar or sister ships (if applicable) to be sensitive to cracking, buckling or corrosion which would impair the structural integrity of the ship.

1.2.13 *Cargo length area* is that part of the ship which includes all cargo holds and adjacent areas including fuel tanks, cofferdams, ballast tanks and void spaces.

1.2.14 *Intermediate survey* is a survey carried out either at the second or third annual survey or between these surveys.

1.2.15 *A prompt and thorough repair* is a permanent repair completed at the time of survey to the satisfaction of the surveyor, therein removing the need for the imposition of any associated condition of classification or recommendation.

1.2.16 *Convention* means the International Convention for the Safety of Life at Sea, 1974, as amended.

1.2.17 *Specially considered* (in connection with close-up surveys and thickness measurements) means sufficient close-up inspection and thickness measurements are taken to confirm the actual average condition of the structure under the coating.

1.3 *Repairs*

1.3.1 Any damage in association with wastage over the allowable limits (including buckling, grooving, detachment or fracture), or extensive areas of wastage over the allowable limits, which affects or, in the opinion of the Administration, will affect the ship's structural, watertight or weathertight integrity, should be promptly and thoroughly (see 1.2.15) repaired. Areas which should be considered include:

- .1 side structure and side plating;
- .2 deck structure and deck plating;
- .3 bottom structure and bottom plating;
- .4 inner bottom structure and inner bottom plating;
- .5 inner side structure and inner side plating;
- .6 watertight or oiltight bulkheads;
- .7 hatch covers or hatch coamings; and
- .8 items in 3.3.10.

For locations where adequate repair facilities are not available, the Administration may allow the ship to proceed directly to a repair facility. This may require discharging the cargo and/or temporary repairs for the intended voyage.

1.3.2 Additionally, when a survey results in the identification of corrosion or structural defects, either of which, in the opinion of the Administration, will impair the ship's fitness for continued service, remedial measures should be implemented before the ship continues in service.

1.4 *Surveyors*

For bulk carriers of 20,000 tons deadweight and above, two surveyors should jointly carry out the first scheduled renewal survey after the bulk carrier passes 10 years of age (i.e. third renewal survey), and all subsequent renewal surveys and intermediate surveys. If the surveys are carried out by a recognized organization, the surveyors should be exclusively employed by such recognized organizations.

1.5 *Thickness measurements and close-up surveys*

In any kind of survey, i.e. renewal, intermediate, annual or other surveys having the scope of the foregoing ones, thickness measurements of structures in areas where close-up surveys are required should be carried out simultaneously with close-up surveys.

2 Renewal survey

2.1 General

2.1.1 The renewal survey may be commenced at the fourth annual survey and be progressed during the succeeding year with a view to completion by the fifth anniversary date.

2.1.2 As part of the preparation for the renewal survey, the survey programme should be dealt with in advance of the survey. The thickness measurement should not be held before the fourth annual survey.

2.1.3 The survey should include, in addition to the requirements of the annual survey, examination, tests and checks of sufficient extent to ensure that the hull and related piping, as required in 2.1.5, is in satisfactory condition and is fit for its intended purpose for the new period of validity of the Cargo Ship Safety Construction Certificate, subject to proper maintenance and operation and to periodical surveys being carried out at the due dates.

2.1.4 All cargo holds, ballast tanks, including double-bottom and double-side tanks, pipe tunnels, cofferdams and void spaces bounding cargo holds, decks and outer hull should be examined, and this examination should be supplemented by thickness measurement and testing, as required by 2.6 and 2.7, to ensure that the structural integrity remains effective. The examination should be sufficient to discover substantial corrosion, significant deformation, fractures, damages or other structural deterioration that may be present.

2.1.5 All piping systems within the above spaces should be examined and operationally tested under working pressure to attending surveyor's satisfaction to ensure that tightness and condition remain satisfactory.

2.1.6 The survey extent of ballast tanks converted to void spaces should be specially considered in relation to the requirements for ballast tanks.

2.1.7 Concurrent crediting to both intermediate survey and renewal survey for surveys and thickness measurements of spaces should not be acceptable.

2.2 Dry-dock survey

2.2.1 A survey in dry-dock should be a part of the renewal survey. There should be a minimum of two inspections of the outside of the ship's bottom during the five-year period of the certificate. In all cases, the maximum interval between bottom inspections should not exceed 36 months.

2.2.2 For ships of 15 years of age and over, inspection of the outside of the ship's bottom should be carried out with the ship in dry-dock. For ships of less than 15 years of age, alternate inspections of the ship's bottom not conducted in conjunction with the renewal survey may be carried out with the ship afloat. Inspection of the ship afloat should only be carried out when the conditions are satisfactory and the proper equipment and suitably qualified staff is available.

2.2.3 If a survey in dry-dock is not completed in conjunction with the enhanced survey during renewal survey or if the 36-month maximum interval referred to in 2.2.1 is not complied with, the Cargo Ship Safety Construction Certificate should cease to be valid until a survey in dry-dock is completed.

2.2.4 The overall and close-up survey and thickness measurements, as applicable, of the lower portions of the cargo holds and ballast tanks should be carried out in accordance with the applicable requirements for renewal survey, if not already performed.

Note: Lower portions of the cargo holds and ballast tanks are considered to be the parts below light ballast water line.

2.3 *Space protection*

2.3.1 Where provided, the condition of the corrosion prevention system of ballast tanks should be examined. For ballast tanks, excluding double-bottom tanks, where a hard protective coating is found in POOR condition as defined in 1.2.11, and it is not renewed, or where a soft or semi-hard coating has been applied, or where a hard protective coating has not been applied from the time of constructions, the tanks in question should be examined at annual intervals. Thickness measurements should be carried out as deemed necessary by the surveyor. When such breakdown of hard protective coating is found in water ballast double-bottom tanks and it is not renewed, or where a soft or semi-hard coating has been applied or where a hard protective coating has not been applied from the time of construction, the tanks in question may be examined at annual intervals. When considered necessary by the surveyor, or where extensive corrosion exists, thickness measurement should be carried out.

2.3.2 Where a hard protective coating is provided in cargo holds and is found in good condition, the extent of close-up surveys and thickness measurements may be specially considered.

2.4 *Hatch covers and coamings*

The hatch covers and coamings should be surveyed as follows:

2.4.1 A thorough inspection of the items listed in 3.3 should be carried out, in addition to all hatch covers and coamings.

2.4.2 Checking of the satisfactory operation of all mechanically operated hatch covers should be made, including:

- .1 stowage and securing in open condition;
- .2 proper fit and efficiency of sealing in closed condition; and
- .3 operational testing of hydraulic and power components, wires, chains and link drives.

2.4.3 The effectiveness of sealing arrangements of all hatch covers by hose testing or equivalent should be checked.

2.4.4 Thickness measurement of the hatch cover and coaming plating and stiffeners should be carried out as given in annex 2.

2.5 *Extent of overall and close-up surveys*

2.5.1 An overall survey of all tanks and spaces should be carried out at the renewal survey. Fuel oil tanks in the cargo length area should be surveyed as follows:

Renewal survey No.1	Renewal survey No.2	Renewal survey No.3	Renewal survey No.4 and subsequent
Age ≤ 5	5 < Age ≤ 10	10 < Age ≤ 15	15 < Age
None	One	Two	Half, minimum two
<p>Notes:</p> <ol style="list-style-type: none"> 1. These requirements apply to tanks of integral (structural) type. 2. If a selection of tanks is accepted to be examined, then different tanks should be examined at each renewal survey, on a rotational basis. 3. Peak tanks (all uses) should be examined internally at each renewal survey. 4. At renewal survey no.3 and subsequent renewal surveys, one deep tank for fuel oil in the cargo area should be included, if fitted. 			

2.5.2 The minimum requirements for close-up surveys at renewal surveys are given in annex 1, appendix 1 for double-side skin bulk carriers, excluding ore carriers, and in annex 1, appendix 2 for ore carriers respectively.

2.5.3 The surveyor may extend the close-up survey as deemed necessary taking into account the maintenance of the spaces under survey, the condition of the corrosion prevention system and where spaces have structural arrangements or details which have suffered defects in similar spaces or on similar ships according to available information.

2.5.4 For areas in spaces where hard protective coatings are found to be in a GOOD condition, the extent of close-up surveys according to annex 1 may be specially considered (refer also to 2.3.2).

2.6 *Extent of thickness measurements*

2.6.1 The minimum requirements for thickness measurements at the renewal survey are given in annex 2.

2.6.2 Representative thickness measurements to determine both general and local levels of corrosion in the transverse web frames in all water ballast tanks should be carried out. Thickness measurements should also be carried out to determine the corrosion levels on the transverse bulkhead plating. The extent of thickness measurements may be specially considered provided the surveyor is satisfied by the close-up examination that there is no structural diminution, and the hard protective coating where applied remains efficient.

2.6.3 Provisions for extended measurements for areas with substantial corrosion as defined in 1.2.9 are given in annex 10 and may be additionally specified in the survey programme as required by 5.1. These extended thickness measurements should be carried out before the survey is credited as completed. Suspect areas identified at previous surveys should be examined. Areas of substantial corrosion identified at previous surveys should have thickness measurements taken.

2.6.4 The surveyor may further extend the thickness measurements as deemed necessary.

2.6.5 For areas in tanks where hard protective coatings are found to be in GOOD condition as defined in 1.2.11, the extent of thickness measurements according to annex 2 may be specially considered by the Administration.

2.6.6 Transverse sections should be chosen where the largest reductions are suspected to occur or are revealed from deck plating measurements.

2.7 *Extent of tank pressure testing*

2.7.1 All boundaries of water ballast tanks, deep tanks and cargo holds used for water ballast within the cargo length area should be pressure tested. For fuel tanks, only representative tanks should be pressure tested.

2.7.2 The surveyor may extend the tank testing as deemed necessary.

2.7.3 Boundaries of ballast tanks should be tested with a head of liquid to the top of air pipes.

2.7.4 Boundaries of ballast holds should be tested with a head of liquid to near to the top of hatches.

2.7.5 Boundaries of fuel oil tanks should be tested with a head of liquid to the highest point that liquid will rise under service conditions. Tank testing of fuel oil tanks may be specially considered based on a satisfactory external examination of the tank boundaries and a confirmation from the master stating that the pressure testing has been carried out according to the requirements with satisfactory results.

2.7.6 The testing of double-bottom tanks and other spaces not designated for the carriage of liquid may be omitted, provided a satisfactory internal examination together with an examination of the tank top is carried out.

2.8 *Additional renewal survey requirements after determining compliance with regulations XII/12 and XII/13 of the Convention*

2.8.1 For ships complying with the requirements of regulation XII/12 of the Convention for hold, ballast and dry space water level detectors, the renewal survey should include an examination and a test of the water ingress detection system and of their alarms.

2.8.2 For ships complying with the requirements of regulation XII/13 of the Convention for the availability of pumping systems, the renewal survey should include an examination and a test of the means for draining and pumping ballast tanks forward of the collision bulkhead and bilges of dry spaces any part of which extends forward of the foremost cargo hold, and of their controls.

3 Annual survey

3.1 *General*

The annual survey should consist of an examination for the purpose of ensuring, as far as practicable, that the hull weather decks, hatch covers, coamings and piping are maintained in a satisfactory condition and should take into account the service history, condition and extent of the corrosion prevention system of ballast tanks and areas identified in the survey report file.

3.2 *Examination of the hull*

3.2.1 Examination of the hull plating and its closing appliances should be carried out as far as can be seen.

3.2.2 Examination of watertight penetrations should be carried out as far as practicable.

3.3 *Examination of weather decks, hatch covers and coamings*

3.3.1 It should be confirmed that no unapproved changes have been made to the hatch covers, hatch coamings and their securing and sealing devices since the last survey.

3.3.2 A thorough survey of cargo hatch covers and coamings is only possible by examination in the open as well as closed positions and should include verification of proper opening and closing operation. As a result, the hatch cover sets within the forward 25 per cent of the ship's length and at least one additional set, such that all sets on the ship are assessed at least once in every five-year period, should be surveyed open, closed and in operation to the full extent in each direction at each annual survey, including:

- .1 stowage and securing in open condition;
- .2 proper fit and efficiency of sealing in closed condition; and
- .3 operational testing of hydraulic and power components, wires, chains and link drives.

The closing of the covers should include the fastening of all peripheral, and cross joint cleats or other securing devices. Particular attention should be paid to the condition of hatch covers in the forward 25 per cent of the ship's length, where sea loads are normally greatest.

3.3.3 If there are indications of difficulty in operating and securing hatch covers, additional sets above those required by 3.3.2, at the discretion of the surveyor, should be tested in operation.

3.3.4 Where the cargo hatch securing system does not function properly, repairs should be carried out under the supervision of the Administration. Where hatch covers or coamings undergo substantial repairs, the strength of securing devices should be upgraded to comply with annex 11.

3.3.5 For each cargo hatch cover set, at each annual survey, the following items should be surveyed:

- .1 cover panels, including side plates, and stiffener attachments that may be accessible in the open position by close-up survey (for corrosion, cracks, deformation);
- .2 sealing arrangements of perimeter and cross joints (gaskets for condition and permanent deformation, flexible seals on combination carriers, gasket lips, compression bars, drainage channels and non-return valves);
- .3 clamping devices, retaining bars, cleating (for wastage, adjustment, and condition of rubber components);

- .4 closed cover locating devices (for distortion and attachment);
- .5 chain or rope pulleys;
- .6 guides;
- .7 guiderails and track wheels;
- .8 stoppers;
- .9 wires, chains, tensioners and gypsies;
- .10 hydraulic system, electrical safety devices and interlocks; and
- .11 end and interpanel hinges, pins and stools where fitted.

3.3.6 At each hatchway, at each annual survey, the coamings, with plating, stiffeners and brackets should be checked for corrosion, cracks and deformation, especially of the coaming tops including close-up survey.

3.3.7 Where considered necessary, the effectiveness of sealing arrangements may be proved by hose or chalk testing supplemented by dimensional measurements of seal compressing components.

3.3.8 Where portable covers, wooden or steel pontoons are fitted, the satisfactory condition of the following should be confirmed:

- .1 wooden covers and portable beams, carriers or sockets for the portable beam, and their securing devices;
- .2 steel pontoons, including close-up survey of hatch cover plating;
- .3 tarpaulins;
- .4 cleats, battens and wedges;
- .5 hatch securing bars and their securing devices;
- .6 loading pads/bars and the side plate edge;
- .7 guide plates and chocks; and
- .8 compression bars, drainage channels and drain pipes (if any).

3.3.9 The flame screens on vents to all bunker tanks should be examined.

3.3.10 Bunker and vent piping systems, including ventilators, should be examined.

3.4 *Examination of cargo holds*

3.4.1 For double-side skin bulk carriers of 10 to 15 years of age, the following should be carried out:

- .1 overall survey of two selected cargo holds;
- .2 when considered necessary by the surveyor, or where extensive corrosion exists, thickness measurement should be carried out. If the results of these thickness measurements indicate that substantial corrosion is found, the extent of thickness measurements should be increased in accordance with annex 10. These extended thickness measurements should be carried out before the survey is credited as complete. Suspect areas identified at previous surveys should be examined. Areas of substantial corrosion identified at previous surveys should have thickness measurements taken; and
- .3 all piping and penetrations in cargo holds, including overboard piping, should be examined.

3.4.2 For double-side skin bulk carriers over 15 years of age, the following should be carried out:

- .1 overall survey of all cargo holds;
- .2 when considered necessary by the surveyor, or where extensive corrosion exists, thickness measurement should be carried out. If the results of these thickness measurements indicate that substantial corrosion is found, the extent of thickness measurements should be increased in accordance with annex 10. These extended thickness measurements should be carried out before the survey is credited as complete. Suspect areas identified at previous surveys should be examined. Areas of substantial corrosion identified at previous surveys should have thickness measurements taken; and
- .3 all piping and penetrations in cargo holds, including overboard piping, should be examined.

3.5 *Examination of ballast tanks*

Examination of ballast tanks should be carried out when required as a consequence of the results of the renewal survey and intermediate survey. When considered necessary by the surveyor, or where extensive corrosion exists, thickness measurement should be carried out. If the results of these thickness measurements indicate that substantial corrosion is found, the extent of thickness measurements should be increased in accordance with annex 10. These extended thickness measurements should be carried out before the survey is credited as complete. Suspect areas identified at previous surveys should be examined. Areas of substantial corrosion identified at previous surveys should have thickness measurements taken.

3.6 *Additional annual survey requirements after determining compliance with regulations XII/12 and XII/13 of the Convention*

3.6.1 For ships complying with the requirements of regulation XII/12 of the Convention for hold, ballast and dry space water level detectors, the annual survey should include an examination and a test, at random, of the water ingress detection systems and of their alarms.

3.6.2 For ships complying with the requirements of regulation XII/13 of the Convention for the availability of pumping systems, the annual survey should include an examination and a test, of the means for draining and pumping ballast tanks forward of the collision bulkhead

and bilges of dry spaces any part of which extends forward of the foremost cargo hold, and of their controls.

4 Intermediate survey

4.1 General

4.1.1 Items that are additional to the requirements of the annual survey may be surveyed either at the second or third annual survey or between these surveys.

4.1.2 The extent of survey is dependent upon the age of the ship as specified in 4.2, 4.3 and 4.4.

4.1.3 Concurrent crediting to both intermediate survey and renewal survey for surveys and thickness measurements of spaces should not be acceptable.

4.2 Double-side skin bulk carriers 5 to 10 years of age

4.2.1 Ballast tanks

4.2.1.1 For tanks used for water ballast, an overall survey of representative tanks selected by the surveyor should be carried out. The selection should include fore and aft peak tanks and a number of other tanks, taking into account the total number and type of ballast tanks. If such overall survey reveals no visible structural defects, the examination may be limited to verification that the corrosion prevention system remains efficient.

4.2.1.2 Where POOR coating condition, corrosion or other defects are found in water ballast tanks or where a hard protective coating was not applied from the time of construction, the examination should be extended to other ballast tanks of the same type.

4.2.1.3 In ballast tanks other than double-bottom tanks, where a hard protective coating is found in POOR condition and it is not renewed, or where soft or semi-hard coating has been applied, or where a hard protective coating was not applied from the time of construction, the tanks in question should be examined and thickness measurements carried out as considered necessary at annual intervals. When such breakdown of hard protective coating is found in ballast double-bottom tanks, where a soft or semi-hard coating has been applied, or where a hard protective coating has not been applied, the tanks in question may be examined at annual intervals. When considered necessary by the surveyor, or where extensive corrosion exists, thickness measurements should be carried out.

4.2.1.4 In addition to the above requirements, areas found to be suspect areas at the previous renewal survey should be overall and close-up surveyed.

4.2.2 Cargo holds

4.2.2.1 An overall survey of all cargo holds should be carried out.

4.2.2.2 Where considered necessary by the surveyor as a result of the overall survey as described in 4.2.2.1, the survey should be extended to include a close-up survey those areas of the structure in the cargo holds selected by the surveyor.

4.2.3 *Extent of thickness measurements*

4.2.3.1 Thickness measurements should be carried out to an extent sufficient to determine both general and local corrosion levels at areas subject to close-up survey where required as per 4.2.2.2 and as provided in 4.2.1.4.

4.2.3.2 The extent of thickness measurements may be specially considered provided the surveyor is satisfied by the close-up survey that there is no structural diminution and the hard protective coatings are found to be in a GOOD condition.

4.2.3.3 Where substantial corrosion is found, the extent of thickness measurements should be increased in accordance with the requirements of annex 10. These extended thickness measurements should be carried out before the survey is credited as completed. Suspect areas identified at previous surveys should be examined. Areas of substantial corrosion identified at previous surveys should have thickness measurements taken.

4.2.3.4 Where the hard protective coating in cargo holds is found to be in GOOD condition, the extent of close-up surveys and thickness measurements may be specially considered.

4.3 *Double-side skin bulk carriers 10 to 15 years of age*

4.3.1 The requirements of the intermediate survey should be the same extent as the previous renewal survey as required in 2 and 5.1. However, internal examination of fuel oil tanks and pressure testing of all tanks are not required unless deemed necessary by the attending surveyor.

4.3.2 In application of 4.3.1, the intermediate survey may be commenced at the second annual survey and be progressed during the succeeding year with a view to completion at the third annual survey in lieu of the application of 2.1.1.

4.3.3 In application of 4.3.1, an underwater survey may be considered in lieu of the requirements of 2.2.

4.4 *Double-side skin bulk carriers exceeding 15 years of age*

4.4.1 The requirements of the intermediate survey should be to the same extent as the previous renewal survey required in 2 and 5.1. However, internal examination of fuel tanks and pressure testing of all tanks are not required unless deemed necessary by the attending surveyor.

4.4.2 In application of 4.4.1, the intermediate survey may be commenced at the second annual survey and be progressed during the succeeding year with a view to completion at the third annual survey in lieu of the application of 2.1.1.

4.4.3 In application of 4.4.1, a survey in dry-dock should be part of the intermediate survey. The overall and close-up surveys and thickness measurements, as applicable, of the lower portions of the cargo holds and water ballast tanks should be carried out in accordance with the applicable requirements for intermediate surveys, if not already performed.

Note: Lower portions of the cargo holds and ballast tanks are considered to be the parts below light ballast water line.

5 Preparations for survey

5.1 Survey programme

5.1.1 The owner in cooperation with the Administration should work out a specific survey programme prior to the commencement of any part of:

- .1 the renewal survey; and
- .2 the intermediate survey for double-side skin bulk carriers over 10 years of age.

The survey programme should be in a written format based on the information in annex 4A. The survey should not commence until the survey programme has been agreed.

5.1.1.1 Prior to the development of the survey programme, the survey planning questionnaire should be completed by the owner based on the information set out in annex 4B, and forwarded to the Administration.

5.1.1.2 The survey programme at intermediate survey may consist of the survey programme at the previous renewal survey supplemented by the condition evaluation report of that renewal survey and later relevant survey reports.

5.1.1.3 The survey programme should be worked out taking into account any amendments to the survey requirements after the last renewal survey carried out.

5.1.2 In developing the survey programme, the following documentation should be collected and consulted with a view to selecting tanks, holds, areas and structural elements to be examined:

- .1 survey status and basic ship information;
- .2 documentation on board, as described in 6.2 and 6.3;
- .3 main structural plans (scantlings drawings), including information regarding use of high-tensile steels (HTS);
- .4 relevant previous survey and inspection reports from both the classification society and the owner;
- .5 information regarding the use of ship's holds and tanks, typical cargoes and other relevant data;
- .6 information regarding corrosion prevention level on the new building; and
- .7 information regarding the relevant maintenance level during operation.

5.1.3 The submitted survey programme should account for, and comply, as a minimum, with the provisions of annexes 1 and 2 and 2.7 for close-up survey, thickness measurement and tank testing, respectively, and should include relevant information, including at least:

- .1 basic ship information and particulars;

-
- .2 main structural plans (scantling drawings), including information regarding use of high-tensile steels (HTS);
 - .3 plan of holds and tanks;
 - .4 list of holds and tanks with information on use, protection and condition of coating;
 - .5 conditions for survey (e.g. information regarding hold and tank cleaning, gas-freeing, ventilation, lighting, etc.);
 - .6 provisions and methods for access to structures;
 - .7 equipment for surveys;
 - .8 nomination of holds and tanks and areas for close-up survey (see 2.5);
 - .9 nomination of sections for thickness measurement (see 2.6);
 - .10 nomination of tanks for testing (see 2.7); and
 - .11 damage experience related to ship in question.

5.1.4 The Administration should advise the owner of the maximum acceptable structural corrosion diminution levels applicable to the ship.

5.1.5 Use may also be made of the Guidelines for technical assessment in conjunction with the planning of enhanced surveys for double-side skin bulk carriers, contained in annex 9. These Guidelines are a recommended tool which may be invoked at the discretion of the Administration, when considered necessary and appropriate, in conjunction with the preparation of the required survey programme.

5.2 *Conditions for survey*

5.2.1 The owner should provide the necessary facilities for a safe execution of the survey.

5.2.2 In order to enable the attending surveyors to carry out the survey, provisions for proper and safe access, should be agreed between the owner and the Administration.

5.2.3 Details of the means of access should be provided in the survey planning questionnaire.

5.2.4 In cases where the provisions of safety and required access are judged by the attending surveyors not to be adequate, the survey of the spaces involved should not proceed.

5.2.5 Cargo holds, tanks and spaces should be safe for access. Cargo holds, tanks and spaces should be gas free and properly ventilated. Prior to entering a tank, void or enclosed space, it should be verified that the atmosphere in the tank is free from hazardous gas and contains sufficient oxygen.

5.2.6 In preparation for survey and thickness measurements and to allow for a thorough examination, all spaces should be cleaned including removal from surfaces of all loose accumulated corrosion scale. Spaces should be sufficiently clean and free from water, scale,

dirt, oil residues, etc., to reveal corrosion, deformation, fractures, damages or other structural deterioration as well as the condition of the coating. However, those areas of structure whose renewal has already been decided by the owner need only be cleaned and descaled to the extent necessary to determine the limits of the areas to be renewed.

5.2.7 Sufficient illumination should be provided to reveal corrosion, deformation, fractures, damages or other structural deterioration as well as the condition of the coating.

5.2.8 Where soft or semi-hard coatings have been applied, safe access should be provided for the surveyor to verify the effectiveness of the coating and to carry out an assessment of the conditions of internal structures which may include spot removal of the coating. When safe access cannot be provided, the soft or semi-hard coating should be removed.

5.2.9 The surveyor(s) should always be accompanied by, at least, one responsible person, assigned by the owner, experienced in tank and enclosed spaces inspection. In addition, a back-up team of at least two experienced persons should be stationed at the hatch opening of the tank or space that is being surveyed. The back-up team should continuously observe the work in the tank or space and should keep life-saving and evacuation equipment ready for use.

5.2.10 A communication system should be arranged between the survey party in the cargo hold, tank or space being examined, the responsible officer on deck and, as the case may be, the navigation bridge. The communication arrangements should be maintained throughout the survey.

5.3 *Access to structures⁷*

5.3.1 For overall survey, means should be provided to enable the surveyor to examine the structure in a safe and practical way.

5.3.2 For close-up survey, one or more of the following means for access, acceptable to the surveyor, should be provided:

- .1 permanent staging and passages through structures;
- .2 temporary staging and passages through structures;
- .3 lifts and moveable platforms;
- .4 portable ladders;
- .5 boats or rafts; and
- .6 other equivalent means.

5.4 *Equipment for survey*

5.4.1 Thickness measurements should normally be carried out by means of ultrasonic test equipment. The accuracy of the equipment should be proven to the surveyor as required.

⁷

Refer to the Guidelines on the means of access to structures for inspection and maintenance of oil tankers and bulk carriers (MSC/Circ.686).

5.4.2 One or more of the following fracture detection procedures may be required if deemed necessary by the surveyor:

- .1 radiographic equipment;
- .2 ultrasonic equipment;
- .3 magnetic particle equipment; and
- .4 dye penetrant.

5.4.3 Explosimeter, oxygen-meter, breathing apparatus, lifelines, riding belts with rope and hook and whistles together with instructions and guidance on their use should be made available during the survey. A safety checklist should be provided.

5.4.4 Adequate and safe lighting should be provided for the safe and efficient conduct of the survey.

5.4.5 Adequate protective clothing should be made available and used (e.g. safety helmet, gloves, safety shoes, etc.) during the survey.

5.5 *Surveys at sea or at anchorage*

5.5.1 Surveys at sea or at anchorage may be accepted provided the surveyor is given the necessary assistance from the personnel on board. Necessary precautions and procedures for carrying out the survey should be in accordance with 5.1, 5.2, 5.3 and 5.4.

5.5.2 A communication system should be arranged between the survey party in the spaces under examination and the responsible officer on deck. This system should also include the personnel in charge of ballast pump handling if boats or rafts are used.

5.5.3 Surveys of tanks or applicable holds by means of boats or rafts may only be undertaken with the agreement of the surveyor, who should take into account the safety arrangements provided, including weather forecasting and ship response under foreseeable conditions and provided the expected rise of water within the tank does not exceed 0.25 m.

5.5.4 When rafts or boats will be used for close-up survey, the following conditions should be observed:

- .1 only rough duty, inflatable rafts or boats, having satisfactory residual buoyancy and stability even if one chamber is ruptured, should be used;
- .2 the boat or raft should be tethered to the access ladder and an additional person should be stationed down the access ladder with a clear view of the boat or raft;
- .3 appropriate lifejackets should be available for all participants;
- .4 the surface of water in the tank or hold should be calm (under all foreseeable conditions the expected rise of water within the tank should not exceed 0.25 m) and the water level stationary. On no account should the level of the water be rising while the boat or raft is in use;

- .5 the tank, hold or space should contain clean ballast water only. Even a thin sheen of oil on the water is not acceptable; and
- .6 at no time should the water level be allowed to be within 1 m of the deepest under deck web face flat so that the survey team is not isolated from a direct escape route to the tank hatch. Filling to levels above the deck transverses should only be contemplated if a deck access manhole is fitted and open in the bay being examined, so that an escape route for the survey party is available at all times. Other effective means of escape to the deck may be considered.

5.5.5 Rafts or boats alone may be allowed for inspection of the under deck areas for tanks or spaces, if the depth of the webs is 1.5 m or less.

5.5.6 If the depth of the webs is more than 1.5 m, rafts or boats alone may be allowed only:

- .1 when the coating of the under deck structure is in GOOD condition and there is no evidence of wastage; or
- .2 if a permanent means of access is provided in each bay to allow safe entry and exit. This means:
 - .1 access direct from the deck via a vertical ladder and a small platform fitted approximately 2 m below the deck in each bay; or
 - .2 access to deck from a longitudinal permanent platform having ladders to deck in each end of the tank. The platform should, for the full length of the tank, be arranged in level with, or above, the maximum water level needed for rafting of under deck structure. For this purpose, the ullage corresponding to the maximum water level should be assumed not more than 3 m from the deck plate measured at the midspan of deck transverses and in the middle length of the tank.

If neither of the above conditions are met, then staging or other equivalent means should be provided for the survey of the under-deck areas.

5.5.7 The use of rafts or boats alone in 5.5.5 and 5.5.6 does not preclude the use of boats or rafts to move about within a tank during a survey.

5.6 *Survey planning meeting*

5.6.1 The establishment of proper preparation and the close cooperation between the attending surveyor(s) and the owner's representatives on board prior to and during the survey are an essential part in the safe and efficient conduct of the survey. During the survey on board safety meetings should be held regularly.

5.6.2 Prior to commencement of any part of the renewal and intermediate survey, a survey planning meeting should be held between the attending surveyor(s), the owner's representative in attendance, the thickness measurement Company operator (as applicable) and the master of the ship or an appropriately qualified representative appointed by the master or Company for the purpose to ascertain that all the arrangements envisaged in the survey programme are in place, so as to ensure the safe and efficient conduct of the survey work to be carried out (see also 7.1.2).

- 5.6.3 The following is an indicative list of items that should be addressed in the meeting:
- .1 schedule of the ship (i.e. the voyage, docking and undocking manoeuvres, periods alongside, cargo and ballast operations, etc.);
 - .2 provisions and arrangements for thickness measurements (i.e. access, cleaning/descaling, illumination, ventilation, personal safety);
 - .3 extent of the thickness measurements;
 - .4 acceptance criteria (refer to the list of minimum thicknesses);
 - .5 extent of close-up survey and thickness measurement considering the coating condition and suspect areas/areas of substantial corrosion;
 - .6 execution of thickness measurements;
 - .7 taking representative readings in general and where uneven corrosion/pitting is found;
 - .8 mapping of areas of substantial corrosion; and
 - .9 communication between attending surveyor(s) the thickness measurement company operator(s) and owner's representative(s) concerning findings.

6 Documentation on board

6.1 *General*

6.1.1 The owner should obtain, supply and maintain on board documentation as specified in 6.2 and 6.3, which should be readily available for the surveyor. The condition evaluation report referred to in 6.2 should include a translation into English.

6.1.2 The documentation should be kept on board for the lifetime of the ship.

6.2 *Survey report file*

6.2.1 A survey report file should be a part of the documentation on board consisting of:

- .1 reports of structural surveys (annex 6);
- .2 condition evaluation report (annex 7); and
- .3 thickness measurement reports (annex 8).

6.2.2 The survey report file should be available also in the owner's and the Administration offices or in the office of the organization recognized by the Administration.

6.3 *Supporting documents*

6.3.1 The following additional documentation should be available on board:

- .1 survey programme, as required under 5.1 until such time as the renewal survey or intermediate survey, as applicable, has been completed;

- .2 main structural plans of cargo holds and ballast tanks;
- .3 previous repair history;
- .4 cargo and ballast history;
- .5 inspections by ship's personnel with reference to:
 - .1 structural deterioration in general;
 - .2 leakages in bulkheads and piping; and
 - .3 condition of coating or corrosion prevention system, if any. Guidance for reporting is shown in annex 3; and
- .6 any other information that would help to identify critical structural areas and/or suspect areas requiring inspection.

6.4 *Review of documentation on board*

Prior to survey, the surveyor should examine the completeness of the documentation on board, and its contents as a basis for the survey.

7 Procedures for thickness measurements

7.1 *General*

7.1.1 The required thickness measurements, if not carried out by the recognized organization acting on behalf of the Administration itself, should be witnessed by a surveyor of the recognized organization. The surveyor should be on board to the extent necessary to control the process.

7.1.2 The thickness measurement company should be part of the survey planning meeting to be held prior to commencing the survey.

7.1.3 Thickness measurements of structures in areas where close-up surveys are required should be carried out simultaneously with close-up surveys.

7.1.4 In all cases the extent of the thickness measurements should be sufficient as to represent the actual average condition.

7.1.5 Procedural requirements for thickness measurements are set out in annex 12.

7.2 *Certification of thickness measurement company*

The thickness measurements should be carried out by a qualified company certified by an organization recognized by the Administration according to principles stated in annex 5.

7.3 *Reporting*

7.3.1 A thickness measurement report should be prepared and submitted to the Administration. The report should give the location of measurements, the thickness measured as well as corresponding original thickness. Furthermore, the report should give the date when the measurements were carried out, type of measuring equipment, names of

personnel and their qualifications and be signed by the operator. The thickness measurement report should follow the principles as specified in the recommended procedures for thickness measurements set out in annex 8.

7.3.2 The surveyor should review the final thickness measurement reports and countersign the cover page.

8 Reporting and evaluation of survey

8.1 *Evaluation of survey report*

8.1.1 The data and information on the structural condition of the ship collected during the survey should be evaluated for acceptability and continued structural integrity of the ship.

8.1.2 The analysis of data should be carried out and endorsed by the Administration or recognized organization authorized by the Administration and the conclusions of the analysis should form a part of the condition evaluation report.

8.2 *Reporting*

8.2.1 Principles for survey reporting are shown in annex 6.

8.2.2 When a survey is split between different survey stations, a report should be made for each portion of the survey. A list of items examined and/or tested (pressure testing, thickness measurements, etc.) and an indication of whether the item has been credited, should be made available to the next attending surveyor(s), prior to continuing or completing the survey.

8.2.3 A condition evaluation report of the survey and results should be issued to the owner as shown in annex 7 and placed on board the ship for reference at future surveys. The condition evaluation report should be endorsed by the Administration or by the recognized organization on behalf of the Administration.

ANNEX 1

REQUIREMENTS FOR CLOSE-UP SURVEY AT RENEWAL SURVEYS

Appendix 1 – Minimum requirements for close-up survey at renewal survey of double-side skin bulk carriers excluding ore carriers

Age ≤ 5 years Renewal Survey No. 1	5 < Age ≤ 10 years Renewal Survey No. 2	10 < Age ≤ 15 years Renewal Survey No. 3	Age > 15 years Renewal Survey No. 4 and subsequent
<p>One transverse web with associated plating and longitudinals in two representative water ballast tanks of each type. This is to include the foremost topside and double-side water ballast tanks on either side. (A) Two selected cargo hold transverse bulkheads, including internal structure of upper and lower stools, where fitted. (C) All cargo hold hatch covers and coaming (plating and stiffeners). (D)</p>	<p>One transverse web with associated plating and longitudinals as applicable in each water ballast tank. (A) Forward and aft transverse bulkheads including stiffening system in a transverse section including topside, hopper side and double-side ballast tanks. (A) 25% of ordinary transverse web frames in the foremost double-side tanks. (B) One transverse bulkhead in each cargo hold, including internal structure of upper and lower stools, where fitted. (C) All cargo hold hatch covers and coamings (plating and stiffeners). (D) All deck plating and under-deck structure inside line of hatch openings between all cargo hold hatches. (E)</p>	<p>All transverse webs with associated plating and longitudinals as applicable in each water ballast tank. (A) All transverse bulkheads including stiffening system in each water ballast tank. (A) 25% of ordinary transverse web frames in all double-side tanks. (B) All cargo hold transverse bulkheads including internal structure of upper and lower stools, where fitted. (C) All cargo hold hatch covers and coamings (plating and stiffeners). (D) All deck plating and under-deck structure inside line of hatch openings between all cargo hold hatches. (E)</p>	<p>All transverse webs with associated plating and longitudinals as applicable in each water ballast tank. (A) All transverse bulkheads including stiffening system in each water ballast tank. (A) All ordinary transverse frames in all double-side tanks. (B) Areas (C)–(E) as for column 3</p>

(A), (B), (C), (D) and (E) are areas to be subjected to close-up surveys and thickness measurements (see sketches in appendix 3 to annex 8)

- (A) Transverse web frame or watertight transverse bulkhead in topside, hopper side and double-side ballast tanks. In fore and aft peak tanks transverse web frame means a complete transverse web frame ring including adjacent structural members.
- (B) Ordinary transverse frame in double-side tanks.
- (C) Cargo hold transverse bulkhead, plating, stiffeners and girders.
- (D) Cargo hold hatch covers and coamings.
- (E) Deck plating and under-deck structure inside line of hatch openings between cargo hold hatches.

Note: Close-up survey of transverse bulkheads should be carried out at four levels:

- Level (a) Immediately above the inner bottom and immediately above the line of gussets (if fitted) and shedders for ships without lower stool.
- Level (b) Immediately above and below the lower stool shelf plate (for those ships fitted with lower stools), and immediately above the line of the shedder plates.
- Level (c) About mid-height of the bulkhead.
- Level (d) Immediately below the upper deck plating and immediately adjacent to the upper wing tank, and immediately below the upper stool shelf plate for those ships fitted with upper stools, or immediately below the topside tanks.

Appendix 2

Minimum requirements for close-up survey at renewal survey for ore carriers

Age < 5 years	5 < Age ≤ 10 years	age > 10
Renewal Survey No.1	Renewal Survey No.2	Renewal Survey No.3 and subsequent
<p>One web frame ring complete including adjacent structural members in a ballast wing tank. (A)</p> <p>One transverse bulkhead lower part – including girder system and adjacent structural members – in a ballast tank. (A)</p>	<p>All web frame rings complete including adjacent structural members in a ballast wing tank. (A)</p> <p>One deck transverse including adjacent deck structural members in each remaining ballast tank. (A)</p> <p>Forward and aft transverse bulkheads complete – including girder system and adjacent structural members – in a ballast wing tank.</p> <p>One transverse bulkhead lower part – including girder system and adjacent structural members – in each remaining ballast tank. (A)</p>	<p>All web frame rings complete including adjacent structural members in each ballast tank. (A)</p> <p>All transverse bulkheads complete – including girder system and adjacent structural members – in each ballast tank. (A)</p> <p>One web frame ring complete including adjacent structural members in each wing void space. (A)</p> <p>Additional web frame rings in void spaces as deemed necessary by the Administration or organization recognized by the Administration. (A)</p>
Two selected cargo hold transverse bulkheads, including internal structure of upper and lower stools, where fitted. (C)	One transverse bulkhead in each cargo hold, including internal structure of upper and lower stools, where fitted. (C)	All cargo hold transverse bulkheads, including internal structure of upper and lower stools, where fitted. (C)
All cargo hold hatch covers and coamings (plating and stiffeners). (D)	All cargo hold hatch covers and coamings (plating and stiffeners). (D)	All cargo hold hatch covers and coamings (plating and stiffeners). (D)
	All deck plating and under deck structure inside line of hatch openings between all cargo hold hatches. (E)	All deck plating and under deck structure inside line of hatch openings between all cargo hold hatches. (E)

(A), (C), (D) and (E) are areas to be subjected to close-up surveys and thickness measurements (see sketches in appendix 3 to annex 8)

- (A) Transverse web frame or watertight transverse bulkhead in ballast wing tanks and void spaces. In fore and aft peak tanks transverse web frame means a complete transverse web frame ring including adjacent structural members.
- (C) Cargo hold transverse bulkhead plating, stiffeners and girders.
- (D) Cargo hold hatch covers and coamings.
- (E) Deck plating and under deck structure inside line of hatch openings between cargo hold hatches.

Note: Close-up survey of transverse bulkheads should be carried out at four levels:

- Level (a) Immediately above the inner bottom and immediately above the line of gussets (if fitted) and shedders for ships without lower stool.
- Level (b) Immediately above and below the lower stool shelf plate (for those ships fitted with lower stools), and immediately above the line of the shedder plates.
- Level (c) About mid-height of the bulkhead.
- Level (d) Immediately below the upper deck plating and immediately adjacent to the upper wing tank, and immediately below the upper stool shelf plate for those ships fitted with upper stools, or immediately below the topside tanks.

ANNEX 2

REQUIREMENTS FOR THICKNESS MEASUREMENTS AT RENEWAL SURVEYS

Age ≤ 5 years Renewal Survey No. 1	5 < Age ≤ 10 years Renewal Survey No. 2	10 < Age ≤ 15 years Renewal Survey No. 3	Age > 15 years Renewal Survey No. 4 and subsequent
1 Suspect areas	1 Suspect areas 2 Within the cargo length area: two transverse sections of deck plating outside line of cargo hatch openings 3 Measurement, for general assessment and recording of corrosion pattern, of those structural members subject to close-up survey according to annex 1 4 Wind and water strakes in way of the two transverse sections considered under point 2 above 5 Selected wind and water strakes outside the cargo length area	1 Suspect areas 2 Within the cargo length area: .1 each deck plate outside line of cargo hatch openings .2 two transverse sections, one of which should be in the amidship area, outside line of cargo hatch openings 3 Measurement, for general assessment and recording of corrosion pattern, of those structural members subject to close-up survey according to annex 1 4 All wind and water strakes within the cargo length area 5 Selected wind and water strakes outside the cargo length area	1 Suspect areas 2 Within the cargo length area: .1 each deck plate outside line of cargo hatch openings .2 three transverse sections, one of which should be in the amidship area, outside line of cargo hatch openings .3 each bottom plate 3 Point 3 referred to in column 3 4 All wind and water strakes, full length

ANNEX 3

OWNER'S INSPECTION REPORT

Structural condition

Ship's name:							
Owner's inspection report – Structural condition							
For tank/hold No:.....							
Grade of steel: deck: side:							
bottom: longitudinal bulkhead:							
Elements	Cracks	Buckles	Corrosion	Coating	Pitting	Modification/repair	Other
	condition						
Deck:							
Bottom:							
Side:							
Side framing:							
Longitudinal bulkheads:							
Transverse bulkheads:							
Repairs carried out due to:							
Thickness measurements carried out (dates):							
Results in general:							
Overdue surveys:							
Outstanding conditions of class:							
Comments:							
Date of inspection:							
Inspected by:							
Signature:							

ANNEX 4A

SURVEY PROGRAMME**Basic information and particulars**

Name of ship:
IMO number:
Flag State:
Port of registry:
Gross tonnage:
Deadweight (metric tonnes):
Length between perpendiculars (m):
Shipbuilder:
Hull number:
Recognized organization (RO):
RO ship identity:
Date of build of the ship:
Owner:
Thickness measurement company:

1 Preamble1.1 *Scope*

1.1.1 The present survey programme covers the minimum extent of overall surveys, close-up surveys, thickness measurements and pressure testing within the cargo length area, cargo holds, ballast tanks, including fore and aft peak tanks, required by the Code.

1.1.2 The arrangements and safety aspects of the survey should be acceptable to the attending surveyor(s).

1.2 *Documentation*

All documents used in the development of the survey programme should be available on board during the survey as required by section 6.

2 Arrangement of cargo holds, tanks and spaces

This section of the survey programme should provide information (either in the form of plans or text) on the arrangement of cargo holds, tanks and spaces that fall within the scope of the survey.

3 List of cargo holds, tanks and spaces with information on their use, extent of coatings and corrosion prevention system

This section of the survey programme should indicate any changes relating to (and should update) the information on the use of the holds and tanks of the ship, the extent of coatings and the corrosion prevention system provided in the survey planning questionnaire.

4 Conditions for survey

This section of the survey programme should provide information on the conditions for survey, e.g. information regarding cargo hold and tank cleaning, gas freeing, ventilation, lighting, etc.

5 Provisions and method of access to structures

This section of the survey programme should indicate any changes relating to (and should update) the information on the provisions and methods of access to structures provided in the survey planning questionnaire.

6 List of equipment for survey

This section of the survey programme should identify and list the equipment that will be made available for carrying out the survey and the required thickness measurements.

7 Survey requirements

7.1 Overall survey

This section of the survey programme should identify and list the spaces that should undergo an overall survey for this ship in accordance with 2.5.1.

7.2 Close-up survey

This section of the survey programme should identify and list the hull structures that should undergo a close-up survey for this ship in accordance with 2.5.2.

8 Identification of tanks for tank testing

This section of the survey programme should identify and list the cargo holds and tanks that should undergo tank testing for this ship in accordance with 2.7.

9 Identification of areas and sections for thickness measurements

This section of the survey programme should identify and list the areas and sections where thickness measurements should be taken in accordance with 2.6.1.

10 Minimum thickness of hull structures

This section of the survey programme should specify the minimum thickness for hull structures of this ship that are subject to survey, according to .1 or .2:

- .1 Determined from the attached wastage allowance table and the original thickness to the hull structure plans of the ship;
- .2 Given in the following table(s):

Area or location	Original as-built thickness (mm)	Minimum thickness (mm)	Substantial corrosion thickness (mm)
Deck			
Plating			
Longitudinals			
Longitudinal girders			
Cross deck plating			
Cross deck stiffeners			
Bottom			
Plating			
Longitudinals			
Longitudinal girders			
Inner bottom			
Plating			
Longitudinals			
Longitudinal girders			
Floors			
Ship side in way of topside tanks			
Plating			
Longitudinals			
Ship side in way of hopper side tanks			
Plating			
Longitudinals			
Ship side in way of double-hull tanks (if applicable)			
Plating			
Longitudinals or ordinary transverse frames			
Longitudinal stringers			
Longitudinal bulkhead inner side (if applicable)			
Plating			
Longitudinals (if applicable)			
Longitudinals or ordinary transverse frames			
Longitudinal girders (if applicable)			
Transverse bulkheads			
Plating			
Stiffeners (if applicable)			
Upper stool plating			
Upper stool stiffeners			
Lower stool plating			
Lower stool stiffeners			
Transverse web frames in topside tanks			
Plating			
Flanges			
Stiffeners			

Area or location	Original as-built thickness (mm)	Minimum thickness (mm)	Substantial corrosion thickness (mm)
Transverse web frames in hopper tanks			
Plating			
Flanges			
Stiffeners			
Transverse web frames in double-side tanks			
Plating			
Flanges			
Stiffeners			
Hatch covers			
Plating			
Stiffeners			
Hatch coamings			
Plating			
Stiffeners			

Note: The wastage allowance tables should be attached to the survey programme.

11 Thickness measurement company

This section of the survey programme should identify changes, if any, relating to the information on the thickness measurement company provided in the survey planning questionnaire.

12 Damage experience related to the ship

This section of the survey programme should, using the tables provided below, provide details of the hull damages for at least the last three years in way of the cargo holds, ballast tanks and void spaces within the cargo length area. These damages are subject to survey.

Hull damages sorted by location for this ship

Cargo hold, tank or space number or area	Possible cause, if known	Description of the damages	Location	Repair	Date of repair

Hull damages for sister or similar ships (if available) in the case of design-related damage

Cargo hold, tank or space number or area	Possible cause, if known	Description of the damages	Location	Repair	Date of repair

13 Areas identified with substantial corrosion from previous surveys

This section of the survey programme should identify and list the areas of substantial corrosion from previous surveys.

14 Critical structural areas and suspect areas

This section of the survey programme should identify and list the critical structural areas and the suspect areas, when such information is available.

15 Other relevant comments and information

This section of the survey programme should provide any other comments and information relevant to the survey.

Appendices

Appendix 1 – List of plans

The provisions of 5.1.3.2 require that the main structural plans of cargo holds and ballast tanks (scantling drawings), including information regarding the use of high-tensile steel (HTS), should be available. This appendix of the survey programme should identify and list the main structural plans which form part of the survey programme.

Appendix 2 – Survey planning questionnaire

The survey planning questionnaire (annex 4B), which has been submitted by the owner, should be appended to the survey programme.

Appendix 3 – Other documentation

This part of the survey programme should identify and list any other documentation that forms part of the plan.

Prepared by the owner in cooperation with the Administration for compliance with 5.1.3.

Date:

(name and signature of authorized owner's representative)

Date:

(name and signature of authorized representative of the Administration)

ANNEX 4B

SURVEY PLANNING QUESTIONNAIRE

1 The following information will enable the owner, in cooperation with the Administration, to develop a survey programme complying with the requirements of the Code. It is essential that the owner provides, when completing the present questionnaire, up-to-date information. The present questionnaire, when completed, should provide all information and material required by the Code.

Particulars

Ship's name:

IMO number:

Flag State:

Port of registry:

Owner:

Recognized organization:

RO Ship identity:

Gross tonnage:

Deadweight (metric tonnes):

Date of build:

Information on access provision for close-up surveys and thickness measurement

2 The owner should indicate, in the table below, the means of access to the structures subject to close-up survey and thickness measurement. A close-up survey is an examination where the details of structural components are within the close visual inspection range of the attending surveyor, i.e. normally within reach of hand.

Hold/Tank No.	Structure	Temporary staging	Rafts	Ladders	Direct access	Other means (please specify)
F.P.	Fore peak					
A.P.	Aft peak					
Cargo holds	Hatch side coamings					
	Topside sloping plate					
	Upper stool plating					
	Cross deck					
	Double-side tank plating					
	Transverse bulkhead					
	Hopper tank plating					
	Lower stool plating					
Topside tanks	Tank top					
	Under-deck structure					
	Side shell and structure					
	Sloping plate and structure					
Hopper tanks	Webs and bulkheads					
	Hopper sloping plate and structure					
	Side shell and structure					
	Bottom structure					
Double-side tanks	Webs and bulkheads					
	Side shell and structure					
	Inner skin and structure					
	Double-bottom structure					
	Upper stool internal structure					
	Lower stool internal structure					

Hold/Tank No.	Structure	Temporary staging	Rafts	Ladders	Direct access	Other means (please specify)
Wing tanks of ore carriers	Underdeck and structure					
	Side shell and structure					
	Side shell vertical web and structure					
	Longitudinal bulkhead and structure					
	Longitudinal bulkhead web and structure					
	Bottom plating and structure					
	Cross ties/stringers					

History of bulk cargoes of a corrosive nature (e.g. high-sulphur content)

Owner's inspections

3 Using a format similar to that of the table below (which is given as an example), the owner should provide details of the results of their inspections, for the last three years in accordance with the Code on all CARGO holds and BALLAST tanks and VOID spaces within the cargo area.

Tank/Hold No.	Corrosion protection (1)	Coating extent (2)	Coating condition (3)	Structural deterioration (4)	Hold and tank history (5)
Cargo holds					
Topside tanks					
Hopper tanks					
Double-side skin tanks					
Double-bottom tanks					
Upper stools					
Lower stools					
Wing tanks (ore tankers)					
Fore peak					
Aft peak					
Miscellaneous other spaces:					

Note:

Indicate tanks which are used for oil/ballast.

- 1) HC = hard coating; SC = soft coating;
SH = semi-hard coating; NP = no protection
- 2) U = upper part; M = middle part;
L = lower part; C = complete
- 3) G = good; F = fair; P = poor;
RC = recoated (during the last three years)
- 4) N = no findings recorded; Y = findings recorded,
description of findings should be attached to this questionnaire
- 5) DR = damage & repair; L = leakages;
CV = conversion (description to be attached to this questionnaire)

Name of owner's representative: Signature:..... Date:
--

Reports of port State control inspections

List the reports of port State control inspections containing hull structural related deficiencies, and relevant information on rectification of the deficiencies:

Safety management system

List non-conformities related to hull maintenance, including the associated corrective actions:

Name and address of the approved thickness measurement company

ANNEX 5

PROCEDURES FOR CERTIFICATION OF A COMPANY ENGAGED IN THICKNESS MEASUREMENT OF HULL STRUCTURES

1 Application

This guidance applies for certification of the company which intends to engage in the thickness measurement of hull structures of ships.

2 Procedures for certification

Submission of documents

2.1 The following documents should be submitted to an organization recognized by the Administration for approval:

- .1 outline of the company, e.g. organization and management structure;
- .2 experience of the company on thickness measurement of hull structures of ships;
- .3 technicians' careers, i.e. experience of technicians as thickness measurement operators, technical knowledge and experience of hull structure, etc. Operators should be qualified according to a recognized industrial NDT Standard;
- .4 equipment used for thickness measurement such as ultrasonic testing machines and their maintenance/calibration procedures;
- .5 a guide for thickness measurement operators;
- .6 training programmes for technicians for thickness measurement;
- .7 measurement record format in accordance with recommended procedures for thickness measurements (see annex 8).

Auditing of the company

2.2 Upon reviewing the documents submitted with satisfactory results, the company should be audited in order to ascertain that the company is duly organized and managed in accordance with the documents submitted, and eventually is capable of conducting thickness measurement of the hull structure of ships.

2.3 Certification is conditional upon an on board demonstration of thickness measurement as well as satisfactory reporting.

3 Certification

3.1 Upon satisfactory results of both the audit of the company referred to in 2.2 and the demonstration tests referred to in 2.3, the Administration or organization recognized by the Administration should issue a certificate of approval as well as a notice to the effect that the thickness measurement operation system of the company has been certified.

3.2 Renewal/endorsement of the certificate should be made at intervals not exceeding three years by verification that original conditions are maintained.

4 Report of any alteration to the certified thickness measurement operation system

In cases where any alteration to the certified thickness measurement operation system of the company is made, such an alteration should be immediately reported to the organization recognized by the Administration. Re-audit should be made where deemed necessary by the organization recognized by the Administration.

5 Withdrawal of the certification

The certification may be withdrawn in the following cases:

- .1 where the measurements were improperly carried out or the results were improperly reported;
- .2 where the surveyor found any deficiencies in the approved thickness measurement operation systems of the company; and
- .3 where the company failed to report any alteration referred to in 4 to the organization recognized by the Administration as required.

ANNEX 6

SURVEY REPORTING PRINCIPLES

As a principle, for bulk carriers subject to the Code, the surveyor should include the following contents in his report for survey of hull structure and piping systems, as relevant for the survey.

1 General

1.1 A survey report should be generated in the following cases:

- .1 in connection with commencement, continuation and/or completion of periodical hull surveys, i.e. annual, intermediate and renewal surveys, as relevant;
- .2 when structural damages/defects have been found;
- .3 when repairs, renewals or modifications have been carried out; and
- .4 when condition of class (recommendation) has been imposed or has been deleted.

1.2 The reporting should provide:

- .1 evidence that prescribed surveys have been carried out in accordance with applicable requirements;
- .2 documentation of surveys carried out with findings, repairs carried out and condition of class (recommendation) imposed or deleted;
- .3 survey records, including actions taken, which should form an auditable documentary trail. Survey reports should be kept in the survey report file required to be on board;
- .4 information for planning of future surveys; and
- .5 information which may be used as input for maintenance of classification rules and instructions.

1.3 When a survey is split between different survey stations, a report should be made for each portion of the survey. A list of items surveyed, relevant findings and an indication of whether the item has been credited, should be made available to the next attending surveyor, prior to continuing or completing the survey. Thickness measurement and tank testing carried out should also be listed for the next surveyor.

2 Extent of the survey

2.1 Identification of compartments where an overall survey has been carried out.

2.2 Identification of locations, in each ballast tank and cargo hold including hatch covers and coamings, where a close-up survey has been carried out, together with information on the means of access used.

2.3 Identification of locations, in each ballast tank and cargo hold including hatch covers and coamings, where thickness measurement has been carried out.

Note: As a minimum, the identification of location of close-up survey and thickness measurement should include a confirmation with description of individual structural members corresponding to the extent of requirements stipulated in part B of annex A based on type of periodical survey and the ship's age.

Where only partial survey is required, e.g. one transverse web, two selected cargo hold transverse bulkheads, the identification should include location within each ballast tank and cargo hold by reference to frame numbers.

2.4 For areas in ballast tanks and cargo holds where protective coating is found to be in good condition and the extent of close-up survey and/or thickness measurement has been specially considered, structures subject to special consideration should be identified.

2.5 Identification of tanks subject to tank testing.

2.6 Identification of piping systems on deck and within cargo holds, ballast tanks, pipe tunnels, cofferdams and void spaces where:

- .1 examination including internal examination of piping with valves and fittings and thickness measurement, as relevant, has been carried out; and
- .2 operational test to working pressure has been carried out.

3 Result of the survey

3.1 Type, extent and condition of protective coating in each tank, as relevant (rated GOOD, FAIR or POOR).

3.2 Structural condition of each compartment with information on the following, as relevant:

- .1 identification of findings, such as:
 - .1 corrosion with description of location, type and extent;
 - .2 areas with substantial corrosion;
 - .3 cracks/fractures with description of location and extent;
 - .4 buckling with description of location and extent; and
 - .5 indents with description of location and extent;
- .2 identification of compartments where no structural damages/defects are found. The report may be supplemented by sketches/photos; and
- .3 thickness measurement report should be verified and signed by the surveyor controlling the measurements on board.

4 Actions taken with respect to findings

4.1 Whenever the attending surveyor is of the opinion that repairs are required, each item to be repaired should be identified in a numbered list. Whenever repairs are carried out, details of the repairs effected should be reported by making specific reference to relevant items in the numbered list.

4.2 Repairs carried out should be reported with identification of:

- .1 compartment;
- .2 structural member;
- .3 repair method (i.e. renewal or modification), including:
 - .1 steel grades and scantlings (if different from the original); and
 - .2 sketches/photos, as appropriate;
- .4 repair extent; and
- .5 non-destructive test (NDT)/tests.

4.3 For repairs not completed at the time of survey, condition of class/recommendation should be imposed with a specific time limit for the repairs. In order to provide correct and proper information to the surveyor attending for survey of the repairs, condition of class/recommendation should be sufficiently detailed with identification of each item to be repaired. For identification of extensive repairs, reference may be made to the survey report.

ANNEX 7

CONDITION EVALUATION REPORT

Issued upon completion of renewal survey

General particulars

Ship's name:	Class/Administration identity number: Previous class/Administration identity number(s): IMO number:
Port of registry:	National flag: Previous national flag(s):
Deadweight (metric tonnes):	Gross tonnage: National: ITC (1969):
Date of build:	Classification notation:
Date of major conversion:	
Type of conversion:	Owner: Previous owner(s):

1 The survey reports and documents listed below have been reviewed by the undersigned and found to be satisfactory.

2 A summary of the survey is attached herewith on sheet 2.

3 The renewal survey has been completed in accordance with the present Code on (date)

Condition evaluation report completed by	Name Signature	Title
Office	Date	
Condition evaluation report verified by	Name Signature	Title
Office	Date	

Attached reports and documents:

- 1)
- 2)
- 3)
- 4)
- 5)
- 6)

Contents of condition evaluation report

Part 1	– General particulars:	- See front page
Part 2	– Report review:	- Where and how survey was done
Part 3	– Close-up survey:	- Extent (which tanks/holds)
Part 4	– Thickness measurements:	- Reference to thickness measurement report - Summary of where measured - Separate form indicating the spaces with substantial corrosion, and corresponding: - thickness diminution - corrosion pattern
Part 5	– Tank/hold corrosion prevention system:	- Separate form indicating: - location of coating - condition of coating (if applicable)
Part 6	– Repairs:	- Identification of spaces/areas
Part 7	– Condition of class/flag State requirements:	
Part 8	– Memoranda:	- Acceptable defects - Any points of attention for future surveys, e.g. for suspect areas - Extended annual/intermediate survey due to coating breakdown
Part 9	– Conclusion:	- Statement on evaluation/verification of survey report

Extract of thickness measurements

Reference is made to the thickness measurement report:

Position of substantially corroded tanks/areas¹ or areas with deep pitting³	Thickness diminution [%]	Corrosion pattern²	Remarks: (e.g. reference to attached sketches)

Notes:

- 1 Substantial corrosion, i.e. 75 to 100 per cent of acceptable margins wasted.
- 2 P = Pitting
C = Corrosion in general
- 3 Any bottom plating with a pitting intensity of 20 per cent or more, with wastage in the substantial corrosion range or having an average depth of pitting of $\frac{1}{3}$ or more of actual plate thickness should be noted.

Tank/hold corrosion prevention system

Tank/hold Nos. ¹	Tank/hold corrosion prevention system ²	Coating condition ³	Remarks

Notes:

- 1 All ballast tanks and cargo holds should be listed.
 2 C = Coating NP = No protection
 3 Coating condition according to the following standard:

GOOD condition with only minor spot rusting.

FAIR condition with local breakdown of coating at edges of stiffeners and weld connections and/or light rusting over 20 per cent or more of areas under consideration, but less than as defined for POOR condition.

POOR condition with general breakdown of coating over 20 per cent or more of areas or hard scale at 10 per cent or more of areas under consideration.

If coating condition POOR is given, extended annual surveys should be introduced. This should be noted in part 8 of the contents of condition evaluation report.

ANNEX 8

RECOMMENDED PROCEDURES FOR THICKNESS MEASUREMENTS

- 1 This annex should be used for recording thickness measurements as required by part B of annex A.
- 2 Thickness measurement sheet forms TM1-DSBC, TM2-DSBC(i), TM2-DSBC(ii), TM3-DSBC, TM4-DSBC, TM5-DSBC and TM6-DSBC (appendix 2) should be used, as appropriate, for recording thickness measurements. The maximum allowable diminution should be stated. The maximum allowable diminution could be stated in an attached document.
- 3 Appendix 3 contains guidance diagrams and notes relating to the reporting forms and the procedure for the thickness measurements.

Appendix 1
THICKNESS MEASUREMENT REPORT GENERAL PARTICULARS

Ship's name:
 IMO number:
 Class/Administration identity number:
 Port of registry:
 Gross tonnage:
 Deadweight:
 Date of build:
 Classification society:

Name of company performing thickness measurement:
 Thickness measurement company certified by:
 Certificate number:
 Certificate valid from: to
 Place of measurement:
 First date of measurement:
 Last date of measurement:
 Renewal survey/intermediate survey* due:
 Details of measurement equipment:
 Qualification of operator:

Report number:	consisting of	pages
Name of operator:	Name of surveyor:	
Signature of operator:	Signature of surveyor:	
Company official stamp:	Administration:	

Official stamp

* Delete as appropriate.

Appendix 2

Report on thickness measurement of all deck plating, bottom shell plating and side shell plating* (TM1-DSBC)

Ship's name..... Class Identity No..... Report No..... IMO number.....

STRAKE POSITION																		
	PLATE POSITION	No. or letter	Orig. thk. (mm)	Forward reading						Aft reading						Mean diminution %		
				Gauged		Diminution P		Diminution S		Gauged		Diminution P		Diminution S		P	S	mm
				P	S	mm	%	mm	%	P	S	mm	%	mm	%			
12th forward																		
11th																		
10th																		
9th																		
8th																		
7th																		
6th																		
5th																		
4th																		
3rd																		
2nd																		
1st																		
Amidships																		
1st aft																		
2nd																		
3rd																		
4th																		
5th																		
6th																		
7th																		
8th																		
9th																		
10th																		
11th																		
12th																		

Operator's signature.....

Notes – see following page

* Delete as appropriate.

Notes to report TM1-DSBC:

- 1 This report should be used for recording the thickness measurement of:
 - .1 all strength deck plating within cargo length area;
 - .2 all keel, bottom shell plating and bilge plating within the cargo length area;
 - .3 side shell plating including selected wind and water strakes outside cargo length area; and
 - .4 all wind and water strakes within cargo length area.
- 2 The strake position should be cleared as follows:
 - .1 for strength deck indicate the number of the strake of plating inboard from the stringer plate;
 - .2 for bottom plating indicate the number of the strake of plating outboard from the keel plate; and
 - .3 for side shell plating give number of the strake of plating below sheerstrake and letter as shown on shell expansion.
- 3 Only the deck plating strakes outside line of openings are to be recorded.
- 4 Measurements should be taken at the forward and aft areas of all plates and where plates cross ballast/cargo tank boundaries separate measurements for the area of plating in way of each type of tank should be recorded.
- 5 The single measurements recorded should represent the average of multiple measurements.
- 6 The maximum allowable diminution could be stated in an attached document.

**Report on thickness measurement of shell and deck plating at transverse sections (one, two or three transverse sections)
(TM2-DSBC(i))**

Ship's name..... Class Identity No..... Report No..... IMO number.....

STRENGTH DECK AND SHEERSTRAKE PLATING																											
STRAKE POSITION	FIRST TRANSVERSE SECTION AT FRAME NUMBER....								SECOND TRANSVERSE SECTION AT FRAME NUMBER....								THIRD TRANSVERSE SECTION AT FRAME NUMBER....										
	No. or letter	Orig. thk	Max allow. dimin.	Gauged		Diminution P		Diminution S		No. or letter	Orig. thk	Max allow. dimin.	Gauged		Diminution P		Diminution S		No. or letter	Orig. thk	Max allow. dimin.	Gauged		Diminution P		Diminution S	
		(mm)	(mm)	P	S	mm	%	mm	%		(mm)	(mm)	P	S	mm	%	mm	%		(mm)	(mm)	P	S	mm	%	mm	%
Stringer plate																											
1st strake inboard																											
2nd																											
3rd																											
4th																											
5th																											
6th																											
7th																											
8th																											
9th																											
10th																											
11th																											
12th																											
13th																											
14th																											
centre strake																											
sheerstrake																											
TOPSIDE																											
TOTAL																											

Operator's signature.....

Notes – see following page

Notes to report TM2-DSBC(i):

- 1 This report should be used for recording the thickness measurement of:

Strength deck plating and sheerstrake plating transverse sections:

One, two or three sections within the cargo length area, comprising structural items (1), (2) and (3) as shown on the diagrams of typical transverse sections (appendix 3).
- 2 Only the deck plating strakes outside line of hatch openings should be recorded.
- 3 The top side area comprises deck plating, stringer plate and sheerstrake (including rounded gunwales).
- 4 The exact frame station of measurement should be stated.
- 5 The single measurements recorded should represent the average of multiple measurements.
- 6 The maximum allowable diminution could be stated in an attached document.

**Report on thickness measurement of shell and deck plating at transverse sections (one, two or three transverse sections)
(TM2-DSBC(ii))**

Ship's name..... Class Identity No..... Report No..... IMO number.....

SHELL PLATING																											
STRAKE POSITION	FIRST TRANSVERSE SECTION AT FRAME NUMBER....								SECOND TRANSVERSE SECTION AT FRAME NUMBER....								THIRD TRANSVERSE SECTION AT FRAME NUMBER....										
	No. or letter	Orig. thk	Max allow. dimin.	Gauged		Diminution P		Diminution S		No. or letter	Orig. thk	Max allow. dimin.	Gauged		Diminution P		Diminution S		No. or letter	Orig. thk	Max allow. dimin.	Gauged		Diminution P		Diminution S	
		(mm)	(mm)	P	S	mm	%	mm	%		(mm)	(mm)	P	S	mm	%	mm	%		(mm)	(mm)	P	S	mm	%	mm	%
1st below sheerstrake																											
2nd																											
3rd																											
4th																											
5th																											
6th																											
7th																											
8th																											
9th																											
10th																											
11th																											
12th																											
13th																											
14th																											
15th																											
16th																											
17th																											
18th																											
19th																											
20th																											
keel strake																											
BOTTOM TOTAL																											

Operator's signature.....

Notes – see following page

Notes to report TM2-DSBC(ii):

- 1 This report should be used for recording the thickness measurement of:

Shell plating at transverse sections:

One, two or three sections within the cargo length area, comprising structural items (3), (4), (5) and (6) as shown on the diagrams of typical transverse sections in appendices 3 and 4.
- 2 The bottom area comprises keel, bottom and bilge plating.
- 3 The exact frame station of measurement should be stated.
- 4 The single measurements recorded should represent the average of multiple measurements.
- 5 The maximum allowable diminution could be stated in an attached document.

**Report on thickness measurement of longitudinal members at transverse sections (one, two or three transverse sections)
(TM3-DSBC)**

Ship's name..... Class Identity No..... Report No..... IMO number.....

STRUCTURAL MEMBER	FIRST TRANSVERSE SECTION AT FRAME NUMBER....								SECOND TRANSVERSE SECTION AT FRAME NUMBER....								THIRD TRANSVERSE SECTION AT FRAME NUMBER....											
	Item no.	Orig. thk	Max allow. dimin.	Gauged		Diminution P		Diminution S		Item no.	Orig. thk	Max allow. dimin.	Gauged		Diminution P		Diminution S		Item no.	Orig. thk	Max allow. dimin.	Gauged		Diminution P		Diminution S		
		(mm)	(mm)	P	S	mm	%	mm	%		(mm)	(mm)	P	S	mm	%	mm	%		(mm)	(mm)	P	S	mm	%	mm	%	

Operator's signature.....

Notes – see following page

Notes to report TM3-DSBC:

- 1 This report should be used for recording the thickness measurement of:

Longitudinal members at transverse sections:

Two, or three sections within the cargo length area comprising the appropriate structural items (10) to (25) as shown on diagrams of typical transverse sections in appendices 3 and 4.
- 2 The exact frame station of measurement should be stated.
- 3 The single measurements recorded should represent the average of multiple measurements.
- 4 The maximum allowable diminution could be stated in an attached document.

Report on thickness measurement of transverse structural members in the double-bottom, hopper side and topside water ballast tanks (TM4-DSBC)

Ship's name Class Identity No. Report No. IMO number

TANK DESCRIPTION:									
LOCATION OF STRUCTURE:									
STRUCTURAL MEMBER	ITEM	Original thickness (mm)	Max. allow. dimin. (mm)	Gauged		Diminution P		Diminution S	
				Port	Starboard	mm	%	mm	%

Operator's signature Notes – see following page

Notes to report TM4-DSBC:

- 1 This report should be used for recording the thickness measurement of:

Transverse structural members, comprising the appropriate structural items (30) to (34) as shown on diagrams of typical transverse sections illustrated in appendices 3 and 4.
- 2 Guidance for areas of measurements is indicated in appendix 5.
- 3 The single measurements recorded should represent the average of multiple measurements.
- 4 The maximum allowable diminution could be stated in an attached document.

Report on thickness measurement of watertight transverse bulkheads in cargo holds (TM5-DSBC)

Ship's name..... Class Identity No..... Report No..... IMO number.....

LOCATION OF STRUCTURE:							FRAME NO:	
STRUCTURAL COMPONENT (PLATING/STIFFENER)								
	Original thickness	Max. allow. dimin.	Gauged		Diminution P		Diminution S	
	(mm)	(mm)	P	S	mm	%	mm	%

Operator's signature.....

Notes – see following page

Notes to report TM5-DSBC:

- 1 This report should be used for recording the thickness measurement of:
Watertight transverse bulkheads in cargo holds.
- 2 Guidance for areas of measurements is indicated in appendix 3.
- 3 The single measurements recorded should represent the average of multiple measurements.
- 4 The maximum allowable diminution could be stated in an attached document.

Report on thickness measurement of miscellaneous structural members (TM6-DSBC)

Ship's name..... Class Identity No..... Report No..... IMO number.....

STRUCTURAL MEMBER:								SKETCH		
LOCATION OF STRUCTURE:										
DESCRIPTION	Orig. thk.	Max. allow. dimin.	Gauged		Diminution P		Diminution S			
	mm	mm	P	S	mm	%	mm			%

Operator's signature..... Notes – see following page

Notes to report TM6-DSBC:

- 1 This report should be used for recording the thickness measurement of:

Miscellaneous structural members including structural items (40), (41) and (42) as shown on diagrams of typical transverse sections illustrated in appendix 3.
- 2 Guidance for areas of measurements is indicated in appendix 5.
- 3 The single measurements recorded should represent the average of multiple measurements.
- 4 The maximum allowable diminution could be stated in an attached document.

Appendix 3

**THICKNESS MEASUREMENT – DOUBLE-SIDE SKIN CONSTRUCTION SHIPS
THICKNESS MEASUREMENT – DOUBLE-SIDE SKIN BULK CARRIER**

Typical transverse section of a double-side skin bulk carrier with indication of longitudinal and transverse members.

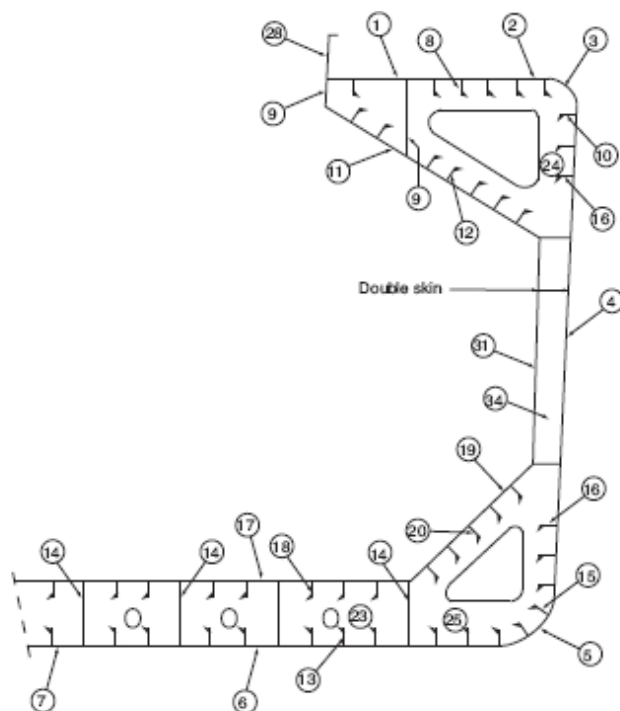

REPORT ON TM2-DSBC(i) and (ii)	
①	Strength deck plating
②	Stringer plate
③	Sheerstrake
④	Side shell plating
⑤	Bilge plating
⑥	Bottom shell plating
⑦	Keel plate

REPORT ON TM3-DSBC	
⑧	Deck longitudinal
⑨	Deck girders
⑩	Sheerstrake longitudinal
⑪	Topside tank sloping plating
⑫	Topside tank sloping plating longitudinal
⑬	Bottom longitudinal
⑭	Bottom girders
⑮	Bilge longitudinal
⑯	Side shell longitudinal, if any
⑰	Inner bottom plating
⑱	Inner bottom longitudinal
⑲	Hopper plating
⑳	Hopper longitudinal
㉑	Inner side plating – Inner side longitudinal, if any – Horizontal girders in wing ballast tanks

REPORT ON TM4-DSBC	
㉒	Double-bottom tank floors
㉓	Hopper side tank transverses
㉔	Transverse web frame – Topside tank transverses

REPORT ON TM6-DSBC	
㉕	Hatch coamings – Deck plating between hatches – Hatch covers

THICKNESS MEASUREMENT – ORE CARRIERS

Typical transverse section of an ore carrier with indication of longitudinal and transverse members.

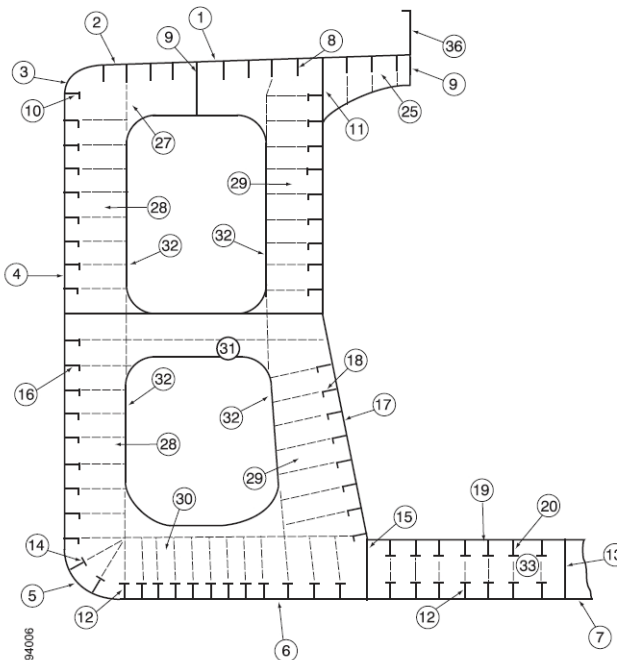

REPORT ON TM2-DSBC (i) and (ii)
① Strength deck plating
② Stringer plate
③ Sheerstrake
④ Side shell plating
⑤ Bilge plating
⑥ Bottom shell plating
⑦ Keel plate

REPORT ON TM6-DSBC
⑩ Hatch coamings
⑩ Deck plating between hatches
⑩ Hatch covers
⑩
⑩

REPORT ON TM3-DSBC
⑧ Deck longitudinals
⑨ Deck girders
⑩ Sheerstrake longitudinals
⑪ Longitudinal bulkhead top strake
⑫ Bottom longitudinals
⑬ Bottom girders
⑭ Bilge longitudinals
⑮ Longitudinal bulkhead lower strake
⑯ Side shell longitudinals
⑰ Longitudinal bulkhead plating (remainder)
⑱ Longitudinal bulkhead longitudinals
⑲ Inner bottom plating
⑳ Inner bottom longitudinals
㉑
㉒
㉓
㉔

REPORT ON TM4-DSBC
㉕ Deck transverse centre tank
㉖ Bottom transverse centre tank
㉗ Deck transverse wing tank
㉘ Side shell vertical web
㉙ Longitudinal bulkhead vertical web
㉚ Bottom transverse wing tank
㉛ Struts
㉜ Transverse web face plate
㉝ Double bottom floors
㉞
㉟

THICKNESS MEASUREMENT – DOUBLE-SIDE SKIN BULK CARRIER

Transverse section outline: the diagram may be used for those ships where the typical transverse sections are not suitable.

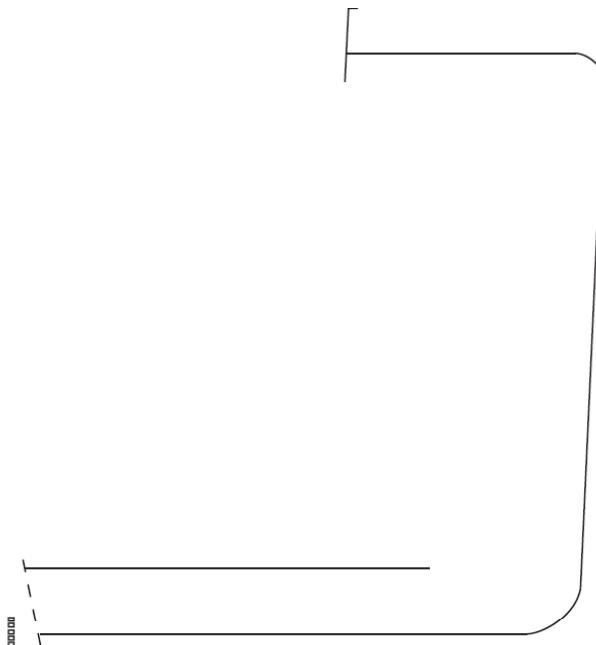

REPORT ON TM2-DSBC(i) and (ii)	
①	Strength deck plating
②	Stringer plate
③	Sheerstrake
④	Side shell plating
⑤	Bilge plating
⑥	Bottom shell plating
⑦	Keel plate

REPORT ON TM3-DSBC	
⑧	Deck longitudinals
⑨	Deck girders
⑩	Sheerstrake longitudinals
⑪	Topside tank sloping plating
⑫	Topside tank sloping plating longitudinals
⑬	Bottom longitudinals
⑭	Bottom girders
⑮	Bilge longitudinals
⑯	Side shell longitudinals, if any
⑰	Inner bottom plating
⑱	Inner bottom longitudinals
⑲	Hopper plating
⑳	Hopper longitudinals
㉑	Inner side plating
	– Inner side longitudinals, if any
	– Horizontal girders in wing ballast tanks

REPORT ON TM4-DSBC	
㉒	Double-bottom tank floors
㉓	Hopper side tank transverses
㉔	Transverse web frame
	– Topside tank transverses

REPORT ON TM6-DSBC	
㉕	Hatch coamings
	– Deck plating between hatches
	– Hatch covers

THICKNESS MEASUREMENT – ORE CARRIERS

Areas subject to close-up survey and thickness measurements – areas (A), (C), (D) and (E) as defined in annex 1 of part B – Thickness to be reported on TM3-DSBC, TM4-DSBC, TM5-DSBC and TM6-DSBC as appropriate

Typical transverse section close-up survey

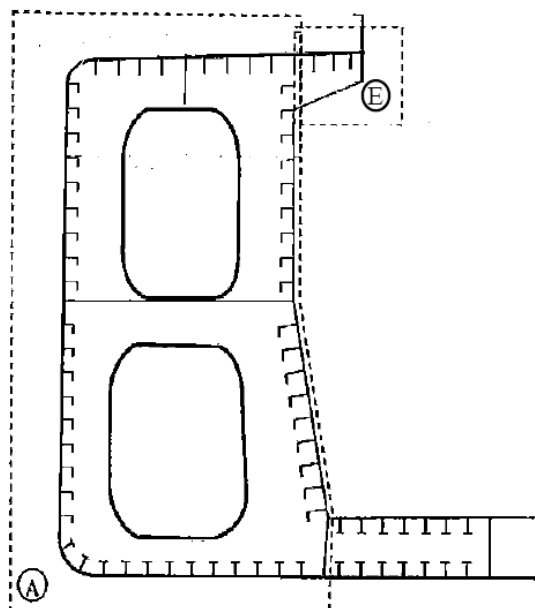

Thickness to be reported on TM3-DSBC and TM4-DSBC as appropriate

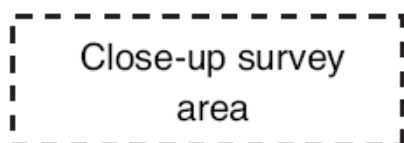

Typical transverse bulkhead

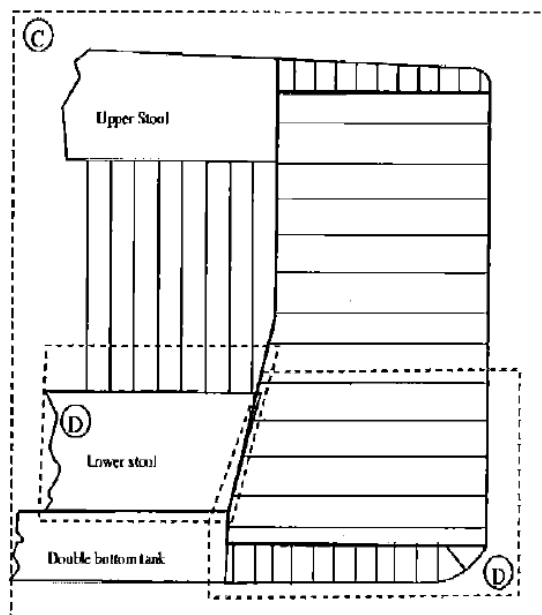

Thickness to be reported on TM5-DSBC

THICKNESS MEASUREMENTS – DOUBLE-SIDE SKIN BULK CARRIER

Areas subject to close-up survey and thickness measurements – areas (A) to (E) as defined in annex 1 of part B – Thickness to be reported on TM3-DSBC, TM4-DSBC, TM5-DSBC and TM6-DSBC as appropriate.

Typical transverse section

Areas (A) and (D)

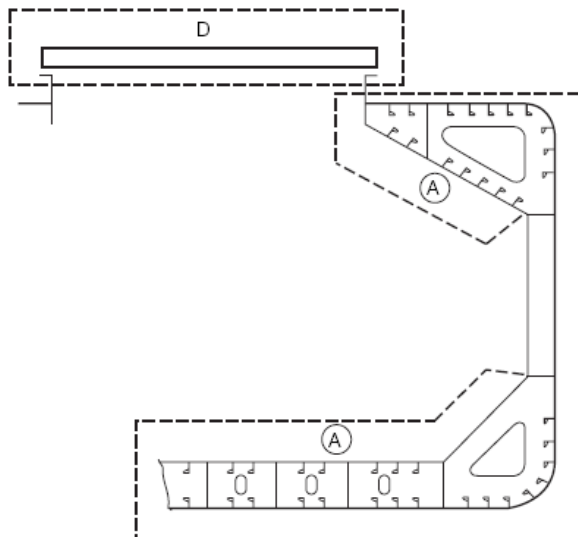

Thickness to be reported on TM3-DSBC, TM4-DSBC, and TM6-DSBC, as appropriate

A cargo hold, transverse bulkhead

Area (C)

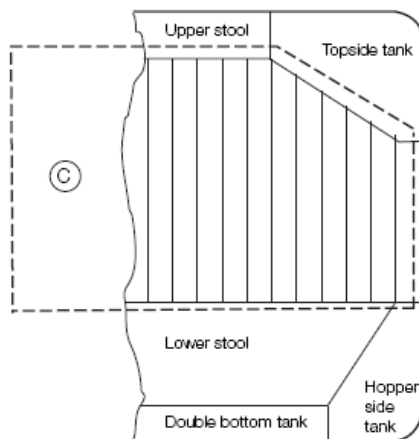

Thickness to be reported on TM5-DSBC

**Typical areas of deck plating and underdeck structure inside line
of hatch openings between cargo hold hatches**

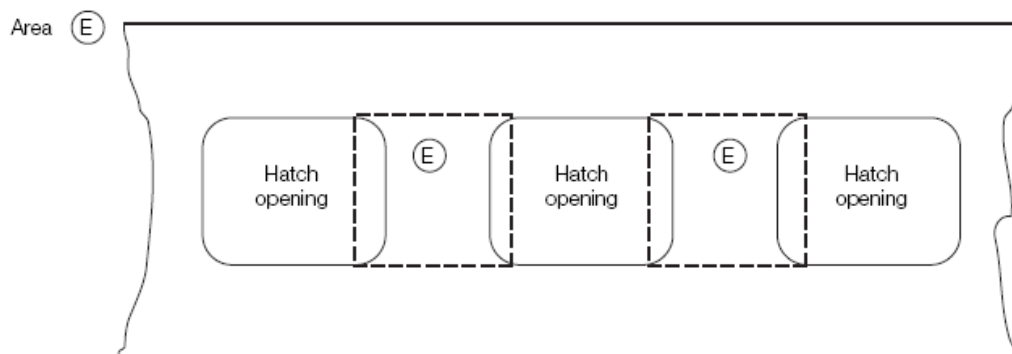

Thickness to be reported on TM1-DSBC

Ordinary transverse frame in double-side skin tank

Area (B)

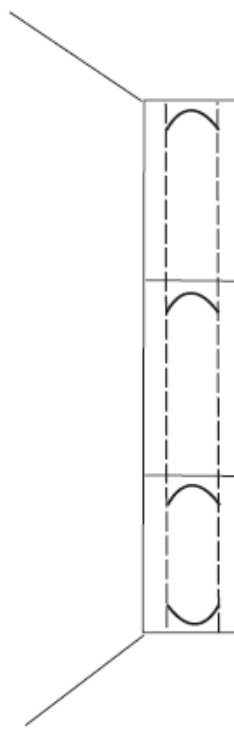

Thickness to be reported on TM4-DSBC

ANNEX 9

**GUIDELINES FOR TECHNICAL ASSESSMENT IN CONJUNCTION WITH
PLANNING FOR ENHANCED SURVEYS OF DOUBLE-SIDE SKIN
BULK CARRIERS – RENEWAL SURVEY HULL****1 Introduction**

These guidelines contain information and suggestions concerning technical assessments, which may be of use in conjunction with the planning of enhanced renewal surveys of double-side skin bulk carriers. As indicated in 5.1.5, the guidelines are a recommended tool which may be invoked at the discretion of the Administration, when considered necessary and appropriate, in conjunction with the preparation of the required survey programme.

2 Purpose and principles**2.1 Purpose**

2.1.1 The purpose of the technical assessments described in these guidelines is to assist in identifying critical structural areas, nominating suspect areas and in focusing attention on structural elements or areas of structural elements which may be particularly susceptible to, or evidence a history of, wastage or damage. This information may be useful in nominating locations, areas holds and tanks for thickness measurement, close-up survey and tank testing.

2.1.2 Critical structural areas are locations which have been identified from calculations to require monitoring or from the service history of the subject ship or from similar or sister ships (if available) to be sensitive to cracking, buckling or corrosion which would impair the structural integrity of the ship.

2.2 Minimum requirements

However, these guidelines may not be used to reduce the requirements pertaining to thickness measurement, close-up survey and tank testing contained in annexes 1 and 2 of part B and in 2.7, respectively, which, in all cases, should be complied with as a minimum.

2.3 Timing

As with other aspects of survey planning, the technical assessments described in these guidelines should be worked out by the owner or operator in cooperation with the Administration well in advance of the commencement of the renewal survey, i.e. prior to commencing the survey and normally at least 12 to 15 months before the survey's completion due date.

2.4 Aspects to be considered

2.4.1 Technical assessments, which may include quantitative or qualitative evaluation of relative risks of possible deterioration, of the following aspects of a particular ship may be used as a basis for the nomination of holds, tanks and areas for survey:

- .1 design features such as stress levels on various structural elements, design details and extent of use of high-tensile steel;

- .2 former history with respect to corrosion, cracking, buckling, indents and repairs for the particular ship as well as similar vessels, where available; and
- .3 information with respect to types of cargo carried, use of different holds/tanks for cargo/ballast, protection of holds and tanks and condition of coating, if any.

2.4.2 Technical assessments of the relative risks of susceptibility to damage or deterioration of various structural elements and areas should be judged and decided on the basis of recognized principles and practices, such as may be found in references 2, 3 and 4.

3 Technical assessment

3.1 General

3.1.1 There are three basic types of possible failure, which may be the subject of technical assessment in connection with planning of surveys; corrosion, cracks and buckling. Contact damages are not normally covered by the survey planning since indents are usually noted in memoranda and assumed to be dealt with as a normal routine by surveyors.

3.1.2 Technical assessments performed in conjunction with the survey planning process should, in principle, be as shown schematically in figure 1.

The approach is basically an evaluation of the risk in the following aspects based on the knowledge and experience related to:

- .1 design; and
- .2 corrosion.

3.1.3 The design should be considered with respect to structural details, which may be susceptible to buckling or cracking as a result of vibration, high stress levels or fatigue.

3.1.4 Corrosion is related to the ageing process, and is closely connected with the quality of corrosion prevention systems fitted at new building, and subsequent maintenance during the service life. Corrosion may also lead to cracking and/or buckling.

3.2 Methods

3.2.1 Design details

3.2.1.1 Damage experience related to the ship in question and sister and/or similar ships, where available, is the main source of information to be used in the process of planning. In addition, a selection of structural details from the design drawings should be included.

3.2.1.2 Typical damage experience to be considered will consist of:

- .1 number, extent, location and frequency of cracks; and
- .2 location of buckles.

3.2.1.3 This information may be found in the survey reports and/or the owner's files, including the results of the owner's own inspections. The defects should be analysed, noted and marked on sketches.

3.2.1.4 In addition, general experience should be utilized. Also, reference should be made to reference 2, which contains a catalogue of typical damages and proposed repair methods for various structural details on single-skin bulk carriers. Reference should also be made to reference 3, which contains catalogues of typical damages and proposed repair methods for double-hull oil tanker structural details which may to some extent be similar to structural details in double-side skin bulk carriers. Such figures should be used together with a review of the main drawings, in order to compare with the actual structure and search for similar details that may be susceptible to damage. In particular, chapter 3 of reference 3 deals with various aspects specific to double-hull tankers, such as stress concentration locations, misalignment during construction, corrosion trends, fatigue considerations and areas requiring special attention, while chapter 4 of reference 3 addresses experience gained on structural defects in double-hulls (chemical tankers, OBO carriers, ore/oil carriers, gas carriers), which should also be considered in working out the survey planning.

3.2.1.5 The review of the main structural drawings, in addition to using the above-mentioned figures, should include checking for typical design details where cracking has been experienced. The factors contributing to damage should be carefully considered.

3.2.1.6 The use of high-tensile steel (HTS) is an important factor. Details showing good service experience where ordinary, mild steel has been used may be more susceptible to damage when HTS, and its higher associated stresses, are utilized. There is extensive and, in general, good experience, with the use of HTS for longitudinal material in deck and bottom structures. Experience in other locations, where the dynamic stresses may be higher, is less favourable, e.g. side structures.

3.2.1.7 In this respect, stress calculations of typical and important components and details, in accordance with relevant methods, may prove useful and should be considered.

3.2.1.8 The selected areas of the structure identified during this process should be recorded and marked on the structural drawings to be included in the survey programme.

3.2.2 *Corrosion*

3.2.2.1 In order to evaluate relative corrosion risks, the following information should generally be considered:

- .1 usage of tanks, holds and spaces;
- .2 condition of coatings;
- .3 cleaning procedures;
- .4 previous corrosion damage;
- .5 ballast use and time for cargo holds;
- .6 risk of corrosion in cargo holds and ballast tanks; and
- .7 location of ballast tanks adjacent to heated fuel oil tanks.

3.2.2.2 Reference 4 gives definitive examples which can be used for judging and describing coating condition, using typical pictures of conditions.

3.2.2.3 The evaluation of corrosion risks should be based on information in both reference 2 and reference 4, as far as applicable to double-side skin construction, together with relevant information on the anticipated condition of the ship as derived from the information collected in order to prepare the survey programme and the age of the ship. The various holds, tanks and spaces should be listed with the corrosion risks nominated accordingly.

3.2.3 *Locations for close-up survey and thickness measurement*

3.2.3.1 On the basis of the table of corrosion risks and the evaluation of design experience, the locations for initial close-up survey and thickness measurement (areas and sections) may be nominated.

3.2.3.2 The sections subject to thickness measurement should normally be nominated in tanks, holds and spaces where corrosion risk is judged to be the highest.

3.2.3.3 The nomination of tanks, holds and spaces for close-up survey should initially be based on highest corrosion risk, and should always include ballast tanks. The principle for the selection should be that the extent is increased by age or where information is insufficient or unreliable.

References

- 1 IACS, Unified Requirement Z10.5, Hull Surveys of Double Skin Bulk Carriers
- 2 IACS, Bulk Carriers: Guidelines for Surveys, Assessment and Repair of Hull Structures, January 2007
- 3 TSCF, Guidelines for the Inspection and Maintenance of Double Hull Tanker Structures, 1995
- 4 TSCF, Guidance Manual for Tanker Structures, 1997

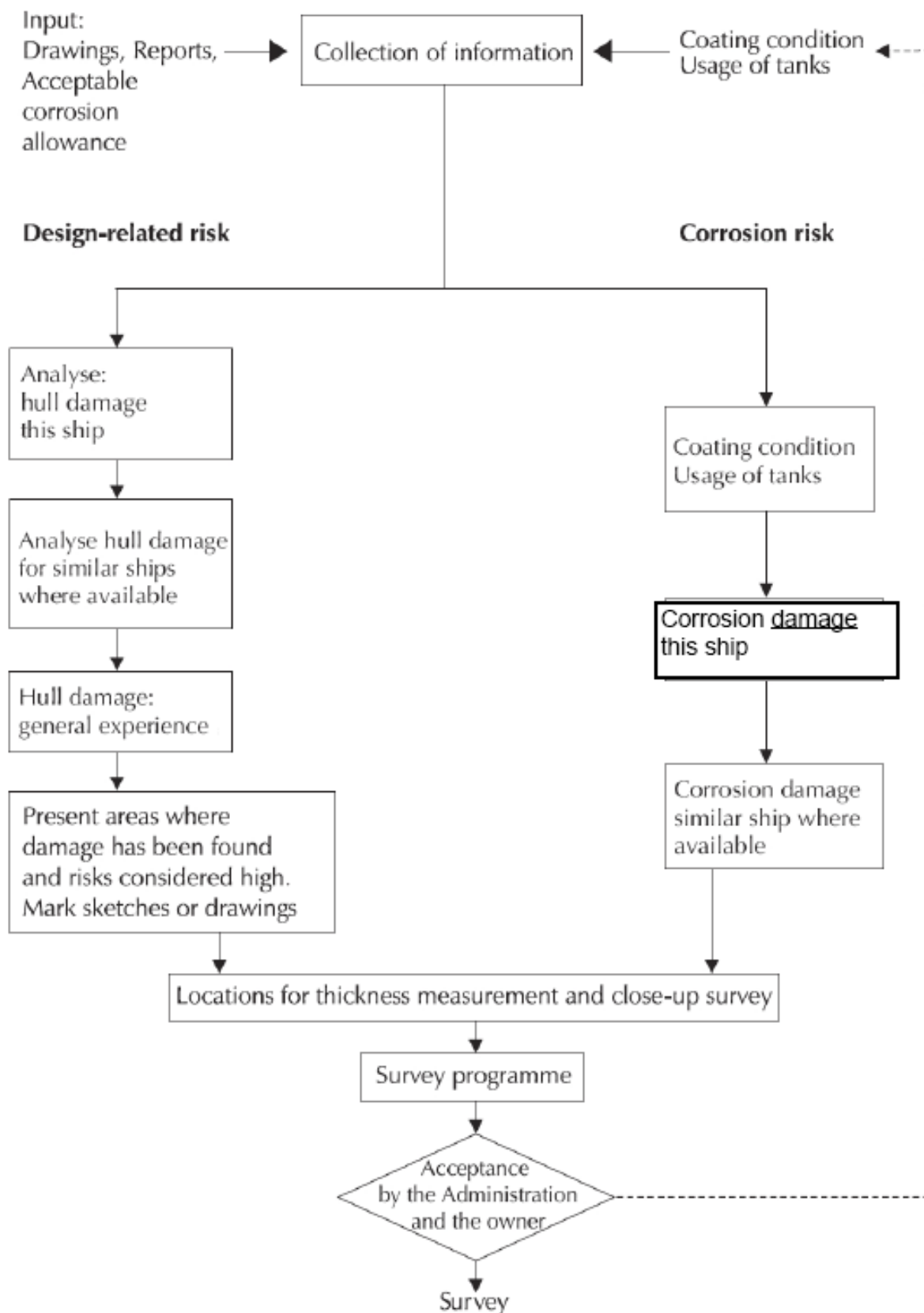

Figure 1 – Technical assessment and the survey planning process

ANNEX 10

REQUIREMENTS FOR EXTENT OF THICKNESS MEASUREMENTS AT THOSE AREAS OF SUBSTANTIAL CORROSION OF BULK CARRIERS WITH DOUBLE-SIDE SKIN CONSTRUCTION WITHIN THE CARGO LENGTH AREA

Table 1 – Bottom, inner bottom and hopper structure

Structural member	Extent of measurement	Pattern of measurement
Bottom, inner bottom and hopper structure plating	Minimum of three bays across double-bottom tank, including aft bay Measurements around and under all suction bell mouths	Five-point pattern for each panel between longitudinals and floors
Bottom, inner bottom and hopper structure longitudinals	Minimum of three longitudinals in each bay where bottom plating measured	Three measurements in line across flange and three measurements on the vertical web
Bottom girders, including the watertight ones	At fore and aft watertight floors and in centre of tanks	Vertical line of single measurements on girder plating with one measurement between each panel stiffener, or a minimum of three measurements
Bottom floors, including the watertight ones	Three floors in the bays where bottom plating measured, with measurements at both ends and middle	Five-point pattern over 2 m ² area
Hopper structure web frame ring	Three floors in bays where bottom plating measured	Five-point pattern over 1 m ² of plating Single measurements on flange
Hopper structure transverse watertight bulkhead or swash bulkhead	– lower 1/3 of bulkhead	five-point pattern over 1 m ² of plating
	– upper 2/3 of bulkhead	five-point pattern over 2 m ² of plating
	– stiffeners (minimum of three)	For web, five-point pattern over span (two measurements across web at each end and one at centre of span). For flange, single measurements at each end and centre of span
Panel stiffening	Where applicable	Single measurements

Table 2 – Deck structure including cross strips, main cargo hatchways, hatch covers, coamings and topside tanks

Structural member	Extent of measurement	Pattern of measurement
Cross deck strip plating	Suspect cross deck strip plating	Five-point pattern between under deck stiffeners over 1 m length
Under deck stiffeners	Transverse members Longitudinal member	Five-point pattern at each end and mid span Five-point pattern on both web and flange
Hatch covers	Side and end skirts, each three locations Three longitudinal bands, outboard strakes (2) and centerline strake (1)	Five-point pattern at each location Five-point measurement each band
Hatch coamings	Each side and end of coaming, one band lower 1/3, one band upper 2/3 of coaming	Five-point measurement each band, i.e. end or side coaming
Topside ballast tanks	a) watertight transverse bulkheads: – Lower 1/3 of bulkhead – Upper 2/3 of bulkhead – Stiffeners	Five-point pattern over 1 m ² of plating Five-point pattern over 1 m ² of plating Five-point pattern over 1 m length
Topside ballast tanks	b) two representative swash transverse bulkheads: – Lower 1/3 of bulkhead – Upper 2/3 of bulkhead – Stiffeners	Five-point pattern over 1 m ² of plating Five-point pattern over 1 m ² of plating Five-point pattern over 1 m length
Topside ballast tanks	c) three representative bays of slope plating: – Lower 1/3 of tank – Upper 2/3 of tank	Five-point pattern over 1 m ² of plating Five point pattern over 1 m ² of plating

Structural member	Extent of measurement	Pattern of measurement
Topside ballast tanks	d) Longitudinals, suspect and adjacent	Five point pattern on both web and flange over 1 m length
Main deck plating	Suspect plates and adjacent (4)	Five-point pattern over 1 m ² of plating
Main deck longitudinals	Suspect plates	Five point pattern on both web and flange over 1 m length
Web frames/transverses	Suspect plates	Five-point pattern over 1 m ² of plating

Table 3 – Structure in double-side spaces of double-side skin bulk carriers including wing void spaces of ore carriers

Structural member	Extent of measurement	Pattern of measurement
Side shell and inner plating: – Upper strake and strakes in way of horizontal girders – All other strakes	– Plating between each pair of transverse frames/longitudinals in a minimum of three bays (along the tank) – Plating between every third pair of longitudinals in same three bays	– Single measurement – Single measurement
Side shell and inner side transverse frames/ longitudinals on: – upper strake – all other strakes	– Each transverse frame/ longitudinal in same three bays – Every third transverse frame/longitudinal in same three bays	– Three measurements across web and one measurement on flange – Three measurements across web and one measurement on flange
Transverse frames/ longitudinals: – brackets	Minimum of three at top, middle and bottom of tank in same three bays	Five-point pattern over area of bracket
Vertical web and transverse bulkheads: – strakes in a way of horizontal girders – other strakes	– Minimum of two webs and both transverse bulkheads – Minimum of two webs and both transverse bulkheads	– Five-point pattern over approximately 2 m ² area – Two measurements between each pair of vertical stiffeners
Horizontal girders	Plating on each girder in a minimum of three bays	Two measurements between each pair of longitudinal girder stiffeners
Panel stiffening	Where applicable	Single measurements

Table 4 – Transverse bulkheads in cargo holds

Structural member	Extent of measurement	Pattern of measurement
Lower stool, where fitted	– Transverse band within 25 mm of welded connection to inner bottom – Transverse bands within 25 mm of welded connection to shelf plate	– Five-point pattern between stiffeners over 1 m length – Five-point pattern between stiffeners over 1 m length
Transverse bulkheads	– Transverse band at approximately mid height – Transverse band at part of bulkhead adjacent to upper deck or below upper stool shelf plate (for those ships fitted with upper stools)	– Five-point pattern over 1 m ² of plating – Five-point pattern over 1 m ² of plating

ANNEX 11

STRENGTH OF CARGO HATCH COVER SECURING ARRANGEMENTS FOR BULK CARRIERS

1 Securing devices

The strength of securing devices should comply with the following requirements:

- .1 Panel hatch covers should be secured by appropriate devices (bolts, wedges or similar) suitably spaced alongside the coamings and between cover elements. Arrangement and spacing should be determined with due attention to the effectiveness for weathertightness, depending upon the type and the size of the hatch cover, as well as on the stiffness of the cover edges between the securing devices.

- .2 The net sectional area of each securing device should not be less than:

$$A = 1.4 a/f \text{ (cm}^2\text{)}$$

where:

- a = spacing between securing devices not to be taken less than 2 m
 f = $(\sigma_Y / 235)^e$
 σ_Y = specified minimum upper yield stress in N/mm² of the steel used for fabrication, not to be taken greater than 70 per cent of the ultimate tensile strength
 e = 0.75 for $\sigma_Y > 235$
 = 1.0 for $\sigma_Y \leq 235$

Rods or bolts should have a net diameter not less than 19 mm for hatchways exceeding 5 m² in area.

- .3 Between cover and coaming and at cross-joints, a packing line pressure sufficient to obtain weathertightness should be maintained by the securing devices. For packing line pressures exceeding 5 N/mm, the cross section area should be increased in direct proportion. The packing line pressure should be specified.

- .4 The cover edge stiffness should be sufficient to maintain adequate sealing pressure between securing devices. The moment of inertia, I , of edge elements should not be less than:

$$I = 6 p a^4 \text{ (cm}^4\text{)}$$

where:

- p = packing line pressure in N/mm, minimum 5 N/mm
 a = spacing in metres of securing devices.

- .5 Securing devices should be of reliable construction and securely attached to the hatchway coamings, decks or covers. Individual securing devices on each cover should have approximately the same stiffness characteristics.

- .6 Where rod cleats are fitted, resilient washers or cushions should be incorporated.
- .7 Where hydraulic cleating is adopted, a positive means should be provided to ensure that it remains mechanically locked in the closed position in the event of failure of the hydraulic system.

2 Stoppers

2.1 Nos. 1 and 2 hatch covers should be effectively secured, by means of stoppers, against the transverse forces arising from a pressure of 175 kN/m².

2.2 No.2 hatch covers should be effectively secured, by means of stoppers, against the longitudinal forces acting on the forward end arising from a pressure of 175 kN/m².

2.3 No.1 hatch cover should be effectively secured, by means of stoppers, against the longitudinal forces acting on the forward end arising from a pressure of 230 kN/m². This pressure may be reduced to 175 kN/m² if a forecastle is fitted.

2.4 The equivalent stress in stoppers and their supporting structures and calculated in the throat of the stopper welds is not to exceed the allowable value of $0.8 \sigma_Y$.

3 Materials and welding

Where stoppers or securing devices are fitted to comply with this annex, they should be manufactured of materials, including welding electrodes, to the satisfaction of the Administration.

ANNEX 12

PROCEDURAL REQUIREMENTS FOR THICKNESS MEASUREMENTS**1 General**

Thickness measurements required in the context of hull structural surveys, if not carried out by the society itself should be witnessed by a surveyor. The attendance of the surveyor should be recorded. This also applies to thickness measurements taken during voyages.

2 Survey meeting

2.1 Prior to commencement of the renewal or intermediate survey, a meeting should be held between the attending surveyor(s), the owner's representative(s) in attendance and the thickness measurement firm's representative(s) so as to ensure the safe and efficient execution of the surveys and thickness measurements to be carried out on board.

2.2 Communication with the thickness measurement operator(s) and owner's representative(s) should be agreed during the meeting, with respect to the following:

- .1 reporting of thickness measurements on a regular basis;
- .2 prompt notification to the surveyor in case of findings such as:
 - .1 excessive and/or extensive corrosion or pitting/grooving of any significance;
 - .2 structural defects like buckling, fractures and deformed structures;
 - .3 detached and/or holed structure; and
 - .4 corrosion of welds.

2.3 The survey report should indicate where and when the meeting took place and who attended (the name of the surveyor(s), the owner's representative(s) and the thickness measurement firm's representative(s)).

3 Monitoring of the thickness measurement process on board

3.1 The surveyor should decide final extent and location of thickness measurements after overall survey of representative spaces on board.

3.2 In case the owner prefers to commence the thickness measurements prior to the overall survey, then the surveyor should advise that the planned extent and locations of thickness measurements are subject to confirmation during the overall survey. Based on findings, the surveyor may require additional thickness measurements to be taken.

3.3 The surveyor should direct the gauging operation by selecting locations such that readings taken represent, on average, the condition of the structure for that area.

3.4 Thickness measurements taken mainly to evaluate the extent of corrosion, which may affect the hull girder strength, should be carried out in a systematic manner such that all longitudinal structural members are gauged, as required.

3.5 Where thickness measurements indicate substantial corrosion or wastage in excess of allowable diminution, the surveyor should direct locations for additional thickness measurements in order to delineate areas of substantial corrosion and to identify structural members for repairs/renewals.

3.6 Thickness measurements of structures in areas where close-up surveys are required should be carried out simultaneously with close-up survey.

4 Review and verification

4.1 Upon completion of the thickness measurements, the surveyor should confirm that no further gaugings are needed, or specify additional gaugings.

4.2 Where these guidelines allow the extent of thickness measurements to be reduced after special considerations by the surveyor, these special considerations should be reported, where appropriate.

4.3 In case thickness measurements are partly carried out, the extent of remaining thickness measurements should be reported for the use of the next surveyor.

ANNEX B

**CODE ON THE ENHANCED PROGRAMME OF INSPECTIONS
DURING SURVEYS OF OIL TANKERS****Part A****CODE ON THE ENHANCED PROGRAMME OF INSPECTIONS
DURING SURVEYS OF DOUBLE-HULL OIL TANKERS****1 General****1.1 Application⁸**

1.1.1 The Code should apply to all self-propelled double-hull oil tankers of 500 gross tonnage and above.

1.1.2 The Code should apply to surveys of hull structure and piping systems in way of cargo tanks, pump-rooms, cofferdams, pipe tunnels, void spaces within the cargo area and all ballast tanks.

1.1.3 The Code contains the minimum extent of examination, thickness measurements and tank testing. The survey should be extended when substantial corrosion and/or structural defects are found and include additional close-up survey when necessary.

1.1.4 The surveys should be carried out during the surveys prescribed by regulation I/10 of the Convention.

1.2 Definitions

1.2.1 *Double-hull oil tanker* is a ship which is constructed primarily for the carriage of oil⁹ in bulk, which has the cargo tanks protected by a double-hull which extends for the entire length of the cargo area, consisting of double sides and double-bottom spaces for the carriage of water ballast or void spaces.

1.2.2 *Ballast tank* is a tank which is used solely for the carriage of salt water ballast.

1.2.3 *Combined cargo/ballast tank*, if referred to within the Code, is a tank which is used for the carriage of cargo or ballast water as a routine part of the vessel's operation and will be treated as a Ballast Tank. Cargo tanks in which water ballast might be carried only in exceptional cases per MARPOL regulation I/18.3 are to be treated as cargo tanks.

1.2.4 *Overall survey* is a survey intended to report on the overall condition of the hull structure and determine the extent of additional close-up surveys.

⁸ The intention of the Code is to ensure that an appropriate level of review of plans and documents is conducted and consistency in application is attained. Such evaluation of survey reports, survey programmes, planning documents, etc., should be carried out at the managerial level of the Administration or organization recognized by the Administration.

⁹ MARPOL Annex I cargoes. The requirements of these Guidelines are also applicable to existing double-hull tankers not complying with MARPOL regulation I/19, but having a U-shaped midship section.

1.2.5 *Close-up survey* is a survey where the details of structural components are within the close visual inspection range of the surveyor, i.e. normally within reach of hand.

1.2.6 *Transverse section* is the cross section of the hull perpendicular to the ship's centerline and includes all longitudinal members such as plating, longitudinals and girders at the deck, sides, bottom, inner bottom and longitudinal bulkheads.

1.2.7 *Representative tanks* are those which are expected to reflect the condition of other tanks of similar type and service and with similar corrosion prevention systems. When selecting representative tanks, account should be taken of the service and repair history on board and identifiable critical and/or suspect areas.

1.2.8 *Suspect areas* are locations showing substantial corrosion and/or are considered by the surveyor to be prone to rapid wastage.

1.2.9 *Substantial corrosion* is an extent of corrosion such that assessment of corrosion pattern indicates a wastage in excess of 75 per cent of allowable margins, but within acceptable limits. For ships built under the IACS Common Structural Rules, substantial corrosion is an extent of corrosion such that the assessment of the corrosion pattern indicates a gauged (or measured) thickness between $t_{net} + 0.5\text{mm}$ and t_{net} .

1.2.10 *Corrosion prevention system* is normally considered a full hard coating. Hard protective coating should usually be epoxy coating or equivalent. Other coating systems, which are neither soft nor semi-hard coatings, may be considered acceptable as alternatives provided that they are applied and maintained in compliance with the manufacturer's specification.

1.2.11 *Coating condition* is defined as follows:

GOOD condition with only minor spot rusting;

FAIR condition with local breakdown of coating at edges of stiffeners and weld connections and/or light rusting over 20 per cent or more of areas under consideration, but less than as defined for POOR condition; and

POOR condition with general breakdown of coating over 20 per cent or more of areas or hard scale at 10 per cent or more of areas under consideration.

1.2.12 *Critical structural areas* are locations which have been identified from calculations to require monitoring or from the service history of the subject ship or from similar or sister ships to be sensitive to cracking, buckling or corrosion which would impair the structural integrity of the ship.

1.2.13 *Cargo area* is that part of the ship which contains cargo tanks, slop tanks and cargo/ballast pump-rooms, cofferdams, ballast tanks and void spaces adjacent to cargo tanks and also deck areas throughout the entire length and breadth of the part of the ship over the above mentioned spaces.

1.2.14 *Intermediate survey* is a survey carried out either at the second or the third annual survey.

1.2.15 *Prompt and thorough repair* is a permanent repair completed at the time of survey to the satisfaction of the surveyor, therein removing the need for the imposition of any associated condition of classification or recommendation.

1.2.16 *Specially considered* (in connection with close-up surveys and thickness measurements) means sufficient close-up inspection and thickness measurements are taken to confirm the actual average condition of the structure under coating.

1.3 *Repairs*

1.3.1 Any damage in association with wastage over the allowable limits (including buckling, grooving, detachment or fracture), or extensive areas of wastage over the allowable limits, which affects or, in the opinion of the Administration, will affect the ship's structural, watertight or weathertight integrity, should be promptly and thoroughly (see 1.2.15) repaired. Areas to be considered include:

- .1 bottom structure and bottom plating;
- .2 side structure and side plating;
- .3 deck structure and deck plating;
- .4 watertight or oiltight bulkheads; and
- .5 hatch covers and hatch coamings, where fitted.

For locations where adequate repair facilities are not available, the Administration may allow the ship to proceed directly to a repair facility. This may require discharging the cargo and/or temporary repairs for the intended voyage.

1.3.2 Additionally, when a survey results in the identification of corrosion or structural defects, either of which, in the opinion of the Administration, will impair the ship's fitness for continued service, remedial measures should be implemented before the ship continues in service.

1.4 *Surveyors*

For tankers of 20,000 tons deadweight and above, two surveyors should jointly carry out the first scheduled renewal survey after the tanker passes 10 years of age (i.e. third renewal survey), and all subsequent renewal surveys and intermediate surveys. If the surveys are carried out by a recognized organization, the surveyors should be exclusively employed by such recognized organizations.

1.5 *Thickness measurements and close-up surveys*

In any kind of survey, i.e. renewal, intermediate, annual or other surveys having the scope of the foregoing ones, thickness measurements of structures in areas where close-up surveys are required should be carried out simultaneously with close-up surveys.

2 Renewal survey

2.1 *General*

2.1.1 The renewal survey may be commenced at the fourth annual survey and be progressed during the succeeding year with a view to completion by the fifth anniversary date.

2.1.2 As part of the preparation for the renewal survey the survey programme should be dealt with in advance of the renewal survey. The thickness measurement should not be carried out before the fourth annual survey.

2.1.3 The survey should include, in addition to the requirements of the annual survey, examination, tests and checks of sufficient extent to ensure that the hull and related piping as required in 2.1.5 is in a satisfactory condition and is fit for its intended purpose for the new period of validity of the Cargo Ship Safety Construction Certificate, subject to proper maintenance and operation and to periodical surveys being carried out at the due dates.

2.1.4 All cargo tanks, ballast tanks, and any other tanks in double-hull spaces, pump-rooms, pipe tunnels, cofferdams and void spaces bounding cargo tanks, decks and outer hull should be examined, and this examination should be supplemented by thickness measurement and testing as required in 2.5 and 2.6, to ensure that the structural integrity remains effective. The aim of the examination is to discover substantial corrosion, significant deformation, fractures, damages or other structural deterioration that may be present.

2.1.5 Cargo piping on deck, including crude oil washing (COW) piping, and cargo and ballast piping within the above tanks and spaces should be examined and operationally tested to working pressure to attending surveyor's satisfaction to ensure that tightness and condition remain satisfactory. Special attention should be given to any ballast piping in cargo tanks and any cargo piping in ballast tanks and void spaces, and surveyors should be advised on all occasions when this piping, including valves and fittings, are open during repair periods and can be examined internally.

2.2 *Dry-dock survey*

2.2.1 A survey in dry-dock should be a part of the renewal survey. There should be a minimum of two inspections of the outside of the ship's bottom during the five-year period of the Safety Construction Certificate. In all cases, the maximum interval between bottom inspections should not exceed 36 months.

2.2.2 For ships of 15 years of age and over, inspection of the outside of the ship's bottom should be carried out with the ship in dry-dock. For ships of less than 15 years of age, alternate inspections of the ship's bottom not conducted in conjunction with the renewal survey may be carried out with the ship afloat. Inspection of the ship afloat should only be carried out when the conditions are satisfactory and the proper equipment and suitably qualified staff is available.

2.2.3 If a survey in dry-dock is not completed in conjunction with the renewal survey or if the 36 month maximum interval referred to in 2.2.1 is not complied with, the Cargo Ship Safety Construction Certificate should cease to be valid until a survey in dry-dock is completed.

2.2.4 The overall and close-up surveys and thickness measurements, as applicable, of the lower portions of the cargo tanks and ballast tanks should be carried out in accordance with the applicable requirements for renewal surveys, if not already performed.

Note: Lower portions of the cargo and ballast tanks are considered to be the parts below light ballast water line.

2.3 *Tank corrosion prevention system*

Where provided, the condition of the corrosion prevention system of cargo tanks should be examined. A ballast tank should be examined at subsequent annual intervals where:

- .1 a hard protective coating has not been applied from the time of construction; or
- .2 a soft or semi-hard coating has been applied; or
- .3 substantial corrosion is found within the tank; or
- .4 the hard protective coating is found to be in less than GOOD condition and the hard protective coating is not repaired to the satisfaction of the surveyor.

Thickness measurement should be carried out as deemed necessary by the surveyor.

2.4 *Extent of overall and close-up surveys*

2.4.1 An overall survey of all tanks and spaces should be carried out at the renewal survey. Suspect areas identified at previous surveys should be examined.

2.4.2 The minimum requirements for close-up surveys at the renewal survey are given in annex 1.

2.4.3 The surveyor may extend the scope of the close-up survey as deemed necessary taking into account the maintenance of the tanks under survey, the condition of the corrosion prevention system and also in the following cases:

- .1 in particular, tanks having structural arrangements or details which have suffered defects in similar tanks or on similar ships according to available information; and
- .2 in tanks which have structures with reduced scantlings in association with a corrosion prevention system approved by the Administration.

2.4.4 For areas in tanks where hard protective coatings are found to be in GOOD condition as defined in 1.2.11, the extent of close-up surveys according to annex 1 may be specially considered by the Administration.

2.5 *Extent of thickness measurements*

2.5.1 The minimum requirements for thickness measurements at the renewal survey are given in annex 2.

2.5.2 Provisions for extended measurements for areas with substantial corrosion are given in annex 4, and may be additionally specified in the survey programme as required in 5.1. These extended thickness measurements should be carried out before the survey is credited as completed. Suspect areas identified at previous surveys should have thickness measurements taken.

2.5.3 The surveyor may further extend the thickness measurements as deemed necessary.

2.5.4 For areas in tanks where hard protective coatings are found to be in GOOD condition as defined in 1.2.11, the extent of thickness measurements according to annex 2 may be specially considered by the Administration.

2.5.5 Transverse sections should be chosen where the largest reductions are suspected to occur or are revealed from deck plating measurements.

2.5.6 In cases where two or three sections are to be measured, at least one should include a ballast tank within 0.5L amidships. In case of oil tankers of 130 m in length and upwards (as defined in the International Convention on Load Lines in force) and more than 10 years of age, for the evaluation of the ship's longitudinal strength as required in 8.2, the sampling method of thickness measurements is given in annex 12.

2.6 *Extent of tank pressure testing*

2.6.1 The minimum requirements for tank pressure testing at the renewal survey are given in annex 3.

2.6.2 The surveyor may extend the tank pressure testing as deemed necessary.

2.6.3 Boundaries of ballast tanks should be tested with a head of liquid to the top of air pipes.

2.6.4 Boundaries of cargo tanks should be tested to the highest point that liquid will rise under service conditions.

2.6.5 The testing of double-bottom tanks and other spaces not designed for the carriage of liquid may be omitted, provided a satisfactory internal examination together with an examination of the tanktop is carried out.

3 **Annual survey**

3.1 *General*

The annual survey should consist of an examination for the purpose of ensuring, as far as practicable, that the hull and piping are maintained in a satisfactory condition and should take into account the service history, condition and extent of the corrosion prevention system of ballast tanks and areas identified in the survey report file.

3.2 *Examination of the hull*

3.2.1 Examination of the hull plating and its closing appliances should be carried out as far as can be seen.

3.2.2 Examination of watertight penetrations should be carried out as far as practicable.

3.3 *Examination of weather decks*

3.3.1 Examination of cargo tank openings including gaskets, covers, coamings and flame screens.

3.3.2 Examination of cargo tank pressure/vacuum valves and flame screens.

3.3.3 Examination of flame screens on vents to all bunker tanks.

3.3.4 Examination of cargo, crude oil washing, bunker and vent piping systems, including vent masts and headers.

3.4 *Examination of cargo pump-rooms and pipe tunnels if fitted*

3.4.1 Examination of all pump-room bulkheads for signs of oil leakage or fractures and, in particular, the sealing arrangements of all penetrations of pump-room bulkheads.

3.4.2 Examination of the condition of all piping systems and pipe tunnels.

3.5 *Examination of ballast tanks*

3.5.1 Examination of ballast tanks should be carried out when required as a consequence of the results of the renewal survey and intermediate survey. When considered necessary by the Administration or when extensive corrosion is found, thickness measurements should be carried out.

3.5.2 Where substantial corrosion as defined in 1.2.9 is found, the extent of thickness measurements should be increased in accordance with the requirements in annex 4. These extended thickness measurements should be carried out before the survey is credited as completed. Suspect areas identified at previous surveys should be examined. Areas of substantial corrosion identified at previous surveys should have thickness measurements taken.

4 Intermediate survey

4.1 *General*

4.1.1 Items that are additional to the requirements of the annual survey may be surveyed either at the second or third annual survey or between these surveys.

4.1.2 The survey extent of cargo and ballast tanks dependent on the age of the ship is specified in 4.2, 4.3 and 4.4 and shown in annex 5.

4.1.3 For weather decks, an examination as far as applicable of cargo, crude oil washing, bunker, ballast, steam and vent piping systems as well as vent masts and headers should be carried out. If upon examination there is any doubt as to the condition of the piping, the piping may be required to be pressure tested, thickness measured or both.

4.1.4 Concurrent crediting to both intermediate survey and renewal survey for surveys and thickness measurements of spaces should not be acceptable.

4.2 *Oil tankers 5 to 10 years of age*

4.2.1 The requirements of 4.1.3 apply.

4.2.2 For tanks used for salt-water ballast, an overall survey of representative tanks selected by the surveyor should be carried out. If the overall survey of salt water ballast tanks reveals no visible structural defects, the examination may be limited to verification that the protective coatings remain in GOOD condition.

4.2.3 A ballast tank should be examined at subsequent annual intervals where:

- .1 a hard protective coating has not been applied from the time of construction; or
- .2 a soft or semi-hard coating has been applied; or
- .3 substantial corrosion is found within the tank; or
- .4 the hard protective coating is found to be in less than GOOD condition and the hard protective coating is not repaired to the satisfaction of the surveyor.

4.3 *Oil tankers 10 to 15 years of age*

4.3.1 The requirements of the intermediate survey should be to the same extent as the previous renewal survey as required in 2 and 5.1. However, pressure testing of cargo and ballast tanks and the requirements for longitudinal strength evaluation of hull girder as required in 8.1.2 are not required unless deemed necessary by the Administration.

4.3.2 In application of 4.3.1, the intermediate survey may be commenced at the second annual survey and be progressed during the succeeding year with a view to completion at the third annual survey in lieu of application of 2.1.1.

4.3.3 In application of 4.3.1., an underwater survey may be considered in lieu of the requirements of 2.2.

4.4 *Oil tankers exceeding 15 years of age*

4.4.1 The requirements of the intermediate survey should be to the same extent as the previous renewal survey as required in 2 and 5.1. However, pressure testing of cargo and ballast tanks and the requirements for longitudinal strength evaluation of hull girder as required in 8.1.2 are not required unless deemed necessary by the Administration.

4.4.2 In application of 4.4.1, the intermediate survey may be commenced at the second annual survey and be progressed during the succeeding year with a view to completion at the third annual survey in lieu of the application of 2.1.1.

4.4.3 In application of 4.4.1, a survey in dry-dock should be part of the intermediate survey. The overall and close-up surveys and thickness measurements, as applicable, of the lower portions of the cargo tanks and water ballast tanks should be carried out in accordance with the applicable requirements for intermediate surveys, if not already carried out.

Note: Lower portions of the cargo and ballast tanks are considered to be the parts below light ballast water line.

5 Preparations for survey

5.1 *Survey programme*

5.1.1 The owner in cooperation with the Administration or organization recognized by the Administration should work out a specific survey programme prior to the commencement of any part of:

- .1 the renewal survey; and
- .2 the intermediate survey for oil tanker over 10 years of age.

The survey programme at intermediate survey may consist of the survey programme at the previous renewal survey supplemented by the condition evaluation report of that renewal survey and later relevant survey reports. The survey programme should be worked out taking into account any amendments to the survey requirements implemented after the last renewal survey carried out. The survey programme should be in a written format based on the information in annex 6A. The survey should not commence until the survey programme has been agreed.

5.1.1.1 Prior to the development of the survey programme, the survey planning questionnaire should be completed by the owner, based on the information set out in annex 6B, and forwarded to the Administration.

5.1.2 In developing the survey programme, the following documentation should be collected and consulted with a view to selecting tanks, areas, and structural elements to be examined:

- .1 survey status and basic ship information;
- .2 documentation on board, as described in 6.2 and 6.3;
- .3 main structural plans of cargo and ballast tanks (scantlings drawings), including information regarding use of high-tensile steels (HTS);
- .4 Condition Evaluation Report, according to annex 9;
- .5 relevant previous damage and repair history;
- .6 relevant previous survey and inspection reports from both the recognized organization and the owner;
- .7 cargo and ballast history for the last three years, including carriage of cargo under heated conditions;
- .8 details of the inert gas plant and tank cleaning procedures;
- .9 information and other relevant data regarding conversion or modification of the ship's cargo and ballast tanks since the time of construction;
- .10 description and history of the coating and corrosion protection system (including anodes and previous class notations), if any;
- .11 inspections of the owner's personnel during the last three years with reference to structural deterioration in general, leakages in tank boundaries and piping and condition of the coating and corrosion protection system (including anodes) if any. Guidance for reporting is shown in annex 5;
- .12 information regarding the relevant maintenance level during operation including port State control reports of inspection containing hull related deficiencies, safety management system non-conformities relating to hull maintenance, including the associated corrective action(s); and

- .13 any other information that will help identify suspect areas and critical structural areas.

5.1.3 The submitted survey programme should account for and comply, as a minimum, with the requirements of 2.6 and annexes 1, 2 and 3 for close-up survey, thickness measurement and tank testing, respectively, and should include relevant information including at least:

- .1 basic ship information and particulars;
- .2 main structural plans of cargo and ballast tanks (scantling drawings), including information regarding use of high tensile steels (HTS);
- .3 plan of tanks;
- .4 list of tanks with information on their use, corrosion prevention system and condition of coating;
- .5 conditions for survey (e.g. information regarding tank cleaning, gas freeing, ventilation, lighting, etc.);
- .6 provisions and methods for access to structures;
- .7 equipment for surveys;
- .8 identification of tanks and areas for close-up survey (see 2.4);
- .9 identification of areas and sections for thickness measurement (see 2.5);
- .10 identification of tanks for tank testing (see 2.6);
- .11 identification of the thickness measurement company;
- .12 damage experience related to the ship in question; and
- .13 critical structural areas and suspect areas, where relevant.

5.1.4 The Administration will advise the owner of the maximum acceptable structural corrosion diminution levels applicable to the ship.

5.1.5 Use may also be made of the Guidelines for technical assessment in conjunction with the planning of enhanced surveys for tankers, contained in annex 11. These Guidelines are a recommended tool which may be invoked at the discretion of the Administration, when considered necessary and appropriate, in conjunction with the preparation of the required survey programme.

5.2 *Conditions for survey*

5.2.1 The owner should provide the necessary facilities for a safe execution of the survey.

5.2.1.1 In order to enable the attending surveyors to carry out the survey, provisions for proper and safe access should be agreed between the owner and the Administration.

5.2.1.2 Details of the means of access should be provided in the survey planning questionnaire.

5.2.1.3 In cases where the provisions of safety and required access are judged by the attending surveyors not to be adequate, the survey of the spaces involved should not proceed.

5.2.2 Tanks and spaces should be safe for access. Tanks and spaces should be gas free and properly ventilated. Prior to entering a tank, void or enclosed space, it should be verified that the atmosphere in that space is free from hazardous gas and contains sufficient oxygen.

5.2.3 In preparation for survey and thickness measurements and to allow for a thorough examination, all spaces should be cleaned including removal from surfaces of all loose accumulated corrosion scale. Spaces should be sufficiently clean and free from water, scale, dirt, oil residues, etc., to reveal corrosion, deformation, fractures, damages or other structural deterioration as well as the condition of the coating. However, those areas of structure whose renewal has already been decided by the owner need only be cleaned and descaled to the extent necessary to determine the limits of the areas to be renewed.

5.2.4 Sufficient illumination should be provided to reveal corrosion, deformation, fractures, damages or other structural deterioration as well as the condition of the coating.

5.2.5 Where soft or semi-hard coatings have been applied, safe access should be provided for the surveyor to verify the effectiveness of the coating and to carry out an assessment of the conditions of internal structures which may include spot removal of the coating. When safe access cannot be provided, the soft or semi-hard coating should be removed.

5.2.6 The surveyor(s) should always be accompanied by at least one responsible person, assigned by the owner, experienced in tank and enclosed spaces inspection. In addition a backup team of at least two experienced persons should be stationed at the hatch opening of the tank or space that is being surveyed. The back-up team should continuously observe the work in the tank or space and should keep lifesaving and evacuation equipment ready for use.

5.2.7 A communication system should be arranged between the survey party in the tank or space being examined, the responsible officer on deck and, as the case may be, the navigation bridge. The communication arrangements should be maintained throughout the survey.

5.3 *Access to structures*¹⁰

5.3.1 For overall surveys, means should be provided to enable the surveyor to examine the structure in a safe and practical way.

5.3.2 For close-up surveys, one or more of the following means for access, acceptable to the surveyor, should be provided:

- .1 permanent staging and passages through structures;
- .2 temporary staging and passages through structures;

¹⁰ Refer to MSC/Circ.686, Guidelines on the means of access to structures for inspection and maintenance of oil tankers and bulk carriers.

- .3 lifts and moveable platforms;
- .4 boats or rafts;
- .5 portable ladders; and
- .6 other equivalent means.

5.4 *Equipment for survey*

5.4.1 Thickness measurement should normally be carried out by means of ultrasonic test equipment. The accuracy of the equipment should be proven to the surveyor as required.

5.4.2 One or more of the following fracture detection procedures may be required if deemed necessary by the surveyor:

- .1 radiographic equipment;
- .2 ultrasonic equipment;
- .3 magnetic particle equipment;
- .4 dye penetrant; and
- .5 other equivalent means.

5.4.3 Explosimeter, oxygen-meter, breathing apparatus, lifelines, riding belts with rope and hook and whistles together with instructions and guidance on their use should be made available during the survey. A safety checklist should be provided.

5.4.4 Adequate and safe lighting should be provided for the safe and efficient conduct of the survey.

5.4.5 Adequate protective clothing should be made available and used during the survey (e.g. safety helmet, gloves, safety shoes, etc.).

5.5 *Surveys at sea or at anchorage*

5.5.1 Surveys at sea or at anchorage may be accepted provided the surveyor(s) is given the necessary assistance from the personnel on board. Necessary precautions and procedures for carrying out the survey should be in accordance with 5.1, 5.2, 5.3 and 5.4.

5.5.2 A communication system should be arranged between the survey party in the tank and the responsible officer on deck. This system should also include the personnel in charge of ballast pump handling if boats or rafts are used.

5.5.3 Surveys of tanks by means of boats or rafts may only be undertaken with the agreement of the surveyor, who should take into account the safety arrangements provided, including weather forecasting and ship response under foreseeable conditions and provided the expected rise of water within the tank does not exceed 0.25 m.

5.5.4 When rafts or boats are used for close-up surveys, the following conditions should be observed:

- .1 only rough duty, inflatable rafts or boats, having satisfactory residual buoyancy and stability even if one chamber is ruptured, should be used;
- .2 the boat or raft should be tethered to the access ladder and an additional person should be stationed down the access ladder with a clear view of the boat or raft;
- .3 appropriate lifejackets should be available for all participants;
- .4 the surface of water in the tank should be calm (under all foreseeable conditions the expected rise of water within the tank should not exceed 0.25 m) and the water level stationary. On no account should the level of the water be rising while the boat or raft is in use;
- .5 the tank or space must contain clean ballast water only. Even a thin sheen of oil on the water is not acceptable;
- .6 at no time should the water level be allowed to be within 1 m of the deepest under-deck web face flat so that the survey team is not isolated from a direct escape route to the tank hatch. Filling to levels above the deck transverses should only be contemplated if a deck access manhole is fitted and open in the bay being examined, so that an escape route for the survey party is available at all times. Other effective means of escape to the deck may be considered; and
- .7 if the tanks (or spaces) are connected by a common venting system, or inert gas system, the tank in which the boat or raft should be used should be isolated to prevent a transfer of gas from other tanks (or spaces).

5.5.5 Rafts or boats alone may be allowed for inspection of the under deck areas of tanks or spaces if the depth of the webs is 1.5 m or less.

5.5.6 If the depth of the webs is more than 1.5 m, rafts or boats alone may be allowed only:

- .1 when the coating of the under-deck structure is in GOOD condition and there is no evidence of wastage; or
- .2 if a permanent means of access is provided in each bay to allow safe entry and exit. This means:
 - .1 access direct from the deck via a vertical ladder with a small platform fitted approximately 2 m below the deck in each bay; or
 - .2 access to deck from a longitudinal permanent platform having ladders to deck in each end of the tank. The platform should, for the full length of the tank, be arranged in level with, or above, the maximum water level needed for rafting of under deck structure. For this purpose, the ullage corresponding to the maximum water level should be assumed not more than 3 m from the deck plate measured at the midspan of deck transverses and in the middle length of the tank (see figure 1).

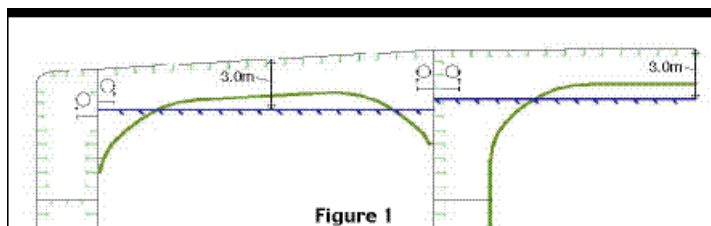

If neither of the above conditions are met, then staging or other equivalent means should be provided for the survey of the under-deck areas.

5.5.7 The use of rafts or boats alone in 5.5.5 and 5.5.6 does not preclude the use of boats or rafts to move about within a tank during a survey.

5.6 *Survey planning meeting*

5.6.1 Proper preparation and close cooperation between the attending surveyor(s) and the owner's representatives on board prior to and during the survey are an essential part in the safe and efficient conduct of the survey. During the survey on board safety meetings should be held regularly.

5.6.2 Prior to commencement of any part of the renewal and intermediate survey, a survey planning meeting should be held between the attending surveyor(s), the owner's representative in attendance, the thickness measurement company operator (as applicable) and the master of the ship or an appropriately qualified representative nominated by the master or company for the purpose of ascertaining that all the arrangements envisaged in the survey programme are in place, so as to ensure the safe and efficient conduct of the survey work to be carried out.

5.6.3 The following is an indicative list of items that should be addressed in the meeting:

- .1 schedule of the vessel (i.e. the voyage, docking and undocking manoeuvres, periods alongside, cargo and ballast operations, etc.);
- .2 provisions and arrangements for thickness measurements (i.e. access, cleaning/descaling, illumination, ventilation, personal safety);
- .3 extent of the thickness measurements;
- .4 acceptance criteria (refer to the list of minimum thicknesses);
- .5 extent of close-up survey and thickness measurement considering the coating condition and suspect areas/areas of substantial corrosion;
- .6 execution of thickness measurements;
- .7 taking representative readings in general and where uneven corrosion/pitting is found;
- .8 mapping of areas of substantial corrosion; and
- .9 communication between attending surveyor(s) the thickness measurement company operator(s) and owner representative(s) concerning findings.

6 Documentation on board

6.1 *General*

6.1.1 The owner should obtain, supply and maintain on board the ship, documentation as specified in 6.2 and 6.3 which should be readily available for the surveyor. The condition evaluation report referred to in 6.2 should include a translation into English.

6.1.2 The documentation should be kept on board for the lifetime of the ship.

6.2 *Survey report file*

6.2.1 A survey report file should be a part of the documentation on board consisting of:

- .1 reports of structural surveys (annex 8);
- .2 condition evaluation report (annex 9); and
- .3 thickness measurement reports (annex 10).

6.2.2 The survey report file should be available also in the owner's and the Administration's offices, or in the office of the organization recognized by the Administration.

6.3 *Supporting documents*

The following additional documentation should be available on board:

- .1 survey programme as required by 5.1 until such time as the renewal survey or intermediate survey, as applicable, has been completed;
- .2 main structural plans of cargo and ballast tanks;
- .3 previous repair history;
- .4 cargo and ballast history;
- .5 extent of use of inert gas plant and tank cleaning procedures;
- .6 inspections by ship's personnel with reference to:
 - .1 structural deterioration in general;
 - .2 leakage in bulkheads and piping; and
 - .3 condition of coating or corrosion prevention system, if any; and
- .7 any other information that would help to identify critical structural areas and/or suspect areas requiring inspection.

6.4 *Review of documentation on board*

Prior to survey, the surveyor should examine the completeness of the documentation on board and its contents as a basis for the survey.

7 Procedures for thickness measurements

7.1 *General*

7.1.1 The required thickness measurements, if not carried out by the recognized organization acting on behalf of the Administration, should be witnessed by a surveyor of the recognized organization. The surveyor should be on board to the extent necessary to control the process.

7.1.2 The thickness measurement company should be part of the survey planning meeting to be held prior to commencing the survey.

7.1.3 Thickness measurements of structures in areas where close-up surveys are required should be carried out simultaneously with close-up surveys.

7.1.4 In all cases the extent of the thickness measurements should be sufficient as to represent the actual average condition.

7.2 *Certification of thickness measurement company*

The thickness measurements should be carried out by a qualified company certified by an organization recognized by the Administration according to principles stated in annex 7.

7.3 *Reporting*

7.3.1 A thickness measurement report should be prepared and submitted to the Administration. The report should give the location of measurements, the thickness measured as well as corresponding original thickness. Furthermore, the report should give the date when the measurements were carried out, type of measuring equipment, names of personnel and their qualifications and be signed by the operator. The thickness measurement report should follow the principles as specified in the recommended procedures for thickness measurements set out in annex 10.

7.3.2 The surveyor should review the final thickness measurement report and countersign the cover page.

8 Reporting and evaluation of survey

8.1 *Evaluation of survey report*

8.1.1 The data and information on the structural condition of the ship collected during the survey should be evaluated for acceptability and continued structural integrity of the ship.

8.1.2 In case of oil tankers of 130 m in length and upwards (as defined in the International Convention on Load Lines in force), the ship's longitudinal strength should be evaluated by using the thickness of structural members measured, renewed and reinforced, as appropriate, during the renewal survey of safety construction carried out after the ship reached 10 years of age, in accordance with the criteria for longitudinal strength of the ship's hull girder for oil tankers specified in annex 12.

8.1.3 The analysis of data should be carried out and endorsed by the Administration or recognized organization authorized by the Administration and the conclusions of the analysis should form a part of the condition evaluation report.

8.1.4 The final result of the evaluation of the ship's longitudinal strength required in 8.1.2, after renewal or reinforcement work of structural members, if carried out as a result of initial evaluation, should be reported as a part of the condition evaluation report.

8.2 *Reporting*

8.2.1 Principles for survey reporting are shown in annex 8.

8.2.2 When a survey is split between different survey stations, a report should be made for each portion of the survey. A list of items examined and/or tested (pressure testing, thickness measurements, etc.) and an indication of whether the item has been credited, should be made available to the next attending surveyor(s), prior to continuing or completing the survey.

8.2.3 A condition evaluation report of the survey and results should be issued to the owner as shown in annex 9 and placed on board the ship for reference at future surveys. The condition evaluation report should be endorsed by the Administration or recognized organization authorized by the Administration.

ANNEX 1

MINIMUM REQUIREMENTS FOR CLOSE-UP SURVEY AT RENEWAL SURVEY OF DOUBLE-HULL OIL TANKERS

Age ≤ 5 years Renewal Survey No. 1	5 < Age ≤ 10 years Renewal Survey No. 2	10 < Age ≤ 15 years Renewal Survey No. 3	Age > 15 years Renewal Survey No. 4 and subsequent
One web frame (1), in a complete ballast tank (<i>see Note 1</i>)	All web frames (1), in a complete ballast tank (<i>see Note 1</i>) The knuckle area and the upper part (5 m approximately) of one web frame in each remaining ballast tank (6)	All web frames (1), in all ballast tanks	As for ships referred to in column 3 Additional transverse areas as deemed necessary by the Administration
One deck transverse, in a cargo oil tank (2)	One deck transverse, in two cargo oil tanks (2)	All web frames (7), including deck transverse and cross ties, if fitted, in a cargo oil tank One web frame (7), including deck transverse and cross ties, if fitted, in each remaining cargo oil tank All transverse bulkheads, in all cargo oil (3) and ballast (4) tanks	
One transverse bulkhead (4), in a complete ballast tank (<i>see Note 1</i>)	One transverse bulkhead (4), in each complete ballast tank (<i>see Note 1</i>)		
One transverse bulkhead (5) in a cargo oil centre tank One transverse bulkhead (5), in a cargo oil wing tank (<i>see Note 2</i>)	One transverse bulkhead (5), in two cargo oil centre tanks One transverse bulkhead (5), in a cargo oil wing tank (<i>see Note 2</i>)		

Notes:

(1), (2), (3), (4), (5), (6) and (7) are areas to be subjected to close-up surveys and thickness measurements (see appendix 3 of annex 10).

- (1) Web frame in a ballast tank means vertical web in side tank, hopper web in hopper tank, floor in double-bottom tank and deck transverse in double-deck tank (where fitted), including adjacent structural members. In fore and aft peak tanks web frame means a complete transverse web frame ring including adjacent structural members.
- (2) Deck transverse, including adjacent deck structural members (or external structure on deck in way of the tank, where applicable).
- (3) Transverse bulkhead complete in cargo tanks, including girder system, adjacent structural members (such as longitudinal bulkheads) and internal structure of lower and upper stools, where fitted.
- (4) Transverse bulkhead complete in ballast tanks, including girder system and adjacent structural members, such as longitudinal bulkheads, girders in double-bottom tanks, inner bottom plating, hopper side, connecting brackets.
- (5) Transverse bulkhead lower part in cargo tank, including girder system, adjacent structural members (such as longitudinal bulkheads) and internal structure of lower stool, where fitted.
- (6) The knuckle area and the upper part (5 m approximately), including adjacent structural members. Knuckle area is the area of the web frame around the connections of the slope hopper plating to the inner hull bulkhead and the inner bottom plating, up to 2 m from the corners both on the bulkhead and the double bottom.
- (7) Web frame in a cargo oil tank means deck transverse, longitudinal bulkhead vertical girder and cross ties, where fitted, including adjacent structural members.

Note 1: Complete ballast tank: means double-bottom tank plus double-side tank plus double-deck tank, as applicable, even if these tanks are separate.

Note 2: Where no centre cargo tanks are fitted (as in the case of centre longitudinal bulkhead), transverse bulkheads in wing tanks should be surveyed.

ANNEX 2

MINIMUM REQUIREMENTS FOR THICKNESS MEASUREMENTS AT RENEWAL SURVEY OF DOUBLE-HULL OIL TANKERS

Age ≤ 5 years	5 < Age ≤ 10 years	10 < Age ≤ 15 years	Age > 15 years
1	2	3	4
One section of deck plating for the full beam of the ship within the cargo area	Within the cargo area: - each deck plate - one transverse section	Within the cargo area: - each deck plate - two transverse sections (1) - all wind and water strakes	Within the cargo area: - each deck plate - three transverse sections (1) - each bottom plate
	Selected wind and water strakes outside the cargo area	Selected wind and water strakes outside the cargo area	All wind and water strakes in full length
Measurements, for general assessment and recording of corrosion pattern, of those structural members subject to close-up survey according to annex 1	Measurements, for general assessment and recording of corrosion pattern, of those structural members subject to close-up survey according to annex 1	Measurements, for general assessment and recording of corrosion pattern, of those structural members subject to close-up survey according to annex 1	Measurements, for general assessment and recording of corrosion pattern, of those structural members subject to close-up survey according to annex 1
Suspect areas	Suspect areas	Suspect areas	Suspect areas
(1): at least one section should be within 0.5L amidships.			

ANNEX 3

MINIMUM REQUIREMENTS FOR TANK TESTING AT RENEWAL SURVEY OF DOUBLE-HULL OIL TANKERS

Age ≤ 5 years	Age > 5 years	Age > 10 years
1	2	3
All ballast tank boundaries	All ballast tank boundaries	All ballast tank boundaries
Cargo tank boundaries facing ballast tanks, void spaces, pipe tunnels, representative fuel oil tanks, pump-rooms or cofferdams	Cargo tank boundaries facing ballast tanks, void spaces, pipe tunnels, representative fuel oil tanks, pump-rooms or cofferdams	Cargo tank boundaries facing ballast tanks, void spaces, pipe tunnels, representative fuel oil tanks, pump-rooms or cofferdams
	All cargo tank bulkheads which form the boundaries of segregated cargoes	All remaining cargo tank bulkheads

ANNEX 4/SHEET 1

REQUIREMENTS FOR EXTENT OF THICKNESS MEASUREMENTS AT AREAS OF SUBSTANTIAL CORROSION OF DOUBLE-HULL OIL TANKERS**Renewal survey of double-hull oil tankers**

Bottom, inner bottom and hopper structure		
Structural member	Extent of measurement	Pattern of measurement
Bottom, inner bottom and hopper structure plating	Minimum of three bays across double-bottom tank, including aft bay Measurements around and under all suction bell mouths	Five-point pattern for each panel between longitudinals and floors
Bottom, inner bottom and hopper structure longitudinals	Minimum of three longitudinals in each bay where bottom plating measured	Three measurements in line across flange and three measurements on vertical web
Bottom girders, including the watertight ones	At fore and aft watertight floors and in centre of tanks	Vertical line of single measurements on girder plating with one measurement between each panel stiffener, or a minimum of three measurements
Bottom floors, including the watertight ones	Three floors in bays where bottom plating measured, with measurements at both ends and middle	Five-point pattern over 2 m ² area
Hopper structure web frame ring	Three floors in bays where bottom plating measured	Five-point pattern over 1 m ² of plating. Single measurements on flange
Hopper structure transverse watertight bulkhead or swash bulkhead	- lower 1/3 of bulkhead	Five-point pattern over 1 m ² of plating
	- upper 2/3 of bulkhead	Five-point pattern over 2 m ² of plating
	- stiffeners (minimum of three)	For web, five-point pattern over span (two measurements across web at each end and one at centre of span). For flange, single measurements at each end and centre of span
Panel stiffening	Where applicable	Single measurements

ANNEX 4/SHEET 2

REQUIREMENTS FOR EXTENT OF THICKNESS MEASUREMENTS AT AREAS OF SUBSTANTIAL CORROSION OF DOUBLE-HULL OIL TANKERS**Renewal survey of double-hull oil tankers within the cargo area length**

Deck structure		
Structural member	Extent of measurement	Pattern of measurement
Deck plating	Two transverse bands across tank	Minimum of three measurements per plate per band
Deck longitudinals	Every third longitudinal in each of two bands with a minimum of one longitudinal	Three measurements in line vertically on webs and two measurements on flange (if fitted)
Deck girders and brackets (usually in cargo tanks only)	At fore and aft transverse bulkhead, bracket toes and in centre of tanks	Vertical line of single measurements on web plating with one measurement between each panel stiffener, or a minimum of three measurements. Two measurements across flange. Five-point pattern on girder/bulkhead brackets
Deck transverse webs	Minimum of two webs, with measurements at both ends and middle of span	Five-point pattern over 1 m ² area. Single measurements on flange
Vertical web and transverse bulkhead in wing ballast tank (2 m from deck)	Minimum of two webs, and both transverse bulkheads	Five-point pattern over 1 m ² area
Panel stiffening	Where applicable	Single measurements

ANNEX 4/SHEET 3

REQUIREMENTS FOR EXTENT OF THICKNESS MEASUREMENTS AT AREAS OF SUBSTANTIAL CORROSION OF DOUBLE-HULL OIL TANKERS**Renewal survey of double-hull oil tankers within the cargo area length**

Structure in wing ballast tanks		
Structural member	Extent of measurement	Pattern of measurement
Side shell and longitudinal bulkhead plating: - upper strake and strakes in way of horizontal girders - all other strakes	Plating between each pair of longitudinals in a minimum of three bays (along the tank) Plating between every third pair of longitudinals in same three bays	Single measurement Single measurement
Side shell and longitudinal bulkhead longitudinals on: - upper strake - all other strakes	Each longitudinal in same three bays Every third longitudinal in same three bays	Three measurements across web and one measurement on flange Three measurements across web and one measurement on flange
Longitudinals brackets	Minimum of three at top, middle and bottom of tank in same three bays	Five-point pattern over area of bracket
Vertical web and transverse bulkheads (excluding deckhead area): - strakes in way of horizontal girders - other strakes	Minimum of two webs and both transverse bulkheads Minimum of two webs and both transverse bulkheads	Five-point pattern over approximately 2 m ² area Two measurements between each pair of vertical stiffeners
Horizontal girders	Plating on each girder in a minimum of three bays	Two measurements between each pair of longitudinal girder stiffeners
Panel stiffening	Where applicable	Single measurements

ANNEX 4/SHEET 4

REQUIREMENTS FOR EXTENT OF THICKNESS MEASUREMENTS AT AREAS OF SUBSTANTIAL CORROSION OF DOUBLE-HULL OIL TANKERS**Renewal survey of double-hull oil tankers within the cargo area length**

Longitudinal bulkheads in cargo tanks		
Structural member	Extent of measurement	Pattern of measurement
Deckhead and bottom strakes, and strakes in way of the horizontal stringers of transverse bulkheads	Plating between each pair of longitudinals in a minimum of three bays	Single measurement
All other strakes	Plating between every third pair of longitudinals in same three bays	Single measurement
Longitudinals on deckhead and bottom strakes	Each longitudinal in same three bays	Three measurements across web and one measurement on flange
All other longitudinals	Every third longitudinal in same three bays	Three measurements across web and one measurement on flange
Longitudinals brackets	Minimum of three at top, middle and bottom of tank in same three bays	Five-point pattern over area of bracket
Web frames and cross ties	Three webs with minimum of three locations on each web, including in way of cross tie connections	Five-point pattern over approximately 2 m ² area of webs, plus single measurements on flanges of web frame and cross ties
Lower end brackets (opposite side of web frame)	Minimum of three brackets	Five-point pattern over approximately 2 m ² area of brackets, plus single measurements on bracket flanges

ANNEX 4/SHEET 5

REQUIREMENTS FOR EXTENT OF THICKNESS MEASUREMENTS AT AREAS OF SUBSTANTIAL CORROSION OF DOUBLE-HULL OIL TANKERS**Renewal survey of double-hull oil tankers within the cargo area length**

Transverse watertight and swash bulkheads in cargo tanks		
Structural member	Extent of measurement	Pattern of measurement
Upper and lower stool, where fitted	Transverse band within 25 mm of welded connection to inner bottom/deck plating Transverse band within 25 mm of welded connection to shelf plate	Five-point pattern between stiffeners over 1 m length
Deckhead and bottom strakes, and strakes in way of horizontal stringers	Plating between pair of stiffeners at three locations: approximately $\frac{1}{4}$, $\frac{1}{2}$ and $\frac{3}{4}$ width of tank	Five-point pattern between stiffeners over 1 m length
All other strakes	Plating between pair of stiffeners at middle location	Single measurement
Strakes in corrugated bulkheads	Plating for each change of scantling at centre of panel and at flange of fabricated connection	Five-point pattern over approximately 1 m ² of plating
Stiffeners	Minimum of three typical stiffeners	For web, five-point pattern over span between bracket connections (two measurements across web at each bracket connection and one at centre of span) For flange, single measurements at each bracket toe and at centre of span
Brackets	Minimum of three at top, middle and bottom of tank	Five-point pattern over area of bracket
Horizontal stringers	All stringers with measurements at both ends and middle	Five-point pattern over 1 m ² area, plus single measurements near bracket toes and on flanges

ANNEX 5

OWNER'S INSPECTION REPORT

Structural condition

Ship's name:							
For tank No:							
Grade of steel: deck: side:							
bottom: longitudinal bulkhead:							
Elements	Cracks	Buckles	Corrosion	Coating	Pitting	Modification/repair	Other condition
Deck:							
Bottom:							
Side:							
Longitudinal bulkhead:							
Transverse bulkhead:							
Repairs carried out due to:							
Thickness measurements carried out (dates):							
Results in general:							
Overdue surveys:							
Outstanding conditions of class:							
Comments:							
Date of inspection:							
Inspected by:							
Signature:							

ANNEX 6A

SURVEY PROGRAMME**Basic information and particulars**

Name of ship:
IMO number:
Flag State:
Port of registry:
Gross tonnage:
Deadweight (metric tonnes):
Length between perpendiculars (m):
Shipbuilder:
Hull number:
Recognized organization (RO):
RO ship identity:
Date of delivery of the ship:
Owner:
Thickness measurement company:

1 Preamble1.1 *Scope*

1.1.1 The present survey programme covers the minimum extent of overall surveys, close-up surveys, thickness measurements and pressure testing within the cargo area, ballast tanks, including fore and aft peak tanks, required by the Code.

1.1.2 The arrangements and safety aspects of the survey should be acceptable to the attending surveyor(s).

1.2 *Documentation*

All documents used in the development of the survey programme should be available on board during the survey as required by section 6.

2 Arrangement of tanks and spaces

This section of the survey programme should provide information (either in the form of plans or text) on the arrangement of tanks and spaces that fall within the scope of the survey.

3 List of tanks and spaces with information on their use, extent of coatings and corrosion prevention system

This section of the survey programme should indicate any changes relating to (and should update) the information on the use of the tanks of the ship, the extent of coatings and the corrosion protective system provided in the survey planning questionnaire.

4 Conditions for survey

This section of the survey programme should provide information on the conditions for survey, e.g. information regarding cargo hold and tank cleaning, gas freeing, ventilation, lighting, etc.

5 Provisions and method of access to structures

This section of the survey programme should indicate any changes relating to (and should update) the information on the provisions and methods of access to structures provided in the survey planning questionnaire.

6 List of equipment for survey

This section of the survey programme should identify and list the equipment that will be made available for carrying out the survey and the required thickness measurements.

7 Survey requirements

7.1 Overall survey

This section of the survey programme should identify and list the spaces that should undergo an overall survey for the ship in accordance with 2.4.1.

7.2 Close-up survey

This section of the survey programme should identify and list the hull structures that should undergo a close-up survey for the ship in accordance with 2.4.2.

8 Identification of tanks for tank testing

This section of the survey programme should identify and list the tanks that should undergo tank testing for the ship in accordance with 2.6.

9 Identification of areas and sections for thickness measurements

This section of the survey programme should identify and list the areas and sections where thickness measurements should be taken in accordance with 2.5.1.

10 Minimum thickness of hull structures

This section of the survey programme should specify the minimum thickness for hull structures of the ship that are subject to the Code (indicate either (a) or preferably (b), if such information is available):

- (a) Determined from the attached wastage allowance table and the original thickness to the hull structure plans of the ship;
- (b) Given in the following table(s):

Area or location	Original as-built thickness (mm)	Minimum thickness (mm)	Substantial corrosion thickness (mm)
Deck			
Plating			
Longitudinals			
Longitudinal girders			
Bottom			
Plating			
Longitudinals			
Longitudinal girders			
Ship side			
Plating			
Longitudinals			
Longitudinal girders			
Longitudinal bulkhead			
Plating			
Longitudinals			
Longitudinal girders			
Inner bottom			
Plating			
Longitudinals			
Longitudinal girders			
Transverse bulkheads			
Plating			
Stiffeners			
Transverse web frames, floors and stringers			
Plating			
Flanges			
Stiffeners			
Cross ties			
Flanges			
Webs			

Note: The wastage allowance tables should be attached to the survey programme.

11 Thickness measurement company

This section of the survey programme should identify changes, if any, relating to the information on the thickness measurement company provided in the survey planning questionnaire.

12 Damage experience related to the ship

This section of the survey programme should, using the tables provided below, provide details of the hull damages for at least the last three years in way of the cargo and ballast tanks and void spaces within the cargo area. These damages are subject to survey.

Hull damages sorted by location for this ship

Tank or space number or area	Possible cause, if known	Description of the damages	Location	Repair	Date of repair

**Hull damages for sister or similar ships
(if available) in the case of design related damage**

Tank or space number or area	Possible cause, if known	Description of the damages	Location	Repair	Date of repair

13 Areas identified with substantial corrosion from previous surveys

This section of the survey programme should identify and list the areas of substantial corrosion from previous surveys.

14 Critical structural areas and suspect areas

This section of the survey programme should identify and list the critical structural areas and the suspect areas, if such information is available.

15 Other relevant comments and information

This section of the survey programme should provide any other comments and information relevant to the survey.

Appendices

Appendix 1 – List of plans

Paragraph 5.1.3.2 requires that main structural plans of cargo and ballast tanks (scantling drawings), including information on regarding use of high tensile steel (HTS), to be available. This appendix of the survey programme should identify and list the main structural plans which form part of the survey programme.

Appendix 2 – Survey planning questionnaire

The survey planning questionnaire (annex 6B), which has been submitted by the owner, should be appended to the survey programme.

Appendix 3 – Other documentation

This part of the survey programme should identify and list any other documentation that forms part of the plan.

Prepared by the owner in cooperation with the Administration for compliance with 5.1.3.

Date:

(name and signature of authorized owner's representative)

Date:

(name and signature of authorized representative of the Administration)

ANNEX 6B

SURVEY PLANNING QUESTIONNAIRE

The following information will enable the owner in cooperation with the Administration to develop a survey programme complying with the requirements of the Code. It is essential that the owner provides, when completing the present questionnaire, up-to-date information. The present questionnaire, when completed, should provide all information and material required by the resolution.

Particulars

Ship's name:

IMO number:

Flag State:

Port of registry:

Owner:

Recognized organization (RO):

Gross tonnage:

Deadweight (metric tonnes):

Date of delivery:

Information on access provision for close-up surveys and thickness measurement

The owner should indicate, in the table below, the means of access to the structures subject to close-up survey and thickness measurement. A close-up survey is an examination where the details of structural components are within the close visual inspection range of the attending surveyor, i.e. normally within reach of hand.

Tank No.	Structure	C (Cargo)/B (Ballast)	Temporary staging	Rafts	Ladders	Direct access	Other means (please specify)
F.P.	Fore peak						
A.P.	Aft peak						
Wing tanks	Underdeck						
	Side shell						
	Bottom transverse						
	Longitudinal						
	Transverse						
Centre tanks	Under deck						
	Bottom transverse						
	Transverse						

History of cargo with H₂S content or heated cargo for the last three years together with indication as to whether cargo was heated and, where available, Material Safety Data Sheets (MSDS)¹¹

Owner's inspections

Using a format similar to that of the table below (which is given as an example), the owner should provide details of the results of their inspections for the last three years on all cargo and ballast tanks and void spaces within the cargo area, including peak tanks.

Tank No.	Corrosion protection (1)	Coating extent (2)	Coating condition (3)	Structural deterioration (4)	Tank damage history (5)
Cargo centre tanks					
Cargo wing tanks					
Slop					
Ballast tanks					
Aft peak					
Fore peak					
Miscellaneous spaces					

Note:

Indicate tanks which are used for oil/ballast.

- 1) HC = hard coating; SC = soft coating;
A = anodes; NP = no protection
- 2) U = upper part; M = middle part;
L = lower part; C = complete
- 3) G = good; F = fair; P = poor;
RC = recoated (during the last three years)
- 4) N = no findings recorded; Y = findings recorded,
description of findings should be attached to this questionnaire
- 5) DR = Damage & Repair; L = Leakages;
CV = Conversion (description to be attached to this questionnaire)

Name of owner's representative:

.....

Signature:.....

Date:

¹¹ Refer to resolution MSC.150(77) on Recommendation for material safety data sheets for MARPOL Annex I cargoes and marine fuel oils.

Reports of port State control inspections

List the reports of port State control inspections containing hull structural related deficiencies and relevant information on rectification of the deficiencies:

Safety management system

List non-conformities related to hull maintenance, including the associated corrective actions:

Name and address of the approved thickness measurement company

ANNEX 7

PROCEDURES FOR CERTIFICATION OF A COMPANY ENGAGED IN THICKNESS MEASUREMENT OF HULL STRUCTURES

1 Application

This guidance applies for certification of the company which intends to engage in the thickness measurement of hull structures of ships.

2 Procedures for certification

Submission of documents

2.1 The following documents should be submitted to an organization recognized by the Administration for approval:

- .1 outline of the company, e.g. organization and management structure;
- .2 experience of the company in thickness measurement of hull structures of ships;
- .3 technicians' careers, i.e. experience of technicians as thickness measurement operators, technical knowledge and experience of hull structure, etc. Operators should be qualified according to a recognized industrial non-destructive test (NDT) standard;
- .4 equipment used for thickness measurement such as ultrasonic testing machines and their maintenance/calibration procedures;
- .5 a guide for thickness measurement operators;
- .6 training programmes for technicians for thickness measurement; and
- .7 measurement record format in accordance with recommended procedures for thickness measurements (see annex 10). Recommended procedures for thickness measurements of double-hull oil tankers are contained in annex 2.

Auditing of the company

2.2 Upon satisfactory review of the documents submitted, the company should be audited in order to ascertain that the company is duly organized and managed in accordance with the documents submitted and is capable of conducting thickness measurement of the hull structure of ships.

2.3 Certification is conditional upon an on board demonstration of thickness measurement as well as satisfactory reporting.

3 Certification

3.1 Upon satisfactory results of both the audit of the company referred to in 2.2 and the demonstration tests referred to in 2.3, the Administration or organization recognized by the Administration should issue a certificate of approval as well as a notice to the effect that the thickness measurement operation system of the company has been certified.

3.2 Renewal/endorsement of the certificate should be carried out at intervals not exceeding three years by verification that original conditions are maintained.

4 Report of any alteration to the certified thickness measurement operation system

In case any alteration to the certified thickness measurement operation system of the company is made, such alteration should be immediately reported to the organization recognized by the Administration. A re-audit should be carried out where deemed necessary by the organization recognized by the Administration.

5 Withdrawal of certification

The certification may be withdrawn in the following cases:

- .1 where the measurements were improperly carried out or the results were improperly reported;
- .2 where the surveyor found any deficiencies in the approved thickness measurement operation system of the company; and
- .3 where the company failed to report any alteration referred to in 4 to the organization recognized by the Administration as required.

ANNEX 8

SURVEY REPORTING PRINCIPLES

As a principle, for oil tankers subject to the Code, the surveyor should include the following contents in his report for survey of hull structure and piping systems, as relevant for the survey.

1 General

1.1 A survey report should be generated in the following cases:

- .1 in connection with commencement, continuation and/or completion of periodical hull surveys, i.e. annual, intermediate and renewal surveys, as relevant;
- .2 when structural damages/defects have been found;
- .3 when repairs, renewals or modifications have been carried out; and
- .4 when condition of class (recommendation) has been imposed or deleted.

1.2 The reporting should provide:

- .1 evidence that prescribed surveys have been carried out in accordance with applicable requirements;
- .2 documentation of surveys carried out with findings, repairs carried out and condition of class (recommendation) imposed or deleted;
- .3 survey records, including actions taken, which should form an auditable documentary trail. Survey reports should be kept in the survey report file required to be on board;
- .4 information for planning of future surveys; and
- .5 information which may be used as input for maintenance of classification rules and instructions.

1.3 When a survey is split between different survey stations, a report should be made for each portion of the survey. A list of items surveyed, relevant findings and an indication of whether the item has been credited, should be made available to the next attending surveyor, prior to continuing or completing the survey. Thickness measurement and tank testing carried out should also be listed for the next surveyor.

2 Extent of the survey

2.1 Identification of compartments where an overall survey has been carried out.

2.2 Identification of locations, in each tank, where a close-up survey has been carried out, together with information of the means of access used.

2.3 Identification of locations, in each tank, where thickness measurement has been carried out.

Note: As a minimum, the identification of location of close-up survey and thickness measurement should include a confirmation with description of individual structural members corresponding to the extent of requirements stipulated in this part of annex B based on type of periodical survey and the ship's age.

Where only partial survey is required, i.e. one web frame ring/one deck transverse, the identification should include location within each ballast tank and cargo hold by reference to frame numbers.

2.4 For areas in tanks where protective coating is found to be in good condition and the extent of close-up survey and/or thickness measurement has been specially considered, structures subject to special consideration should be identified.

2.5 Identification of tanks subject to tank testing.

2.6 Identification of piping systems on deck, including crude oil washing (COW) piping, and ballast piping within cargo and ballast tanks, pipe tunnels, cofferdams and void spaces where:

- .1 examination including internal examination of piping with valves and fittings and thickness measurement, as relevant, has been carried out; and
- .2 operational test to working pressure has been carried out.

3 Result of survey

3.1 Type, extent and condition of protective coating in each tank, as relevant (rated GOOD, FAIR or POOR), including identification of tanks fitted with anodes.

3.2 Structural condition of each compartment with information on the following, as relevant:

- .1 Identification of findings, such as:
 - .1 corrosion with description of location, type and extent;
 - .2 areas with substantial corrosion;
 - .3 cracks/fractures with description of location and extent;
 - .4 buckling with description of location and extent; and
 - .5 indents with description of location and extent.
- .2 Identification of compartments where no structural damage/defects are found. The report may be supplemented by sketches/photographs.
- .3 Thickness measurement report should be verified and signed by the surveyor controlling the measurements on board.

- .4 Evaluation result of longitudinal strength of the hull girder of oil tankers of 130 m in length and upwards and over 10 years of age. The following data should be included, as relevant:
- .1 measured and as-built transverse sectional areas of deck and bottom flanges;
 - .2 diminution of transverse sectional areas of deck and bottom flanges; and
 - .3 details of renewals or reinforcements carried out, as relevant (see 4.2).

4 Actions taken with respect to findings

4.1 Whenever the attending surveyor is of the opinion that repairs are required, each item to be repaired should be identified in a numbered list. Whenever repairs are carried out, details of the repairs effected should be reported by making specific reference to relevant items in the numbered list.

4.2 Repairs carried out should be reported with identification of:

- .1 compartment;
- .2 structural member;
- .3 repair method (i.e. renewal or modification), including:
 - .1 steel grades and scantlings (if different from the original); and
 - .2 sketches/photographs, as appropriate;
- .4 repair extent; and
- .5 non-destructive tests (NDT).

4.3 For repairs not completed at the time of survey, condition of class/recommendation should be imposed with a specific time limit for the repairs. In order to provide correct and proper information to the surveyor attending for survey of the repairs, condition of class/recommendation should be sufficiently detailed with identification of each item to be repaired. For identification of extensive repairs, reference may be given to the survey report.

ANNEX 9

CONDITION EVALUATION REPORT

Issued upon completion of renewal survey

General particulars

Ship's name: Class/Administration identity number:
Previous class/Administration identity number(s):
IMO number:
Port of registry: National flag:
Previous national flag(s):
Deadweight (metric tonnes): Gross tonnage:
National:
ITC (1969):
Date of build: Classification notation:
Date of major conversion:
Type of conversion: Owner:
Previous owner(s):

1 The survey reports and documents listed below have been reviewed by the undersigned and found to be satisfactory.

2 A summary of the survey is attached herewith on sheet 2.

3 The renewal survey has been completed in accordance with the present Code on (date)

Condition evaluation report completed by	Name Signature	Title
Office	Date	
Condition evaluation report verified by	Name Signature	Title
Office	Date	

Attached reports and documents:

- 1)
- 2)
- 3)
- 4)
- 5)
- 6)

Contents of condition evaluation report

- | | | |
|---------|--|--|
| Part 1 | – General particulars: | - See front page |
| Part 2 | – Report review: | - Where and how survey was done |
| Part 3 | – Close-up survey: | - Extent (which tanks) |
| Part 4 | – Cargo and ballast piping system: | - Examined
- Operationally tested |
| Part 5 | – Thickness measurements: | - Reference to thickness measurement report
- Summary of where measured
- Separate form indicating the spaces with substantial corrosion, and corresponding: <ul style="list-style-type: none"> - thickness diminution - corrosion pattern |
| Part 6 | – Tank corrosion prevention system: | - Separate form indicating: <ul style="list-style-type: none"> - location of coating/anodes - condition of coating (if applicable) |
| Part 7 | – Repairs: | - Identification of tanks/areas |
| Part 8 | – Condition of class/flag State requirements: | |
| Part 9 | – Memoranda: | - Acceptable defects
- Any points of attention for future surveys, e.g. for suspect areas
- Extended annual/intermediate survey due to coating breakdown |
| Part 10 | – Evaluation results of the ship's longitudinal strength (for oil tankers of 130 m in length and upwards and over 10 years of age) | |
| Part 11 | – Conclusion: | - Statement on evaluation/ verification of survey report |

Extract of thickness measurements

Reference is made to the thickness measurement report:

Position of substantially corroded tanks/areas ¹ or areas with deep pitting ³	Thickness diminution [%]	Corrosion pattern ²	Remarks: (e.g. reference to attached sketches)

Notes:

- 1 Substantial corrosion, i.e. 75 to 100 per cent of acceptable margins wasted.
- 2 P = Pitting
C = Corrosion in general
- 3 Any bottom plating with a pitting intensity of 20 per cent or more, with wastage in the substantial corrosion range or having an average depth of pitting of $\frac{1}{3}$ or more of actual plate thickness should be noted.

Tank corrosion prevention system

Tank Nos. ¹	Tank corrosion prevention system ²	Coating condition ³	Remarks

Notes:

1 All segregated ballast tanks and combined cargo/ballast tanks should be listed.

2 C = Coating
NP = No protection

3 Coating condition according to the following standard:

GOOD condition with only minor spot rusting.

FAIR condition with local breakdown of coating at edges of stiffeners and weld connections and/or light rusting over 20 per cent or more of areas under consideration, but less than as defined for POOR condition.

POOR condition with general breakdown of coating over 20 per cent or more of areas or hard scale at 10 per cent or more of areas under consideration.

If coating condition less than GOOD is given, extended annual surveys should be introduced. This should be noted in part 9 of the Contents of condition evaluation report.

Evaluation result of longitudinal strength of the hull girder of oil tankers of 130 m in length and upwards and of over 10 years of age

(of sections 1, 2 and 3 below, only one applicable section should be completed)

1 This section applies to ships regardless of the date of construction: Transverse sectional areas of deck flange (deck plating and deck longitudinals) and bottom flange (bottom shell plating and bottom longitudinals) of the ship's hull girder have been calculated by using the thickness measured, renewed or reinforced, as appropriate, during the renewal survey of the Cargo Ship Safety Construction Certificate or the Cargo Ship Safety Certificate (SC renewal survey) most recently conducted after the ship reached 10 years of age, and found that the diminution of the transverse sectional area does not exceed 10 per cent of the as-built area, as shown in the following table:

Table 1 – Transverse sectional area of hull girder flange

		Measured	As-built	Diminution
Transverse section 1	Deck flange	cm ²	cm ²	cm ² (%)
	Bottom flange	cm ²	cm ²	cm ² (%)
Transverse section 2	Deck flange	cm ²	cm ²	cm ² (%)
	Bottom flange	cm ²	cm ²	cm ² (%)
Transverse section 3	Deck flange	cm ²	cm ²	cm ² (%)
	Bottom flange	cm ²	cm ²	cm ² (%)

2 This section applies to ships constructed on or after 1 July 2002: Section moduli of transverse section of the ship's hull girder have been calculated by using the thickness of structural members measured, renewed or reinforced, as appropriate, during the SC renewal survey most recently conducted after the ship reached 10 years of age in accordance with the provisions of paragraph 2.2.1.1 of annex 12, and are found to be within their diminution limits determined by the Administration, taking into account the recommendations adopted by the Organization¹², as shown in the following table:

Table 2 – Transverse section modulus of hull girder

		$Z_{act} (cm^3)^1$	$Z_{req} (cm^3)^2$	Remarks
Transverse section 1	Upper deck			
	Bottom			
Transverse section 2	Upper deck			
	Bottom			
Transverse section 3	Upper deck			
	Bottom			

Notes:

- 1 Z_{act} means the actual section moduli of the transverse section of the ship's hull girder calculated by using the thickness of structural members measured, renewed or reinforced, as appropriate, during the SC renewal survey, in accordance with the provisions of paragraph 2.2.1.1 of annex 12.
- 2 Z_{req} means the diminution limit of the longitudinal bending strength of ships, as calculated in accordance with the provisions of paragraph 2.2.1.1 of annex 12.

The calculation sheets for Z_{act} should be attached to this report.

3 This section applies to ships constructed before 1 July 2002: Section moduli of transverse sections of the ship's hull girder have been calculated by using the thickness of structural members measured, renewed or reinforced, as appropriate, during the SC renewal survey most recently conducted after the ship reached 10 years of age in accordance with the provisions of paragraph 2.2.1.2 of annex 12, and found to meet the criteria required by the Administration or the recognized classification society and that Z_{act} is not less than Z_{mc} (defined in note 2 below) as specified in appendix 2 to annex 12, as shown in the following table.

Describe the criteria for acceptance of the minimum section moduli of the ship's hull girder for ships in service required by the Administration or the recognized classification society.

¹² Refer to resolution MSC.108(73) on Recommendations on compliance with the requirements of paragraph 2.2.1.1 of annex 12 to annex B to resolution A.744(18).

Table 3 – Transverse section modulus of hull girder

		$Z_{act} (cm^3)^1$	$Z_{mc} (cm^3)^2$	Remarks
Transverse section 1	Upper deck			
	Bottom			
Transverse section 2	Upper deck			
	Bottom			
Transverse section 3	Upper deck			
	Bottom			

Notes:

- 1 As defined in note 1 of table 2.
- 2 Z_{mc} means the diminution limit of minimum section modulus calculated in accordance with the provisions of paragraph 2.2.1.2 of annex 12.

ANNEX 10

**RECOMMENDED PROCEDURES FOR THICKNESS MEASUREMENTS OF
DOUBLE-HULL OIL TANKERS**

General

- 1 These procedures should be used for recording thickness measurements as required by annexes 2 and 4.
- 2 Reporting forms TM1-DHT, TM2-DHT(i), TM2-DHT(ii), TM3-DHT, TM4-DHT, TM5-DHT and TM6-DHT, set out in appendix 2, should be used for recording thickness measurements and the maximum allowable diminution should be stated. The maximum allowable diminution could be stated in an attached document.
- 3 Appendix 3 contains guidance diagrams and notes relating to the reporting forms and the requirements for thickness measurement.
- 4 The reporting forms should, where appropriate, be supplemented by data presented on structural sketches.

Appendix 1

GENERAL PARTICULARS

Ship's name:
IMO number:
Class/Administration identity number:
Port of registry:
Gross tonnage:
Deadweight:
Date of build:
Classification society:

Name of company performing thickness measurement:
.....
Thickness measurement company certified by:
Certificate number:
Certificate valid from: to
Place of measurement:
First date of measurement:
Last date of measurement:
Renewal survey/intermediate survey¹³ due:
Details of measurement equipment:
Qualification of operator:
Report number: consisting of pages
Name of operator: Name of surveyor:
Signature of operator: Signature of surveyor:
Company official stamp: Administration:

Official stamp

¹³ Delete as appropriate.

Appendix 2

Report on thickness measurement of all deck plating, all bottom shell plating or side shell plating* (TM1-DHT)

Ship's name..... Class Identity No..... Report No..... IMO number.....

STRAKE POSITION																		
	PLATE POSITION	No. or letter	Orig. thk. mm	Forward reading						Aft reading						Mean diminution %		
				Gauged		Diminution P		Diminution S		Gauged		Diminution P		Diminution S		P	S	mm
				P	S	mm	%	mm	%	P	S	mm	%	mm	%			
12 th forward																		
11th																		
10th																		
9th																		
8th																		
7th																		
6th																		
5th																		
4th																		
3rd																		
2nd																		
1st																		
Amidships																		
1st aft																		
2nd																		
3rd																		
4th																		
5th																		
6th																		
7th																		
8th																		
9th																		
10th																		
11th																		
11th																		
12th																		

Operator's signature.....

Notes – see following page (* – delete as appropriate)

Notes to the report TM1-DHT:

- 1 This report should be used for recording the thickness measurement of:
 - .1 All strength deck plating within the cargo area.
 - .2 All keel, bottom shell plating and bilge plating within the cargo area.
 - .3 Side shell plating including selected wind and water strakes outside cargo area.
 - .4 All wind and water strakes within cargo area.
- 2 The strake position should be clearly indicated as follows:
 - .1 For strength deck indicate the number of the strake of plating inboard from the stringer plate.
 - .2 For bottom plating indicate the number of the strake of plating outboard from the keel plate.
 - .3 For side shell plating give number of the strake of plating below sheerstrake and letter as shown on shell expansion.
- 3 Measurements should be taken at the forward and aft areas of all and where plates cross ballast/cargo tank boundaries separate measurements for the area of plating in way of each type of tank should be recorded.
- 4 The single measurements recorded should represent the average of multiple measurements.
- 5 The maximum allowable diminution could be stated in an attached document.

Report on thickness measurement of shell and deck plating (one, two or three transverse sections) (TM2-DHT(i))

Ship's name..... Class Identity No..... Report No..... IMO number.....

STRENGTH DECK AND SHEERSTRAKE PLATING																											
STRAKE POSITION	FIRST TRANSVERSE SECTION AT FRAME NUMBER....								SECOND TRANSVERSE SECTION AT FRAME NUMBER....								THIRD TRANSVERSE SECTION AT FRAME NUMBER....										
	No. or letter	Orig. thk. mm	Max allow. dimin. mm	Gauged		Diminution P		Diminution S		No. or letter	Orig. thk. mm	Max allow. dimin. mm	Gauged		Diminution P		Diminution S		No. or letter	Orig. thk. mm	Max allow. dimin. mm	Gauged		Diminution P		Diminution S	
				P	S	mm	%	mm	%				P	S	mm	%	mm	%				P	S	mm	%	mm	%
Stringer plate																											
1st strake inboard																											
2nd																											
3rd																											
4th																											
5th																											
6th																											
7th																											
8th																											
9th																											
10th																											
11th																											
12th																											
13th																											
14th																											
centre strake																											
sheerstrake																											
TOPSIDE																											
TOTAL																											

Operator's signature.....

Notes – see following page

Notes to the report TM2-DHT(j):

- 1 This report form should be used for recording the thickness measurements of strength deck plating and sheerstrake plating transverse sections:

One, two or three sections within the cargo area comprising structural items (0), (1) and (2) as shown on the diagrams of typical transverse sections illustrated in appendix 3.
- 2 The topside area comprises deck plating, stringer plate and sheerstrake (including rounded gunwales).
- 3 The exact frame station of measurement should be stated.
- 4 The single measurements recorded should represent the average of multiple measurements.
- 5 The maximum allowable diminution could be stated in an attached document.

Report on thickness measurement of shell and deck plating (one, two or three transverse sections) (TM2-DHT(ii))

Ship's name..... Class Identity No..... Report No..... IMO number.....

SHELL PLATING																											
STRAKE POSITION	FIRST TRANSVERSE SECTION AT FRAME NUMBER....									SECOND TRANSVERSE SECTION AT FRAME NUMBER....									THIRD TRANSVERSE SECTION AT FRAME NUMBER....								
	No. or letter	Orig. thk.	Max allow. dimin.	Gauged		Diminution P		Diminution S		No. or letter	Orig. thk.	Max allow. dimin.	Gauged		Diminution P		Diminution S		No. or letter	Orig. thk.	Max allow. dimin.	Gauged		Diminution P		Diminution S	
				P	S	mm	%	mm	%				P	S	mm	%	mm	%				P	S	mm	%	mm	%
1st below sheerstrake																											
2nd																											
3rd																											
4th																											
5th																											
6th																											
7th																											
8th																											
9th																											
10th																											
11th																											
12th																											
13th																											
14th																											
15th																											
16th																											
17th																											
18th																											
19th																											
20th																											
keel strake																											
BOTTOM TOTAL																											

Operator's signature.....

Notes – see following page

Notes to the report TM2-DHT(ii):

1 This report form should be used for recording the thickness measurements of shell plating transverse sections:

One, two or three sections within the cargo area comprising structural items (3), (4) and (5) and (6) as shown on the diagrams of typical transverse sections illustrated in appendix 3.

2 The bottom area comprises keel, bottom and bilge plating.

3 The exact frame station of measurement should be stated.

4 The single measurements recorded should represent the average of multiple measurements.

5 The maximum allowable diminution could be stated in an attached document.

Report on thickness measurement of longitudinal members (one, two or three transverse sections) (TM3-DHT)

Ship's name..... Class Identity No..... Report No..... IMO number.....

STRUCTURAL MEMBER	FIRST TRANSVERSE SECTION AT FRAME NUMBER....								SECOND TRANSVERSE SECTION AT FRAME NUMBER....								THIRD TRANSVERSE SECTION AT FRAME NUMBER....										
	Item no.	Orig. thk. mm	Max allow. dimin. mm	Gauged		Diminution P		Diminution S		Item no.	Orig. thk. mm	Max allow. dimin. mm	Gauged		Diminution P		Diminution S		Item no.	Orig. thk. mm	Max allow. dimin. mm	Gauged		Diminution P		Diminution S	
				P	S	mm	%	mm	%				P	S	mm	%	mm	%				P	S	mm	%	mm	%

Operator's signature.....

Notes – see following page

Notes to the report TM3-DHT:

- 1 This report should be used for recording the thickness measurements of longitudinal members at transverse sections:

One, two or three sections within the cargo area comprising appropriate structural items (10) to (29) as shown on the diagrams of typical transverse sections illustrated in appendix 3.

- 2 The exact frame station of measurement should be stated.
- 3 The single measurements recorded should represent the average of multiple measurements.
- 4 The maximum allowable diminution could be stated in an attached document.

**Report on thickness measurement of transverse structural members (in the cargo oil and water ballast tanks within the cargo tank length)
(TM4-DHT)**

Ship's name..... Class Identity No..... Report No..... IMO number.....

TANK DESCRIPTION:									
LOCATION OF STRUCTURE:									
STRUCTURAL MEMBER	ITEM	Original thickness	Max. allow. dimin.	Gauged		Diminution P		Diminution S	
		mm	mm	P	S	mm	%	mm	%

Operator's signature.....

Notes – see following page

Notes to the report TM4-DHT:

- 1 This report should be used for recording the thickness measurements of transverse structural members, comprising appropriate structural items (30) to (36) as shown on diagrams of typical transverse sections illustrated in appendix 3.
- 2 Guidance for areas of measurement is indicated in appendix 3. The single measurements recorded should represent the average of multiple measurements.
- 3 The maximum allowable diminution could be stated in an attached document.

Notes to the report TM5-DHT:

- 1 This report should be used for recording the thickness measurement of W.T./O.T. transverse bulkheads.
- 2 Guidance for areas of measurement is indicated in appendix 3.
- 3 The single measurements recorded should represent the average of multiple measurements.
- 4 The maximum allowable diminution could be stated in an attached document.

Report on thickness measurement of miscellaneous structural members (TM6-DHT)

Ship's name..... IMO number..... Class Identity No..... Report No.....

STRUCTURAL MEMBER:								SKETCH	
LOCATION OF STRUCTURE:									
Description	Org. thk.	Max. allow. dimin.	Gauged		Diminution P		Diminution S		
	mm	mm	P	S	mm	%	mm	%	

Operator's signature.....

Notes – see following page

Notes to the report TM6-DHT:

- 1 This report should be used for recording the thickness measurement of miscellaneous structural members.
- 2 The single measurements recorded should represent the average of multiple measurements.
- 3 The maximum allowable diminution could be stated in an attached document.

Appendix 3

THICKNESS MEASUREMENT – DOUBLE-HULL OIL TANKERS

Typical transverse section of a double-hull oil tanker above 150,000 dwt with indication of longitudinal and transverse members.

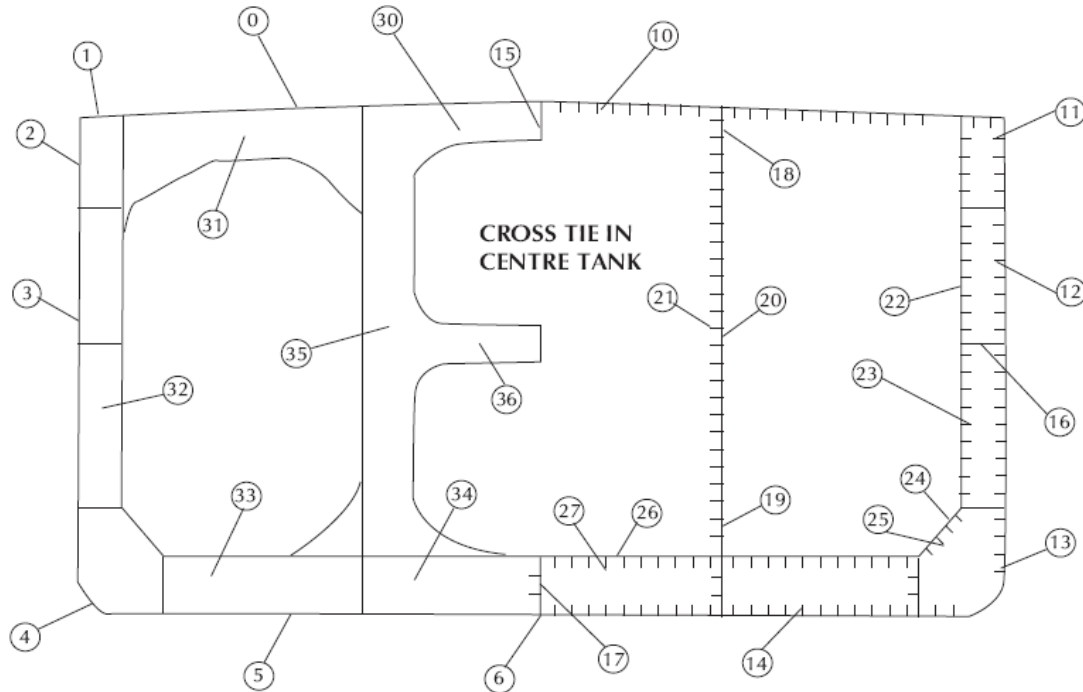

REPORT ON TM2-DHT(i) and (ii)	
0	Strength deck plating
1	Stringer plate
2	Sheerstrake
3	Side shell plating
4	Bilge plating
5	Bottom shell plating
6	Keel plate

REPORT ON TM3-DHT			
10	Deck longitudinals	20	Longitudinal bulkhead plating (remainder)
11	Sheerstrake longitudinals	21	Longitudinal bulkhead longitudinals
12	Side shell longitudinals	22	Inner side plating
13	Bilge longitudinals	23	Inner side longitudinals
14	Bottom longitudinals	24	Hopper plating
15	Deck girders	25	Hopper longitudinals
16	Horizontal girders in wing ballast tanks	26	Inner bottom plating
17	Bottom girders	27	Inner bottom longitudinals
18	Longitudinal bulkhead top strake	28	Topside tank plating
19	Longitudinal bulkhead bottom strake	29	Topside tank longitudinals

REPORT ON TM4-DHT	
30	Deck transverse – centre tank
31	Deck transverse – wing tank
32	Vertical web in wing ballast tank
33	Double bottom floor – wing tank
34	Double bottom floor – centre tank
35	Longitudinal bulkhead vertical web
36	Cross ties

THICKNESS MEASUREMENT – DOUBLE-HULL OIL TANKERS

Typical transverse section of a double-hull oil tanker up to 150,000 dwt with indication of longitudinal and transverse members.

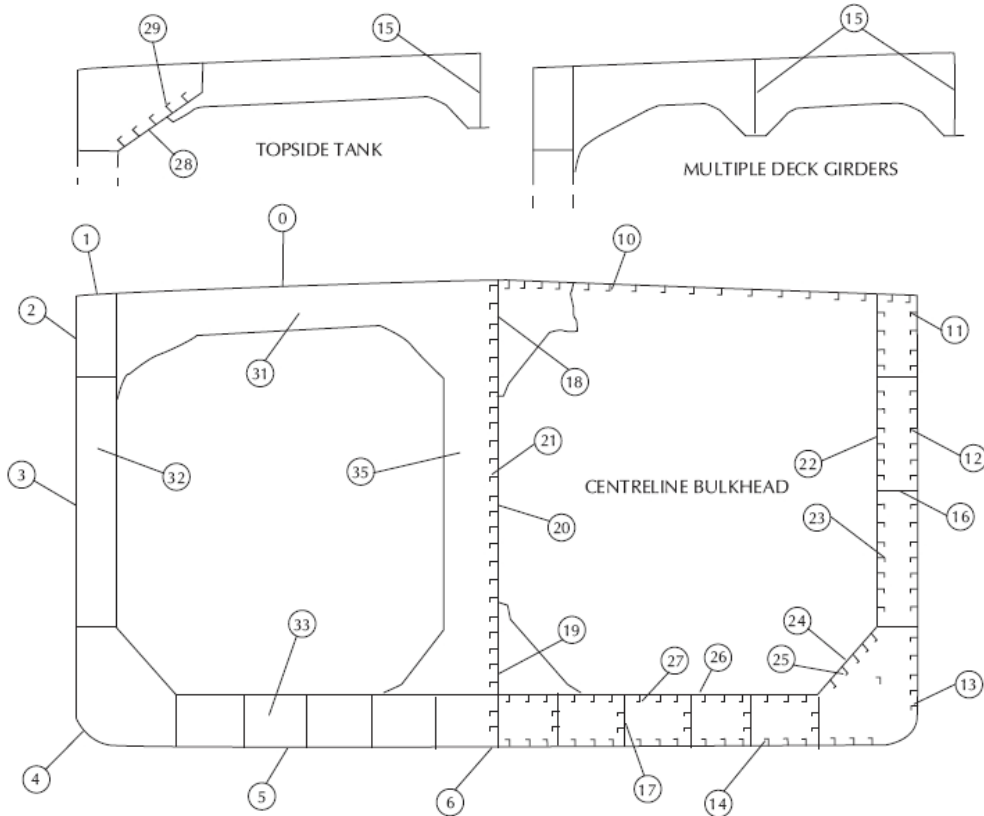

REPORT ON TM2-DHT(i) and (ii)	
0	Strength deck plating
1	Stringer plate
2	Sheerstrake
3	Side shell plating
4	Bilge plating
5	Bottom shell plating
6	Keel plate

REPORT ON TM3-DHT			
10	Deck longitudinals	20	Longitudinal bulkhead plating (remainder)
11	Sheerstrake longitudinals	21	Longitudinal bulkhead longitudinals
12	Side shell longitudinals	22	Inner side plating
13	Bilge longitudinals	23	Inner side longitudinals
14	Bottom longitudinals	24	Hopper plating
15	Deck girders	25	Hopper longitudinals
16	Horizontal girders in wing ballast tanks	26	Inner bottom plating
17	Bottom girders	27	Inner bottom longitudinals
18	Longitudinal bulkhead top strake	28	Topside tank plating
19	Longitudinal bulkhead bottom strake	29	Topside tank longitudinals

REPORT ON TM4-DHT	
30	Deck transverse – centre tank
31	Deck transverse – wing tank
32	Vertical web in wing ballast tank
33	Double bottom floor – wing tank
34	Double bottom floor – centre tank
35	Longitudinal bulkhead vertical web
36	Cross ties

THICKNESS MEASUREMENT – DOUBLE-HULL OIL TANKERS

Transverse section outline. The diagram may be used for those ships where typical sections are not applicable

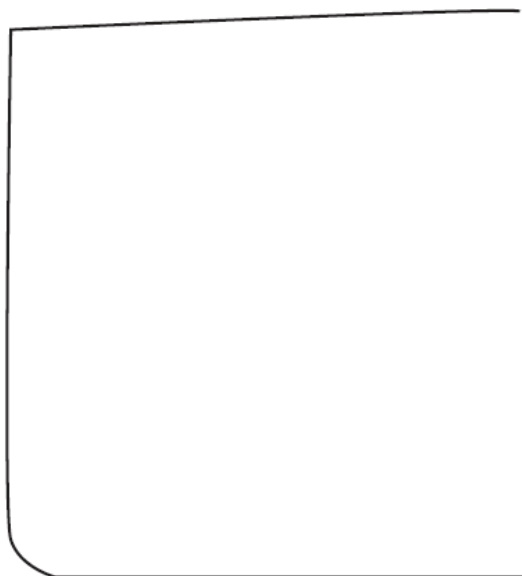

REPORT ON TM2-DHT(i) and (ii)	
①	Strength deck plating
②	Stringer plate
③	Sheerstrake
④	Side shell plating
⑤	Bilge plating
⑥	Bottom shell plating
⑦	Keel plate

REPORT ON TM3-DHT			
⑧	Deck longitudinals	⑩	Longitudinal bulkhead plating (remainder)
⑨	Sheerstrake longitudinals	⑪	Longitudinal bulkhead longitudinals
⑫	Side shell longitudinals	⑫	Inner side plating
⑬	Bilge longitudinals	⑬	Inner side longitudinals
⑭	Bottom longitudinals	⑭	Hopper plating
⑮	Deck girders	⑮	Hopper longitudinals
⑯	Horizontal girders in wing ballast tanks	⑯	Inner bottom plating
⑰	Bottom girders	⑰	Inner bottom longitudinals
⑱	Longitudinal bulkhead top strake	⑱	Topside tank plating
⑲	Longitudinal bulkhead bottom strake	⑲	Topside tank longitudinals

REPORT ON TM4-DHT	
⑳	Deck transverse – centre tank
㉑	Deck transverse – wing tank
㉒	Vertical web in wing ballast tank
㉓	Double bottom floor – wing tank
㉔	Double bottom floor – centre tank
㉕	Longitudinal bulkhead vertical web
㉖	Cross ties

THICKNESS MEASUREMENT – DOUBLE-HULL OIL TANKERS

Areas subject to close-up survey and thickness measurements – areas (1) to (5) as defined in annex 1 – Thickness to be reported on TM3-DHT, TM4-DHT and TM5-DHT as appropriate.

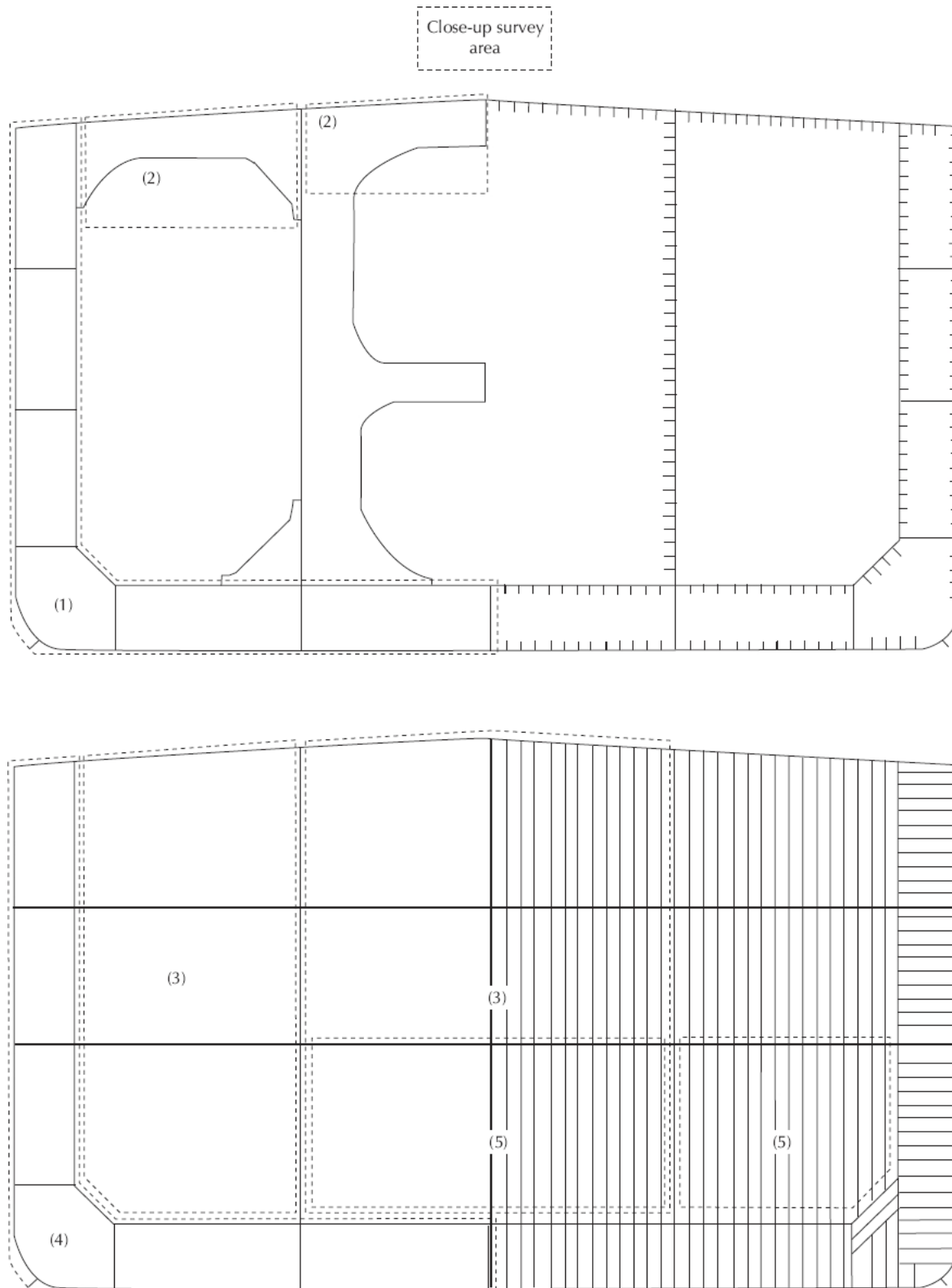

THICKNESS MEASUREMENT – DOUBLE-HULL OIL TANKERS

Areas subject to close-up survey and thickness measurements – areas (6) to (7) as defined in annex 1 – Thickness to be reported on TM3-DHT and TM4-DHT as appropriate.

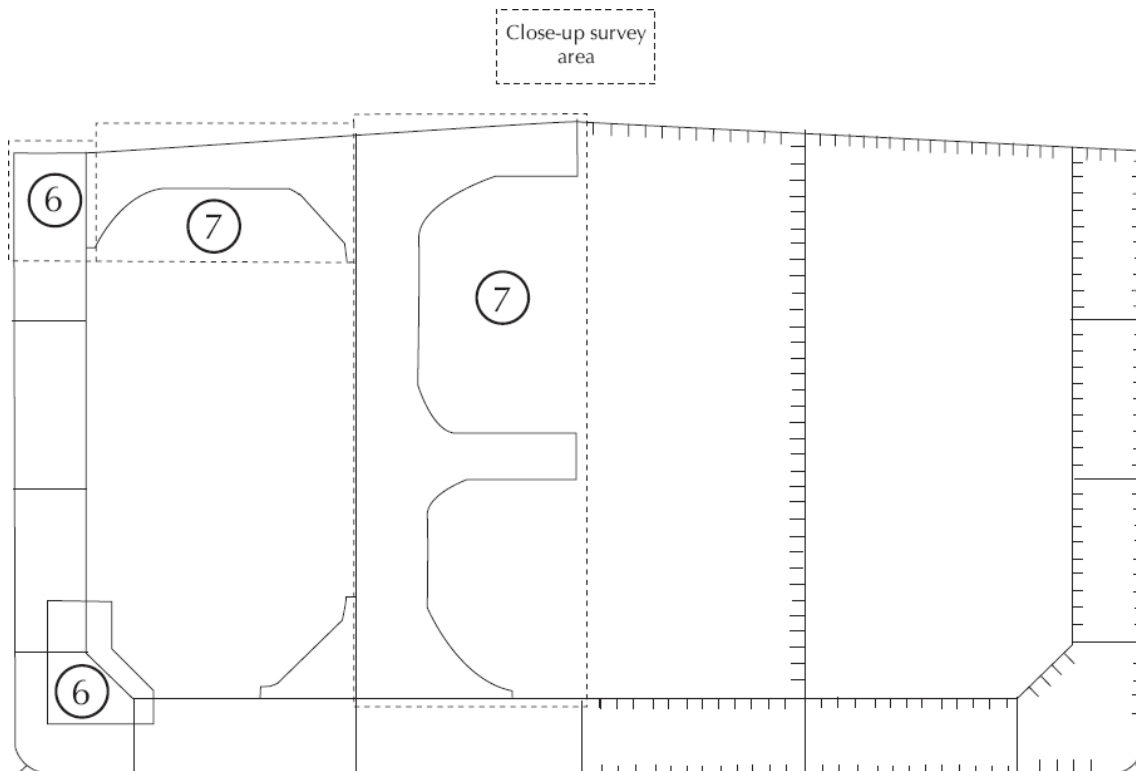

ANNEX 11

**GUIDELINES FOR TECHNICAL ASSESSMENT IN CONJUNCTION WITH
THE PLANNING OF ENHANCED SURVEYS FOR OIL TANKERS****Renewal survey****1 Introduction**

These Guidelines contain information and suggestions concerning technical assessments which may be of use in conjunction with the planning of renewal surveys of oil tankers. As indicated in 5.1.5, these Guidelines are a recommended tool which may be invoked at the discretion of an Administration, when considered necessary and appropriate, in conjunction with the preparation of the required survey programme.

2 Purpose and principles**2.1 Purpose**

The technical assessments described in these Guidelines should assist in identifying critical structural areas, nominating suspect areas and in focusing attention on structural elements or areas of structural elements which may be particularly susceptible to, or evidence a history of, wastage or damage. This information may be useful in nominating locations, areas and tanks for thickness measurement, close-up survey and tank testing.

2.2 Minimum requirements

These Guidelines may not be used to reduce the requirements of annexes 1, 2 and 3 for close-up survey, thickness measurement and tank testing, respectively, which are, in all cases, to be complied with as a minimum.

2.3 Timing

As with other aspects of survey planning, the technical assessments described in these Guidelines should be carried out by the owner or operator in cooperation with the Administration well in advance of the commencement of the renewal survey, i.e. prior to commencing the survey and normally at least 12 to 15 months before the survey's completion due date.

2.4 Aspects to be considered

Technical assessments, which may include quantitative or qualitative evaluation of relative risks of possible deterioration, of the following aspects of a particular ship may be used as a basis for the nomination of tanks and areas for survey of:

- .1 design features such as stress levels on various structural elements, design details and extent of use of high-tensile steel (HTS);
- .2 former history with respect to corrosion, cracking, buckling, indents and repairs for the particular ship as well as similar vessels, where available; and
- .3 information with respect to types of cargo carried, use of different tanks for cargo/ballast, protection of tanks and condition of coating, if any.

Technical assessments of the relative risks of susceptibility to damage or deterioration of various structural elements and areas should be judged and decided on the basis of recognized principles and practices, such as may be found in references 1 and 2.

3 Technical assessment

3.1 General

3.1.1 There are three basic types of possible failure which may be the subject of a technical assessment in connection with the planning of surveys: corrosion, cracks and buckling. Contact damages are not normally covered by the survey plan since indents are usually noted in memoranda and assumed to be dealt with as normal routine by surveyors.

3.1.2 Technical assessments performed in conjunction with the survey planning process should, in principle, be as shown schematically in figure 1 which depicts how technical assessments can be carried out in conjunction with the survey planning process. The approach is basically an evaluation of the risk, based on the knowledge and experience related to design and corrosion.

3.1.3 The design should be considered with respect to structural details which may be susceptible to buckling or cracking as a result of vibration, high stress levels or fatigue.

3.1.4 Corrosion is related to the ageing process and is closely connected with the quality of corrosion protection at newbuilding and subsequent maintenance during the service life. Corrosion may also lead to cracking and/or buckling.

3.2 Methods

3.2.1 Design details

3.2.1.1 Damage experience related to the ship in question and similar ships, where available, are the main source of information to be used in the process of planning. In addition, a selection of structural details from the design drawings should be included. Typical damage experience to be considered will consist of:

- .1 number, extent, location and frequency of cracks; and
- .2 location of buckles.

3.2.1.2 This information may be found in the survey reports and/or the owner's files, including the results of the owner's own inspections. The defects should be analysed, noted and marked on sketches.

3.2.1.3 In addition, general experience should be utilized. For example, reference should be made to reference 1, which contains a catalogue of typical damages and proposed repair methods for various tanker structural details.

3.2.1.4 Such figures should be used together with a review of the main drawings, in order to compare with the actual structure and search for similar details which may be susceptible to damage. An example is shown in figure 2. In particular, chapter 3 of reference 1 deals with various aspects specific to double-hull tankers, such as stress concentration locations, misalignment during construction, corrosion trends, fatigue considerations and areas requiring special attention, which should be considered in working out the survey planning.

3.2.1.5 The review of the main structural drawings, in addition to using the above-mentioned figures, should include checking for typical design details where cracking has been experienced. The factors contributing to damage should be carefully considered.

3.2.1.6 The use of HTS is an important factor. Details showing good service experience where ordinary, mild steel has been used may be more susceptible to damage when HTS, and its higher associated stresses, are utilized. There is extensive and, in general, good experience, with the use of HTS for longitudinal material in deck and bottom structures. Experience in other locations, where the dynamic stresses may be higher, is less favourable, e.g. side structures.

3.2.1.7 In this respect, stress calculations of typical and important components and details, in accordance with relevant methods, may prove useful and should be considered.

3.2.1.8 The selected areas of the structure identified during this process should be recorded and marked on the structural drawings to be included in the survey programme.

3.2.2 *Corrosion*

3.2.2.1 In order to evaluate relative corrosion risks, the following information is generally to be considered:

- .1 usage of tanks and spaces;
- .2 condition of coatings;
- .3 condition of anodes;
- .4 cleaning procedures;
- .5 previous corrosion damage;
- .6 ballast use and time for cargo tanks;
- .7 corrosion risk scheme (see reference 2, table 2.1); and
- .8 location of heated tanks.

3.2.2.2 Reference 2 gives definitive examples which can be used for judging and describing coating condition, using typical pictures of conditions.

3.2.2.3 The evaluation of corrosion risks should be based on information in reference 2, together with the age of the ship and relevant information on the anticipated condition as derived from the information collected in order to prepare the survey programme.

3.2.2.4 The various tanks and spaces should be listed with the corrosion risks nominated accordingly. Special attention should be given to the areas where the double-hull tanker is particularly exposed to corrosion. To this end, the specific aspects addressing corrosion in double-hull tankers indicated in 3.4 (Corrosion trends) of reference 1 should be taken into account.

3.2.3 *Locations for close-up survey and thickness measurement*

3.2.3.1 On the basis of the table of corrosion risks and the evaluation of design experience, the locations for initial close-up survey and thickness measurement (sections) may be nominated.

3.2.3.2 The sections subject to thickness measurement should normally be nominated in tanks and spaces where corrosion risk is judged to be the highest.

3.2.3.3 The nomination of tanks and spaces for close-up survey should, initially, be based on highest corrosion risk and should always include ballast tanks. The principle for the selection should be that the extent is increased by age or where information is insufficient or unreliable.

References

- 1 TSCF, Guidelines for the Inspection and Maintenance of Double Hull Tanker Structures, 1995.
- 2 TSCF, Guidance Manual for Tanker Structures, 1997.

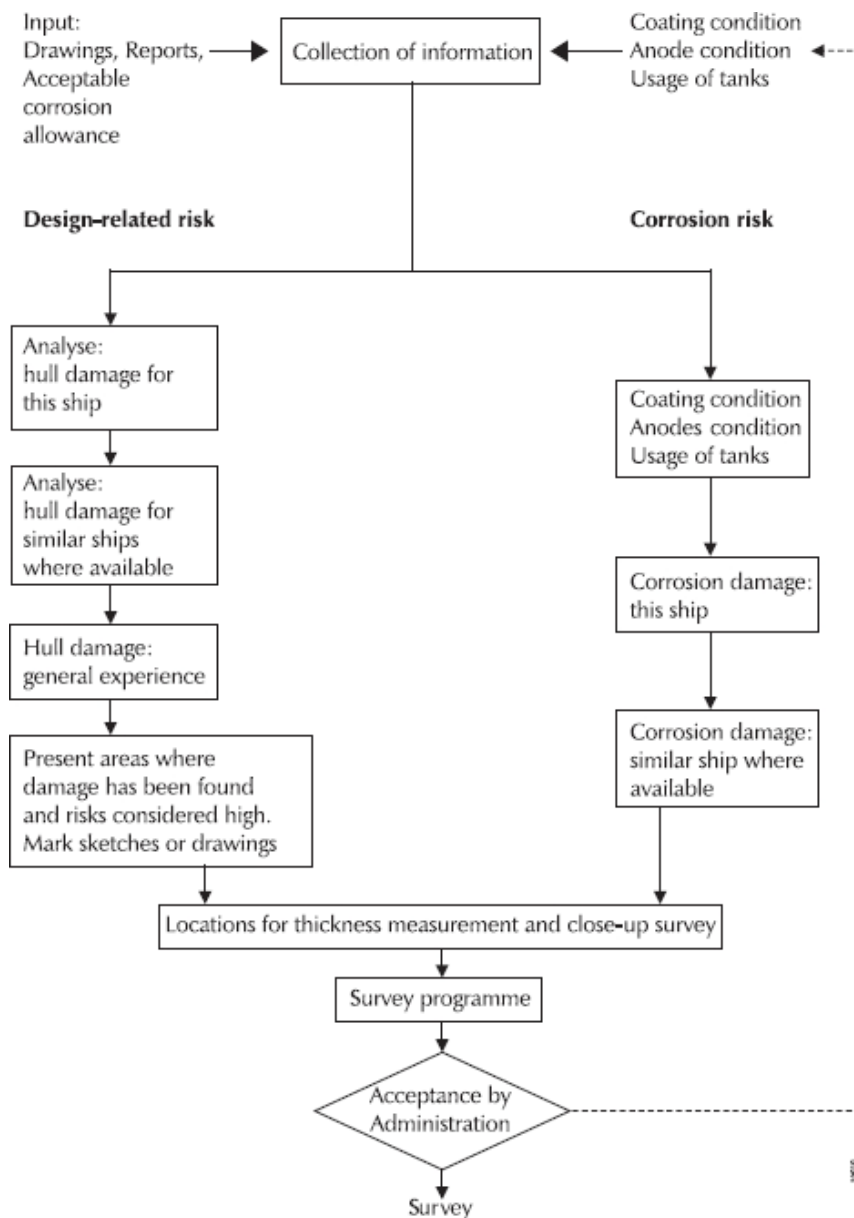

Figure 1 – Technical assessment and the survey planning process

LOCATION: Connection of longitudinals to transverse webs		
EXAMPLE NO. 1 Web and flat bar fractures at cut-outs for longitudinal stiffener connections		
TYPICAL DAMAGE	PROPOSED REPAIR	
<p style="text-align: center;">view A-A</p> <p style="text-align: center;">Note* one or more fractures may occur</p>	<p style="text-align: center;">full collar if fractures in web plate are small and are repaired by welding</p> <p style="text-align: center;">view A-A</p> <p style="text-align: center;"><i>web and flat bar cropped and part renewed or alternatively welded</i></p>	
<p>FACTORS CONTRIBUTING TO DAMAGE</p> <ol style="list-style-type: none"> 1 Asymmetrical connection of flat bar stiffener resulting in high peak stresses at the heel of the stiffener under fatigue loading. 2 Insufficient area of connection of longitudinal to web plate. 3 Defective weld at return around the plate thickness. 4 High localized corrosion at areas of stress concentration such as flat bar stiffener connections, corners of cut-out for the longitudinal and connection of web to shell at cut-outs. 5 High shear stress in the web of the transverse. 6 Dynamic seaway loads/ship motions. 		
FIGURE 1	TANKER STRUCTURE CO-OPERATIVE FORUM SUBJECT: CATALOGUE OF STRUCTURAL DETAILS	FIGURE 1

Figure 2 – Typical damage and repair example (reproduced from reference 2)

ANNEX 12

CRITERIA FOR LONGITUDINAL STRENGTH OF HULL GIRDER FOR OIL TANKERS**1 General**

1.1 These criteria should be used for the evaluation of the longitudinal strength of the ship's hull girder as required by 8.1.2.

1.2 In order that the ship's longitudinal strength to be evaluated can be recognized as valid, fillet welding between longitudinal internal members and hull envelopes should be in sound condition so as to keep the integrity of longitudinal internal members with hull envelopes.

2 Evaluation of longitudinal strength

On oil tankers of 130 m in length and upwards and over 10 years of age, the longitudinal strength of the ship's hull girder should be evaluated in compliance with the requirements of this annex on the basis of the thickness measured, renewed or reinforced, as appropriate, during the renewal survey of the Cargo Ship Safety Construction Certificate or Cargo Ship Safety Certificate (SC renewal survey). The condition of the hull girder for longitudinal strength evaluation should be determined in accordance with the methods specified in appendix 3.

2.1 Calculation of transverse sectional areas of deck and bottom flanges of hull girder

2.1.1 The transverse sectional areas of deck flange (deck plating and deck longitudinals) and bottom flange (bottom shell plating and bottom longitudinals) of the ship's hull girder should be calculated by using the thickness measured, renewed or reinforced, as appropriate, during the SC renewal survey.

2.1.2 If the diminution of sectional areas of either deck or bottom flange exceeds 10 per cent of their respective as-built area (i.e. original sectional area when the ship was built), either one of the following measures should be taken:

- .1 to renew or reinforce the deck or bottom flanges so that the actual sectional area is not less than 90 per cent of the as-built area; or
- .2 to calculate the actual section of moduli (Z_{act}) of transverse section of the ship's hull girder by applying the calculation method specified in appendix 1, by using the thickness measured, renewed or reinforced, as appropriate, during the SC renewal survey.

2.2 Requirements for transverse section modulus of hull girder

2.2.1 The actual section moduli of the transverse section of the ship's hull girder, calculated in accordance with 2.1.2.2, should satisfy either of the following provisions, as applicable:

- .1 for ships constructed on or after 1 July 2002, the actual section moduli (Z_{act}) of the transverse section of the ship's hull girder calculated in accordance with the requirements of paragraph 2.1.2.2 should be not less than the diminution limits determined by the Administration, taking into account the recommendations adopted by the Organization;¹⁴ or
- .2 for ships constructed before 1 July 2002, the actual section moduli (Z_{act}) of the transverse section of the ship's hull girder calculated in accordance with the requirements of 2.1.2.2 should meet the criteria for minimum section modulus for ships in service required by the Administration or recognized classification society, provided that in no case Z_{act} should be less than the diminution limit of the minimum section modulus (Z_{mc}) as specified in appendix 2.

¹⁴ Refer to resolution MSC.108(73) on Recommendation on compliance with the requirements of paragraph 2.2.1.1 of annex 12 to annex B to resolution A.744(18).

Appendix 1**CALCULATION CRITERIA OF SECTION MODULI
OF MIDSHIP SECTION OF HULL GIRDER**

1 When calculating the transverse section modulus of the ship's hull girder, the sectional area of all continuous longitudinal strength members should be taken into account.

2 Large openings, i.e. openings exceeding 2.5 m in length or 1.2 m in breadth, and scallops, where scallop welding is applied, are always to be deducted from the sectional areas used in the section modulus calculation.

3 Smaller openings (manholes, lightening holes, single scallops in way of seams, etc.) need not be deducted, provided that the sum of their breadths or shadow area breadths in one transverse section does not reduce the section modulus at deck or bottom by more than 3 per cent and provided that the height of lightening holes, draining holes and single scallops in longitudinals or longitudinal girders does not exceed 25 per cent of the web depth, for scallops maximum 75 mm.

4 A deduction-free sum of smaller opening breadths in one transverse section in the bottom or deck area of $0.06(B - \Sigma b)$ (where B = breadth of ship, Σb = total breadth of large openings) may be considered equivalent to the above reduction in sectional modulus.

5 The shadow area will be obtained by drawing two tangent lines with an opening angle of 30° .

6 The deck modulus is related to the moulded deck line at side.

7 The bottom modulus is related to the base line.

8 Continuous trunks and longitudinal hatch coamings should be included in the longitudinal sectional area provided they are effectively supported by longitudinal bulkheads or deep girders. The deck modulus is then to be calculated by dividing the moment of inertia by the following distance, provided this is greater than the distance to the deck line at side:

$$y_t = y \left(0.9 + 0.2 \frac{x}{B} \right)$$

where:

y = distance from neutral axis to top of continuous strength member;

x = distance from top of continuous strength member to centerline of the ship;

x and y to be measured to the point giving the largest value of y_t .

9 Longitudinal girders between multi-hatchways will be considered by special calculations.

Appendix 2

DIMINUTION LIMIT OF MINIMUM LONGITUDINAL STRENGTH OF SHIPS IN SERVICE

1 The diminution limit of the minimum section modulus (Z_{mc}) of oil tankers in service is given by the following formula:

$$Z_{mc} = cL^2B(C_b + 0.7)k \text{ (cm}^3\text{)}$$

where:

L = Length of ships. L is the distance, in metres, on the summer load waterline from the fore-side of stem to the after side of the rudder post, or the centre of the rudder stock if there is no rudder post. L is not to be less than 96 per cent, and need not be greater than 97 per cent, of the extreme length on the summer load waterline. In ships with unusual stern and bow arrangement, the length L may be specially considered.

B = Greatest moulded breadth in metres.

C_b = Moulded block coefficient at draught d corresponding to summer load waterline, based on L and B . C_b is not to be taken less than 0.6.

$$C_b = \frac{\text{moulded displacement (m}^3\text{) at draught } d}{LBd}$$

$$c = 0.9c_n$$

$$c_n = 10.75 - \left(\frac{300-L}{100}\right)^{1.5} \quad \text{for } 130 \text{ m} \leq L \leq 300 \text{ m}$$

$$c_n = 10.75 \quad \text{for } 300 \text{ m} \leq L \leq 350 \text{ m}$$

$$c_n = 10.75 - \left(\frac{L-350}{150}\right)^{1.5} \quad \text{for } 350 \text{ m} \leq L \leq 500 \text{ m}$$

k = material factor, e.g.

k = 1.0 for mild steel with yield stress of 235 N/mm² and over

k = 0.78 for high-tensile steel with yield stress of 315 N/mm² and over

k = 0.72 for high-tensile steel with yield stress of 355 N/mm² and over.

2 Scantlings of all continuous longitudinal members of the ship's hull girder based on the section modulus requirement in 1 above are to be maintained within 0.4 L amidships. However, in special cases, based on consideration of type of ship, hull form and loading conditions, the scantlings may be gradually reduced towards the end of 0.4 L part, bearing in mind the desire not to inhibit the ship's loading flexibility.

3 However, the above standard may not be applicable to ships of unusual type or design, e.g. for ships of unusual main proportions and/or weight distributions.

Appendix 3

SAMPLING METHOD OF THICKNESS MEASUREMENTS FOR LONGITUDINAL STRENGTH EVALUATION AND REPAIR METHODS

1 Extent of longitudinal strength evaluation

Longitudinal strength should be evaluated within $0.4L$ amidships for the extent of the hull girder length that contains tanks therein and within $0.5L$ amidships for adjacent tanks which may extend beyond $0.4L$ amidships, where tanks means ballast tanks and cargo tanks.

2 Sampling method of thickness measurement

2.1 Pursuant to the requirements of section 2.5, transverse sections should be chosen such that thickness measurements can be taken for as many different tanks in corrosive environments as possible, e.g. ballast tanks sharing a common plane boundary with cargo tanks fitted with heating coils, other ballast tanks, cargo tanks permitted to be filled with seawater and other cargo tanks. Ballast tanks sharing a common plane boundary with cargo tanks fitted with heating coils and cargo tanks permitted to be filled with seawater should be selected where present.

2.2 The minimum number of transverse sections to be sampled should be in accordance with annex 2. The transverse sections should be located where the largest thickness reductions are suspected to occur or are revealed from deck and bottom plating measurements prescribed in 2.3 and should be clear of areas which have been locally renewed or reinforced.

2.3 At least two points should be measured on each deck plate and/or bottom shell plate required to be measured within the cargo area in accordance with the requirements of annex 2.

2.4 Within $0.1D$ (where D is the ship's moulded depth) of the deck and bottom at each transverse section to be measured in accordance with the requirements of annex 2, every longitudinal and girder should be measured on the web and face plate, and every plate should be measured at one point between longitudinals.

2.5 For longitudinal members other than those specified in 2.4 to be measured at each transverse section in accordance with the requirements of annex 2, every longitudinal and girder should be measured on the web and face plate, and every plate should be measured at least in one point per strake.

2.6 The thickness of each component should be determined by averaging all of the measurements taken in way of the transverse section on each component.

3 Additional measurements where the longitudinal strength is deficient

3.1 Where one or more of the transverse sections are found to be deficient in respect of the longitudinal strength requirements given in this annex, the number of transverse sections for thickness measurement should be increased such that each tank within the $0.5L$ amidships region has been sampled. Tank spaces that are partially within, but extend beyond, the $0.5L$ region, should be sampled.

3.2 Additional thickness measurements should also be performed on one transverse section forward and one aft of each repaired area to the extent necessary to ensure that the areas bordering the repaired section also comply with the requirements of the Code.

4 Effective repair methods

4.1 The extent of renewal or reinforcement carried out to comply with this annex should be in accordance with 4.2.

4.2 The minimum continuous length of a renewed or reinforced structural member should be not less than twice the spacing of the primary members in way. In addition, the thickness diminution in way of the butt joint of each joining member forward and aft of the replaced member (plates, stiffeners, girder webs and flanges, etc.) should not be within the substantial corrosion range (75% of the allowable diminution associated with each particular member). Where differences in thickness at the butt joint exceed 15 per cent of the lower thickness, a transition taper should be provided.

4.3 Alternative repair methods involving the fitting of straps or structural member modification should be subject to special consideration. In considering the fitting of straps, it should be limited to the following conditions:

- .1 to restore and/or increase longitudinal strength;
- .2 the thickness diminution of the deck or bottom plating to be reinforced should not be within the substantial corrosion range (75% of the allowable diminution associated with the deck plating);
- .3 the alignment and arrangement, including the termination of the straps, is in accordance with a standard recognized by the Administration;
- .4 the straps are continuous over the entire $0.5L$ amidships length; and
- .5 continuous fillet welding and full penetration welds are used at butt welding and, depending on the width of the strap, slot welds. The welding procedures applied should be acceptable to the Administration.

4.4 The existing structure adjacent to replacement areas and in conjunction with the fitted straps, etc., should be capable of withstanding the applied loads, taking into account the buckling resistance and the condition of welds between the longitudinal members and hull envelope plating.

Part B

CODE ON THE ENHANCED PROGRAMME OF INSPECTIONS DURING SURVEYS OF OIL TANKERS OTHER THAN DOUBLE-HULL OIL TANKERS**1 General**1.1 *Application*¹⁵

1.1.1 The Code should apply to self-propelled oil tankers of 500 gross tonnage and above other than double-hull oil tankers, as defined in 1.2.1 of part A of annex B.

1.1.2 The Code should apply to surveys of hull structure and piping systems in way of cargo tanks, pump-rooms, cofferdams, pipe tunnels, void spaces within the cargo area and all ballast tanks.

1.1.3 The Code contains the minimum extent of examination, thickness measurements and tank pressure testing. The survey should be extended when substantial corrosion and/or structural defects are found and include additional close-up survey when necessary.

1.1.4 The surveys should be carried out during the surveys prescribed by regulation I/10 of the Convention.

1.2 *Definitions*

1.2.1 *Ballast tank* is a tank which is used solely for the carriage of salt water ballast.

1.2.2 *Combined cargo/ballast tank*, if referred to within the Code, is a tank which is used for the carriage of cargo or ballast water as a routine part of the ship's operation and will be treated as a ballast tank. Cargo tanks in which water ballast might be carried only in exceptional cases per MARPOL regulation I/18.3 are to be treated as cargo tanks.

1.2.3 *Overall survey* is a survey intended to report on the overall condition of the hull structure and determine the extent of additional close-up surveys.

1.2.4 *Close-up survey* is a survey where the details of structural components are within the close visual inspection range of the surveyor, i.e. normally within reach of hand.

1.2.5 *Transverse section* is the cross section of the hull perpendicular to the ship's centerline and includes all longitudinal members such as plating, longitudinals and girders at the deck, sides, bottom, inner bottom and longitudinal bulkheads.

1.2.6 *Representative tanks* are those which are expected to reflect the condition of other tanks of similar type and service and with similar corrosion prevention systems. When selecting representative tanks, account should be taken of the service and repair history on board and identifiable critical and/or suspect areas.

¹⁵ The intention of the Code is to ensure that an appropriate level of review of plans and documents is conducted and consistency in application is attained. Such evaluation of survey reports, survey programmes, planning documents, etc., should be carried out at the managerial level of the Administration or organization recognized by the Administration.

1.2.7 *Suspect areas* are locations showing substantial corrosion and/or are considered by the surveyor to be prone to rapid wastage.

1.2.8 *Substantial corrosion* is an extent of corrosion such that assessment of corrosion pattern indicates a wastage in excess of 75 per cent of allowable margins, but within acceptable limits.

1.2.9 *Corrosion prevention system* is normally considered a full hard protective coating. Hard protective coating should usually be epoxy coating or equivalent. Other coating systems, which are neither soft nor semi-hard coatings, may be considered acceptable as alternatives provided that they are applied and maintained in compliance with the manufacturer's specifications.

1.2.10 *Coating condition* is defined as follows:

GOOD condition with only minor spot rusting;

FAIR condition with local breakdown of coating at edges of stiffeners and weld connections and/or light rusting over 20 per cent or more of areas under consideration, but less than as defined for POOR condition;

POOR condition with general breakdown of coating over 20 per cent or more of areas or hard scale at 10 per cent or more of areas under consideration.

1.2.11 *Critical structural areas* are locations which have been identified from calculations to require monitoring or from the service history of the subject ship or from similar or sister ships to be sensitive to cracking, buckling or corrosion which would impair the structural integrity of the ship.

1.2.12 *Cargo area* is that part of the ship which contains cargo tanks, slop tanks and cargo/ballast pump-rooms, cofferdams, ballast tanks and void spaces adjacent to cargo tanks and also deck areas throughout the entire length and breadth of the part of the ship over the above-mentioned spaces.

1.2.13 *Intermediate survey* is a survey carried out either at the second or third annual survey.

1.2.14 *Prompt and thorough repair* is a permanent repair completed at the time of survey to the satisfaction of the surveyor, therein removing the need for the imposition of any associated condition of classification or recommendation.

1.2.15 *Specially considered* (in connection with close-up surveys and thickness measurements) means sufficient close-up inspection and thickness measurements are taken to confirm the actual average condition of the structure under coating.

1.3 *Repairs*

1.3.1 Any damage in association with wastage over the allowable limits (including buckling, grooving, detachment or fracture), or extensive areas of wastage over the allowable limits, which affects or, in the opinion of the Administration, will affect the ship's structural, watertight or weathertight integrity, should be promptly and thoroughly repaired. Areas to be considered include:

- .1 side shell frames, their end attachments or adjacent shell plating;
- .2 deck structure and deck plating;
- .3 bottom structure and bottom plating;
- .4 watertight or oiltight bulkheads; and
- .5 hatch covers and hatch coamings where fitted to combination carriers.

Where adequate repair facilities are not available, the Administration may allow the ship to proceed directly to a repair facility. This may require discharging the cargo and/or temporary repairs for the intended voyage.

1.3.2 Additionally, when a survey results in the identification of corrosion or structural defects, either of which, in the opinion of the Administration, will impair the ship's fitness for continued service, remedial measures should be implemented before the ship continues in service.

1.4 *Surveyors*

For tankers of 20,000 tons deadweight and above, two surveyors should jointly carry out the first scheduled renewal survey after the tanker passes 10 years of age (i.e. third renewal survey), and all subsequent renewal surveys and intermediate surveys. If the surveys are carried out by a recognized organization, the surveyors should be exclusively employed by such recognized organizations.

1.5 *Thickness measurements and close-up surveys*

In any kind of survey, i.e. renewal, intermediate, annual or other surveys having the scope of the foregoing ones, thickness measurements of structures in areas where close-up surveys are required should be carried out simultaneously with close-up surveys.

2 Renewal survey

2.1 *General*

2.1.1 The renewal survey may be commenced at the fourth annual survey and be progressed during the succeeding year with a view to completion by the fifth anniversary date.

2.1.2 As part of the preparation for the renewal survey, the survey programme should be dealt with, in advance of the renewal survey. The thickness measurement should not be held before the fourth annual survey.

2.1.3 The survey should include, in addition to the requirements of the annual survey, examination, tests and checks of sufficient extent to ensure that the hull and related piping as required in 2.1.5 is in a satisfactory condition and is fit for its intended purpose for the new period of validity of the Cargo Ship Safety Construction Certificate, subject to proper maintenance and operation and to periodical surveys being carried out at the due dates.

2.1.4 All cargo tanks, ballast tanks, and any other tanks within the cargo areas which are forming hull structures, pump-rooms, pipe tunnels, cofferdams and void spaces bounding cargo tanks, decks and outer hull should be examined, and this examination should be

supplemented by thickness measurement and testing as required in 2.5 and 2.6, to ensure that the structural integrity remains effective. The aim of the examination is to discover substantial corrosion, significant deformation, fractures, damages or other structural deterioration that may be present.

2.1.5 Cargo piping on deck, including crude oil washing (COW) piping, and cargo and ballast piping within the above tanks and spaces should be examined and operationally tested to working pressure to attending surveyor's satisfaction to ensure that tightness and condition remain satisfactory. Special attention should be given to any ballast piping in cargo tanks and any cargo piping in any ballast tanks and void spaces, and surveyors should be advised on all occasions when this piping, including valves and fittings, are open during repair periods and can be examined internally.

2.1.6 The survey extent of combined ballast/cargo tanks should be evaluated based on the records of ballast history and extent of the corrosion prevention system provided.

2.2 *Dry-dock survey*

2.2.1 A survey in dry-dock should be a part of the renewal survey. There should be a minimum of two inspections of the outside of the ship's bottom during the five-year period of the Cargo Ship Safety Construction Certificate. In all cases, the maximum interval between bottom inspections should not exceed 36 months.

2.2.2 For ships of 15 years of age and over, inspection of the outside of the ship's bottom should be carried out with the ship in dry-dock. For ships of less than 15 years of age, alternate inspections of the ship's bottom not conducted in conjunction with the renewal survey may be carried out with the ship afloat. Inspection of the ship afloat should only be carried out when the conditions are satisfactory and the proper equipment and suitably qualified staff is available.

2.2.3 If a survey in dry-dock is not completed in conjunction with the renewal survey or if the 36 month maximum interval referred to in 2.2.1 is not complied with, the Cargo Ship Safety Construction Certificate should cease to be valid until a survey in dry-dock is completed.

2.2.4 The overall and close-up surveys and thickness measurements, as applicable, of the lower portions of the cargo tanks and ballast tanks should be carried out in accordance with the applicable requirements for renewal surveys, if not already performed.

Note: Lower portions of the cargo and ballast tanks are considered to be the parts below light ballast water line.

2.3 *Tank corrosion prevention system*

Where provided, the condition of the corrosion prevention system of cargo tanks should be examined. A ballast tank should be examined at annual intervals where:

- .1 a hard protective coating has not been applied from the time of construction; or
- .2 a soft or semi-hard coating has been applied; or
- .3 substantial corrosion is found within the tank; or

- .4 the hard protective coating is found to be in less than GOOD condition and the hard protective coating is not repaired to the satisfaction of the surveyor.

Thickness measurements should be carried out as deemed necessary by the surveyor.

2.4 *Extent of overall and close-up surveys*

2.4.1 An overall survey of all tanks and spaces should be carried out at the renewal survey. Suspect areas identified at previous surveys should be examined.

2.4.2 The minimum requirements for close-up surveys at the renewal survey are given in annex 1.

2.4.3 The surveyor may extend the scope of the close-up survey as deemed necessary taking into account the maintenance of the tanks under survey, the condition of the corrosion prevention system and also in the following cases:

- .1 in particular, tanks having structural arrangements or details which have suffered defects in similar tanks or on similar ships according to available information; and
- .2 in tanks which have structures with reduced scantlings in association with a corrosion prevention system approved by the Administration.

2.4.4 For areas in tanks where hard protective coatings are found to be in GOOD condition as defined in 1.2.10, the extent of close-up surveys according to annex 1 may be specially considered by the Administration.

2.5 *Extent of thickness measurements*

2.5.1 The minimum requirements for thickness measurements at the renewal survey are given in annex 2.

2.5.2 Provisions for extended measurements for areas with substantial corrosion are given in annex 4, and as may be additionally specified in the survey programme as required in 5.1. These extended thickness measurements should be carried out before the survey is credited as completed. Suspect areas identified at previous surveys should have thickness measurements taken.

2.5.3 The surveyor may further extend the thickness measurements as deemed necessary.

2.5.4 For areas in tanks where hard protective coatings are found to be in GOOD condition as defined in 1.2.10, the extent of thickness measurements according to annex 2 may be specially considered by the Administration.

2.5.5 Transverse sections should be chosen where the largest reductions are suspected to occur or are revealed from deck plating measurements.

2.5.6 In cases where two or three sections should be measured, at least one should include a ballast tank within 0.5L amidships. In case of oil tankers of 130 m in length and upwards (as defined in the International Convention on Load Lines in force) and more than 10 years of age, for the evaluation of the ship's longitudinal strength as required in 8.1.2, the sampling method of thickness measurements is given in annex 12.

2.6 *Extent of tank pressure testing*

2.6.1 The minimum requirements for tank pressure testing at the renewal survey are given in annex 3.

2.6.2 The surveyor may extend the tank pressure testing as deemed necessary.

2.6.3 Boundaries of ballast tanks should be tested with a head of liquid to the top of air pipes.

2.6.4 Boundaries of cargo tanks should be tested to the highest point that liquid will rise under service conditions.

3 Annual survey

3.1 *General*

The annual survey should consist of an examination for the purpose of ensuring, as far as practicable, that the hull and piping are maintained in a satisfactory condition and should take into account the service history, condition and extent of the corrosion prevention system of ballast tanks and areas identified in the survey report file.

3.2 *Examination of the hull*

3.2.1 Examination of the hull plating and its closing appliances should be carried out as far as can be seen.

3.2.2 Examination of watertight penetrations should be carried out as far as practicable.

3.3 *Examination of weather decks*

3.3.1 Examination of cargo tank openings including gaskets, covers, coamings and flame screens.

3.3.2 Examination of cargo tank pressure/vacuum valves and flame screens.

3.3.3 Examination of flame screens on vents to all bunker tanks.

3.3.4 Examination of cargo, crude oil washing, bunker and vent piping systems, including vent masts and headers.

3.4 *Examination of cargo pump-rooms and pipe tunnels if fitted*

3.4.1 Examination of all pump-room bulkheads for signs of oil leakage or fractures and, in particular, the sealing arrangements of all penetrations of pump-room bulkheads.

3.4.2 Examination of the condition of all piping systems and pipe tunnels.

3.5 *Examination of ballast tanks*

3.5.1 Examination of ballast tanks should be carried out when required as a consequence of the results of the renewal survey and intermediate survey. When considered necessary by the Administration or when extensive corrosion is found, thickness measurements should be carried out.

3.5.2 Where substantial corrosion as defined in 1.2.8 is found, the extent of thickness measurements should be increased in accordance with the requirements in annex 4. These extended thickness measurements should be carried out before the survey is credited as completed. Suspect areas identified at previous surveys should be examined. Areas of substantial corrosion identified at previous surveys should have thickness measurements taken.

4 Intermediate survey

4.1 General

4.1.1 Items that are additional to the requirements of the annual survey may be surveyed either at the second or third annual survey or between these surveys.

4.1.2 The survey extent of cargo and ballast tanks dependent on the age of the ship is specified in 4.2, 4.3 and 4.4.

4.1.3 For weather decks, an examination as far as applicable of cargo, crude oil washing, bunker, ballast, steam and vent piping systems as well as vent masts and headers should be carried out. If upon examination there is any doubt as to the condition of the piping, the piping may be required to be pressure tested, thickness measured or both.

4.1.4 Concurrent crediting to both intermediate survey and renewal survey for surveys and thickness measurements of spaces should not be acceptable.

4.2 Oil tankers 5 to 10 years of age

4.2.1 The requirements of 4.1.3 apply.

4.2.2 All ballast tanks should be examined. When considered necessary by the Administration, thickness measurement and testing should be carried out to ensure that the structural integrity remains effective.

4.2.3 A ballast tank should be examined at subsequent annual intervals where:

- .1 a hard protective coating has not been applied from the time of construction; or
- .2 a soft or semi-hard coating has been applied; or
- .3 substantial corrosion is found within the tanks; or
- .4 the hard protective coating is found to be in less than GOOD condition and the hard protective coating is not repaired to the satisfaction of the surveyor.

4.2.4 In addition to the requirements above, suspect areas identified at previous surveys should be examined.

4.3 Oil tankers 10 to 15 years of age

4.3.1 The requirements of the intermediate survey should be to the same extent as the previous renewal survey as required in 2 and 5.1. However, pressure testing of cargo and ballast tanks and the requirements for longitudinal strength evaluation of hull girder as required in 8.1.2 are not required unless deemed necessary by the Administration.

4.3.2 In application of 4.3.1, the intermediate survey may be commenced at the second annual survey and be progressed during the succeeding year with a view to completion at the third annual survey in lieu of the application of 2.1.1.

4.3.3 In application of 4.3.1, an underwater survey may be considered in lieu of the requirements of 2.2.

4.4 *Oil tankers exceeding 15 years of age*

4.4.1 The requirements of the intermediate survey should be to the same extent as the previous renewal survey as required in 2 and 5.1. However, pressure testing of cargo and ballast tanks and the requirements for longitudinal strength evaluation of hull girder as required in 8.1.2 are not required unless deemed necessary by the Administration.

4.4.2 In application of 4.4.1, the intermediate survey may be commenced at the second annual survey and be progressed during the succeeding year with a view to completion at the third annual survey in lieu of the application of 2.1.1.

4.4.3 In application of 4.4.1 a survey in dry-dock should be part of the intermediate survey. The overall and close-up surveys and thickness measurements, as applicable, of the lower portions of the cargo tanks and water ballast tanks should be carried out in accordance with the applicable requirements for intermediate surveys, if not already performed.

Note: Lower portions of the cargo and ballast tanks are considered to be the parts below the light ballast water line.

5 Preparations for survey

5.1 *Survey programme*

5.1.1 The owner in cooperation with the Administration or organization recognized by the Administration should work out a specific survey programme prior to the commencement of any part of:

- .1 the renewal survey, and
- .2 the intermediate survey for oil tanker over 10 years of age.

The survey programme at intermediate survey may consist of the survey programme at the previous renewal survey supplemented by the condition evaluation report of that renewal survey and later relevant survey reports. The survey programme should be worked out taking into account any amendments to the survey requirements implemented after the last renewal survey carried out. The survey programme should be in a written format based on the information in annex 6A. The survey should not commence until the survey programme has been agreed.

5.1.1.1 Prior to the development of the survey programme, the survey planning questionnaire should be completed by the owner based on the information set out in annex 6B, and forwarded to the Administration.

5.1.2 In developing the survey programme, the following documentation should be collected and consulted with a view to selecting tanks, areas, and structural elements to be examined:

- .1 survey status and basic ship information;
- .2 documentation on board, as described in 6.2 and 6.3;
- .3 main structural plans of cargo and ballast tanks (scantlings drawings), including information regarding use of high-tensile steels (HTS);
- .4 Condition Evaluation Report, according to annex 9;
- .5 relevant previous damage and repair history;
- .6 relevant previous survey and inspection reports from both the recognized organization and the owner;
- .7 cargo and ballast history for the last 3 years, including carriage of cargo under heated conditions;
- .8 details of the inert gas plant and tank cleaning procedures;
- .9 information and other relevant data regarding conversion or modification of the ship's cargo and ballast tanks since the time of construction;
- .10 description and history of the coating and corrosion protection system (including anodes and previous class notations), if any;
- .11 inspections of the owner's personnel during the last three years with reference to structural deterioration in general, leakages in tank boundaries and piping and condition of the coating and corrosion protection system (including anodes) if any. Guidance for reporting is shown in annex 5;
- .12 information regarding the relevant maintenance level during operation, including port State control reports of inspection containing hull related deficiencies, safety management system non-conformities relating to hull maintenance, including the associated corrective action(s); and
- .13 any other information that will help identify suspect areas and critical structural areas.

5.1.3 The submitted survey programme should account for and comply, as a minimum, with the requirements of 2.6 and annexes 1, 2 and 3 for close-up survey, thickness measurement and tank testing, respectively, and should include relevant information including at least:

- .1 basic ship information and particulars;
- .2 main structural plans of cargo and ballast tanks (scantling drawings), including information regarding use of high tensile steels (HTS);
- .3 plan of tanks;
- .4 list of tanks with information on their use, corrosion prevention system and condition of coating;

-
- .5 conditions for survey (e.g. information regarding tank cleaning, gas freeing, ventilation, lighting, etc.);
 - .6 provisions and methods for access to structures;
 - .7 equipment for surveys;
 - .8 identification of tanks and areas for close-up survey (see 2.4);
 - .9 identification of areas and sections for thickness measurement (see 2.5);
 - .10 identification of tanks for tank testing (see 2.6);
 - .11 identification of the thickness measurement company;
 - .12 damage experience related to the ship in question; and
 - .13 critical structural areas and suspect areas, where relevant.

5.1.4 The Administration will advise the owner of the maximum acceptable structural corrosion diminution levels applicable to the ship.

5.1.5 Use may also be made of the Guidelines for technical assessment in conjunction with the planning of enhanced surveys for tankers, contained in annex 11. These Guidelines are a recommended tool which may be invoked at the discretion of the Administration, when considered necessary and appropriate, in conjunction with the preparation of the required survey programme.

5.2 *Conditions for survey*

5.2.1 The owner should provide the necessary facilities for a safe execution of the survey.¹⁶

5.2.1.1 In order to enable the attending surveyors to carry out the survey, provisions for proper and safe access should be agreed between the owner and the Administration.

5.2.1.2 Details of the means of access should be provided in the survey planning questionnaire.

5.2.1.3 In cases where the provisions of safety and required access are judged by the attending surveyors not to be adequate, the survey of the spaces involved should not proceed.

5.2.2 Tanks and spaces should be safe for access. Tanks and spaces should be gas-free and properly ventilated. Prior to entering tank, void or enclosed space, it should be verified that the atmosphere in that space is free from hazardous gas and contains sufficient oxygen.

5.2.3 In preparation for survey and thickness measurements and to allow for a thorough examination, all spaces should be cleaned including removal from surfaces of all loose accumulated corrosion scale. Spaces should be sufficiently clean and free from water, scale, dirt, oil residues, etc., to reveal corrosion, deformation, fractures, damages or other structural

¹⁶ Refer to chapter 10 of the International Safety Guide for Oil Tankers and Terminals (ISGOTT), Entry into and working in enclosed spaces.

deterioration as well as the condition of the coating. However, those areas of structure whose renewal has already been decided by the owner need only be cleaned and descaled to the extent necessary to determine the limits of the areas to be renewed.

5.2.4 Sufficient illumination should be provided to reveal corrosion, deformation, fractures, damages or other structural deterioration as well as the condition of the coating.

5.2.5 Where soft or semi-hard coatings have been applied, safe access should be provided for the surveyor to verify the effectiveness of the coating and to carry out an assessment of the condition of internal structures which may include spot removal of the coating. When safe access cannot be provided, the soft or semi-hard coating should be removed.

5.2.6 The surveyor(s) should always be accompanied by at least one responsible person, assigned by the owner, experienced in tank and enclosed spaces inspection. In addition a backup team of at least two experienced persons should be stationed at the hatch opening of the tank or space that is being surveyed. The back-up team should continuously observe the work in the tank or space and should keep life-saving and evacuation equipment ready for use.

5.2.7 A communication system should be arranged between the survey party in the tank or space being examined, the responsible officer on deck and, as the case may be, the navigation bridge. The communication arrangements should be maintained throughout the survey.

5.3 *Access to structures*¹⁷

5.3.1 For overall survey, means should be provided to enable the surveyor to examine the structure in a safe and practical way.

5.3.2 For close-up surveys, one or more of the following means for access, acceptable to the surveyor, should be provided:

- .1 permanent staging and passages through structures;
- .2 temporary staging and passages through structures;
- .3 lifts and moveable platforms;
- .4 boats or rafts;
- .5 portable ladders; and/or
- .6 other equivalent means.

5.4 *Equipment for survey*

5.4.1 Thickness measurement should normally be carried out by means of ultrasonic test equipment. The accuracy of the equipment should be proven to the surveyor as required.

¹⁷ Refer to MSC/Circ.686, Guidelines on the means of access to structures for inspection and maintenance of oil tankers and bulk carriers.

5.4.2 One or more of the following fracture detection procedures may be required if deemed necessary by the surveyor:

- .1 radiographic equipment;
- .2 ultrasonic equipment;
- .3 magnetic particle equipment;
- .4 dye penetrant; and/or
- .5 other equivalent means.

5.4.3 Explosimeter, oxygen-meter, breathing apparatus, lifelines, riding belts with rope and hook and whistles together with instructions and guidance on their use should be made available during the survey. A safety checklist should be provided.

5.4.4 Adequate and safe lighting should be provided for the safe and efficient conduct of the survey.

5.4.5 Adequate protective clothing should be made available and used (e.g. safety helmet, gloves, safety shoes, etc.) during the survey.

5.5 *Surveys at sea or at anchorage*

5.5.1 Surveys at sea or at anchorage may be accepted provided the surveyor(s) is given the necessary assistance from the personnel on board. Necessary precautions and procedures for carrying out the survey should be in accordance with 5.1, 5.2, 5.3 and 5.4.

5.5.2 A communication system should be arranged between the survey party in the tank and the responsible officer on deck. This system should also include the personnel in charge of ballast pump handling if boats or rafts are used.

5.5.3 Surveys of tanks by means of boats or rafts may only be undertaken with the agreement of the surveyor, who should take into account the safety arrangements provided, including weather forecasting and ship response under foreseeable conditions and provided the expected rise of water within the tank does not exceed 0.25 m.

5.5.4 When rafts or boats are used for close-up survey the following conditions should be observed:

- .1 only rough duty, inflatable rafts or boats, having satisfactory residual buoyancy and stability even if one chamber is ruptured, should be used;
- .2 the boat or raft should be tethered to the access ladder and an additional person should be stationed down the access ladder with a clear view of the boat or raft;
- .3 appropriate lifejackets should be available for all participants;
- .4 the surface of water in the tank should be calm (under all foreseeable conditions the expected rise of water within the tank should not exceed 0.25 m) and the water level stationary. On no account should the level of the water be rising while the boat or raft is in use;

- .5 the tank or space must contain clean ballast water only. Even a thin sheen of oil on the water is not acceptable;
- .6 at no time should the water level be allowed to be within 1 m of the deepest under-deck web face flat so that the survey team is not isolated from a direct escape route to the tank hatch. Filling to levels above the deck transverses should only be contemplated if a deck access manhole is fitted and open in the bay being examined, so that an escape route for the survey party is available at all times. Other effective means of escape to the deck may be considered; and
- .7 if the tanks (or spaces) are connected by a common venting system, or inert gas system, the tank in which the boat or raft should be used should be isolated to prevent a transfer of gas from other tanks (or spaces).

5.5.5 Rafts or boats alone may be allowed for inspection of the underdeck areas of tanks or spaces if the depth of the webs is 1.5 m or less.

5.5.6 If the depth of the webs is more than 1.5 m, rafts or boats alone may be allowed only:

- .1 when the coating of the under-deck structure is in GOOD condition and there is no evidence of wastage; or
- .2 if a permanent means of access is provided in each bay to allow safe entry and exit. This means:
 - .1 access direct from the deck via a vertical ladder with a small platform fitted approximately 2 m below the deck; and
 - .2 access to deck from a longitudinal permanent platform having ladders to deck in each end of the tank. The platform should, for the full length of the tank, be arranged in level with, or above, the maximum water level needed for rafting of under deck structure. For this purpose, the ullage corresponding to the maximum water level should be assumed not more than 3 m from the deck plate measured at the midspan of deck transverses and in the middle length of the tanks (see figure 1).

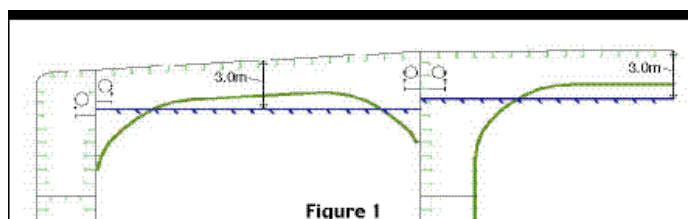

If neither of the above conditions are met, then staging or other equivalent means should be provided for the survey of the under-deck areas.

5.5.7 The use of rafts or boats alone in 5.5.5 and 5.5.6 does not preclude the use of boats or rafts to move about within a tank during a survey.

5.6 *Survey planning meeting*

5.6.1 Proper preparation and close cooperation between the attending surveyor(s) and the owner's representatives on board prior to and during the survey are an essential part in the safe and efficient conduct of the survey. During the survey onboard safety meetings should be held regularly.

5.6.2 Prior to commencement of any part of the renewal and intermediate survey, a survey planning meeting should be held between the attending surveyor(s), the owner's representative in attendance, the thickness measurement company operator (as applicable) and the master of the ship or an appropriately qualified representative nominated by the master or company for the purpose to ascertain that all the arrangements envisaged in the survey programme are in place, so as to ensure the safe and efficient conduct of the survey work to be carried out.

5.6.3 The following is an indicative list of items that should be addressed in the meeting:

- .1 schedule of the ship (i.e. the voyage, docking and undocking manoeuvres, periods alongside, cargo and ballast operations, etc.);
- .2 provisions and arrangements for thickness measurements (i.e. access, cleaning/de-scaling, illumination, ventilation, personal safety);
- .3 extent of the thickness measurements;
- .4 acceptance criteria (refer to the list of minimum thicknesses);
- .5 extent of close-up survey and thickness measurement considering the coating condition and suspect areas/areas of substantial corrosion;
- .6 execution of thickness measurements;
- .7 taking representative readings in general and where uneven corrosion/pitting is found;
- .8 mapping of areas of substantial corrosion; and
- .9 communication between attending surveyor(s), the thickness measurement company operator(s), and owner representative(s) concerning findings.

6 Documentation on board

6.1 *General*

6.1.1 The owner should obtain, supply and maintain on board the ship documentation as specified in 6.2 and 6.3, which should be readily available for the surveyor. The condition evaluation report referred to in 6.2 should include a translation into English.

6.1.2 The documentation should be kept on board for the lifetime of the ship.

6.2 *Survey report file*

6.2.1 A survey report file should be a part of the documentation on board consisting of:

- .1 reports of structural surveys (annex 8);
- .2 condition evaluation report (annex 9); and
- .3 thickness measurement reports (annex 10).

6.2.2 The survey report file should be available also in the owner's and the Administration offices, or in the office of the organization recognized by the Administration.

6.3 *Supporting documents*

The following additional documentation should be available on board:

- .1 main structural plans of cargo and ballast tanks;
- .2 previous repair history;
- .3 cargo and ballast history;
- .4 extent of use of inert gas plant and tank cleaning procedures;
- .5 inspections by ship's personnel with reference to:
 - .1 structural deterioration in general;
 - .2 leakages in bulkheads and piping; and
 - .3 condition of coating or corrosion prevention system, if any. Guidance for reporting is shown in annex 5; and
- .6 survey programme as required by 5.1 until such time as the renewal survey has been completed; and
- .7 any other information that would help to identify critical structural areas and/or suspect areas requiring inspection.

6.4 *Review of documentation on board*

Prior to survey, the surveyor should examine the completeness of the documentation on board and its contents as a basis for the survey.

7 Procedures for thickness measurements

7.1 *General*

7.1.1 The required thickness measurements, if not carried out by the recognized organization acting on behalf of the Administration, should be witnessed by a surveyor of the recognized organization. The surveyor should be on board to the extent necessary to control the process.

7.1.2 The thickness measurement company should be part of the survey planning meeting to be held prior to commencing the survey.

7.1.3 Thickness measurements of structures in areas where close-up surveys are required should be carried out simultaneously with close-up surveys.

7.1.4 In all cases the extent of the thickness measurements should be sufficient as to represent the actual average condition.

7.2 *Certification of thickness measurement company*

The thickness measurements should be carried out by a qualified company certified by an organization recognized by the Administration according to principles stated in annex 7.

7.3 *Reporting*

7.3.1 A thickness measurement report should be prepared and submitted to the Administration. The report should give the location of measurements, the thickness measured as well as corresponding original thickness. Furthermore, the report should give the date when the measurements were carried out, type of measuring equipment, names of personnel and their qualifications and be signed by the operator. The thickness measurement report should follow the principles as specified in the recommended procedures for thickness measurements set out in annex 10.

7.3.2 The surveyor should review the final thickness measurement report and countersign the cover page.

8 Reporting and evaluation of survey

8.1 *Evaluation of survey report*

8.1.1 The data and information on the structural condition of the ship collected during the survey should be evaluated for acceptability and continued structural integrity of the ship.

8.1.2 In case of oil tankers of 130 m in length and upwards (as defined in the International Convention on Load Lines in force), the ship's longitudinal strength should be evaluated by using the thickness of structural members measured, renewed and reinforced, as appropriate, during the renewal survey of safety construction carried out after the ship reached 10 years of age, in accordance with the criteria for longitudinal strength of the ship's hull girder for oil tankers specified in annex 12.

8.1.3 The analysis of data should be carried out and endorsed by the Administration or recognized organization authorized by the Administration and the conclusions of the analysis should form a part of the condition evaluation report.

8.1.4 The final result of the evaluation of the ship's longitudinal strength required in 8.1.2, after renewal or reinforcement work of structural members, if carried out as a result of initial evaluation, should be reported as a part of the condition evaluation report.

8.2 *Reporting*

8.2.1 Principles for survey reporting are shown in annex 8.

8.2.2 When a survey is split between different survey stations, a report should be made for each portion of the survey. A list of items examined and/or tested (pressure-testing, thickness measurements, etc.) and an indication of whether the item has been credited, should be made available to the next attending surveyor(s), prior to continuing or completing the survey.

8.2.3 A condition evaluation report of the survey and results should be issued to the owner as shown in annex 9 and placed on board the ship for reference at future surveys. The condition evaluation report should be endorsed by the Administration or recognized organization authorized by the Administration.

ANNEX 1

REQUIREMENTS FOR CLOSE-UP SURVEY AT RENEWAL SURVEYS

Age ≤ 5 years Renewal Survey No. 1	5 < Age ≤ 10 years Renewal Survey No. 2	10 < Age ≤ 15 years Renewal Survey No. 3	Age > 15 years Renewal Survey No. 4 and subsequent
<p>(A) ONE WEB FRAME RING – in a ballast wing tank, if any, or a cargo wing tank used primarily for water ballast</p> <p>(B) ONE DECK TRANSVERSE – in a cargo tank</p> <p>(D) ONE TRANSVERSE BULKHEAD – in a ballast tank</p> <p>(D) ONE TRANSVERSE BULKHEAD – in a cargo wing tank</p> <p>(D) ONE TRANSVERSE BULKHEAD – in a cargo centre tank</p>	<p>(A) ALL WEB FRAME RINGS – in a ballast wing tank, if any, or a cargo wing tank used primarily for water ballast</p> <p>(B) ONE DECK TRANSVERSE – in each of the remaining ballast tanks, if any</p> <p>(B) ONE DECK TRANSVERSE – in a cargo wing tank</p> <p>(B) ONE DECK TRANSVERSE – in two cargo centre tanks</p> <p>(C) BOTH TRANSVERSE BULKHEADS in a wing ballast tank, if any, or a cargo wing tank used primarily for water ballast</p> <p>(D) ONE TRANSVERSE BULKHEAD – in each remaining ballast tank</p> <p>(D) ONE TRANSVERSE BULKHEAD – in a cargo wing tank</p> <p>(D) ONE TRANSVERSE BULKHEAD – in two cargo centre tanks</p>	<p>(A) ALL WEB FRAME RINGS – in all ballast tanks</p> <p>(A) ALL WEB FRAME RINGS – in a cargo wing tank</p> <p>(A) A minimum of 30% of all web frame rings in each remaining cargo wing tank (see note 1)</p> <p>(C) ALL TRANSVERSE BULKHEADS – in all cargo and ballast tanks</p> <p>(E) A minimum of 30% of deck and bottom transverses including adjacent structural members in each cargo centre tank (see note 1)</p> <p>(F) As considered necessary by the Administration</p>	<p>As for ships referred to in column 3 Additional transverses included as deemed necessary by the Administration</p>

Note 1:

The 30 per cent should be rounded up to the next whole integer.

- (A) Complete transverse web frame ring including adjacent structural members
- (B) Deck transverse including adjacent deck structural members
- (C) Transverse bulkheads complete – including girder system and adjacent members
- (D) Transverse bulkhead lower part – including girder system and adjacent structural members
- (E) Deck and bottom transverse including adjacent structural members
- (F) Additional complete transverse web ring frame

ANNEX 2

REQUIREMENTS FOR THICKNESS MEASUREMENTS AT RENEWAL SURVEYS

Age ≤ 5 years	5 < Age ≤ 10 years	10 < Age ≤ 15 years	Age > 15 years
1	2	3	4
<p>1 One section of deck plating for the full beam of the ship within the cargo area (in way of a ballast tank, if any, or a cargo tank used primarily for water ballast)</p> <p>2 Measurements of structural members subject to close-up survey according to annex 1, for general assessment and recording of corrosion pattern</p> <p>3 Suspect areas</p>	<p>1 Within the cargo area: .1 each deck plate .2 one transverse section</p> <p>2 Measurements of structural members subject to close-up survey according to annex 1, for general assessment and recording of corrosion pattern</p> <p>3 Suspect areas</p> <p>4 Selected wind and water strakes outside the cargo area</p>	<p>1 Within the cargo area: .1 each deck plate .2 two transverse sections¹⁸ .3 all wind and water strakes</p> <p>2 Measurements of structural members subject to close-up survey according to annex 1, for general assessment and recording of corrosion pattern</p> <p>3 Suspect areas</p> <p>4 Selected wind and water strakes outside the cargo area</p>	<p>1 Within the cargo area: .1 each deck plate .2 three transverse sections .3 each bottom plate</p> <p>2 Measurements of structural members subject to close-up survey according to annex 1, for general assessment and recording of corrosion pattern</p> <p>3 Suspect areas</p> <p>4 All wind and water strakes in full length</p>

¹⁸ At least one section should include a ballast tank within 0.5 L amidships.

ANNEX 3

REQUIREMENTS FOR TANK PRESSURE TESTING AT RENEWAL SURVEYS

Age ≤ 5 years		Age > 5 years			
1		2			
1	Cargo tank boundaries facing ballast tanks, void spaces, pipe tunnels, fuel oil tanks, pump-rooms or cofferdams	1	All ballast tank boundaries		
2	All ballast tank boundaries.	2	All cargo tank bulkheads		

ANNEX 4

**REQUIREMENTS FOR EXTENT OF THICKNESS MEASUREMENTS AT
AREAS OF SUBSTANTIAL CORROSION****Renewal survey within the cargo area****Bottom structure**

Structural member	Extent of measurement	Pattern of measurement
1 Bottom plating	Minimum of three bays across tank, including aft bay. Measurements around and under all bell mouths	Five-point pattern for each panel between longitudinals and webs
2 Bottom longitudinals	Minimum of three longitudinals in each bay where bottom plating measured	Three measurements in line across flange and three measurements on vertical web
3 Bottom girders and brackets	At fore and aft transverse bulkhead bracket toes and in centre of tanks	Vertical line of single measurements on web plating with one measurement between each panel stiffener, or a minimum of three measurements. Two measurements across face flat. Five-point pattern on girder/bulkhead brackets
4 Bottom transverse webs	Three webs in bays where bottom plating measured, with measurements at both ends and middle	Five-point pattern over 2 m ² area. Single measurements on face flat.
5 Panel stiffening	Where fitted	Single measurements

Deck structure

Structural member	Extent of measurement	Pattern of measurement
1 Deck plating	Two bands across tank	Minimum of three measurements per plate per band
2 Deck longitudinals	Minimum of three longitudinals in each of two bays	Three measurements in line vertically on webs, and two measurements on flange (if fitted)
3 Deck girders and brackets	At fore and aft transverse bulkhead, bracket toes and in centre of tanks	Vertical line of single measurements on web plating with one measurement between each panel stiffener, or a minimum of three measurements. Two measurements across face flat. Five-point pattern on girder/bulkhead brackets
4 Deck transverse webs	Minimum of two webs with measurements at middle and both ends of span	Five-point pattern over about 2 m ² area. Single measurements on face flat
5 Panel stiffening	Where available	Single measurements

Shell and longitudinal bulkheads

Structural member	Extent of measurement	Pattern of measurement
1 Deckhead and bottom strakes, and strakes in way of stringer platforms	Plating between each pair of longitudinals in a minimum of three bays	Single measurement
2 All other strakes	Plating between every third pair of longitudinals in same three bays	Single measurement
3 Longitudinals – deckhead and bottom strakes	Each longitudinal in same three bays	Three measurements across web and one measurement on flange
4 Longitudinals – all others	Every third longitudinal in same three bays	Three measurements across web and one measurement on flange
5 Longitudinals – bracket	Minimum of three at top, middle and bottom of tank in same three bays	Five-point pattern over area of bracket
6 Web frames and cross ties	Three webs with minimum of three locations on each web, including in way of cross tie connections	Five-point pattern over about 2 m ² area, plus single measurements on web frame and cross tie face flats

Transverse bulkheads and swash bulkheads

Structural member	Extent of measurement	Pattern of measurement
1 Deckhead and bottom strakes, and strakes in way of stringer platforms	Plating between pair of stiffeners at three locations – approximately quarter, half and three-quarters width of tank	Five-point pattern between stiffeners over 1 m length
2 All other strakes	Plating between pair of stiffeners at middle location	Single measurement
3 Strakes in corrugated bulkheads	Plating for each change of scantling at centre of panel and at flange or fabricated connection	Five-point pattern over about 1 m ² of plating
4 Stiffeners	Minimum of three typical stiffeners	For web, five-point pattern over span between bracket connections (two measurements across web at each bracket connection, and one at centre of span). For flange, single measurements at each bracket toe and at centre of span
5 Brackets	Minimum of three at top, middle and bottom of tank	Five-point pattern over area of bracket
6 Deep webs and girders	Measurements at toe of bracket and centre of span	For web, five-point pattern over about 1 m ² area. Three measurements across face flat
7 Stringer platforms	All stringers with measurements at both ends and middle	Five-point pattern over 1 m ² area plus single measurements near bracket toes and on face flats

ANNEX 5

OWNER'S INSPECTION REPORT

Structural condition							
Ship's name:							
Owners's inspection report – Structural condition							
For tank No:							
Grade of steel: deck: side:							
bottom: longitudinal bulkhead:							
Elements	Cracks	Buckles	Corrosion	Coating	Pitting	Modification/repair	Other
				condition			
Deck:							
Bottom:							
Side:							
Longitudinal bulkheads:							
Transverse bulkheads:							
Repairs carried out due to:							
Thickness measurements carried out (dates):							
Results in general:							
Overdue surveys:							
Outstanding conditions of class:							
Comments:							
Date of inspection:							
Inspected by:							
Signature:							

ANNEX 6A

SURVEY PROGRAMME**Basic information and particulars**

Name of ship:
IMO number:
Flag State:
Port of registry:
Gross tonnage:
Deadweight (metric tonnes):
Length between perpendiculars (m):
Shipbuilder:
Hull number:
Recognized organization (RO):
RO ship identity:
Date of delivery of the ship:
Owner:
Thickness measurement company:

1 Preamble1.1 *Scope*

1.1.1 The present survey programme covers the minimum extent of overall surveys, close-up surveys, thickness measurements and pressure testing within the cargo area, ballast tanks, including fore and aft peak tanks, required by the Code.

1.1.2 The arrangements and safety aspects of the survey should be acceptable to the attending surveyor(s).

1.2 *Documentation*

All documents used in the development of the survey programme should be available on board during the survey as required by section 6.

2 Arrangement of tanks and spaces

This section of the survey programme should provide information (either in the form of plans or text) on the arrangement of tanks and spaces that fall within the scope of the survey.

3 List of tanks and spaces with information on their use, extent of coatings and corrosion prevention system

This section of the survey programme should indicate any changes relating to (and should update) the information on the use of the tanks of the ship, the extent of coatings and the corrosion protective system provided in the survey planning questionnaire.

4 Conditions for survey

This section of the survey programme should provide information on the conditions for survey, e.g. information regarding cargo hold and tank cleaning, gas freeing, ventilation, lighting, etc.

5 Provisions and method of access to structures

This section of the survey programme should indicate any changes relating to (and should update) the information on the provisions and methods of access to structures provided in the survey planning questionnaire.

6 List of equipment for survey

This section of the survey programme should identify and list the equipment that will be made available for carrying out the survey and the required thickness measurements.

7 Survey requirements

7.1 Overall survey

This section of the survey programme should identify and list the spaces that should undergo an overall survey for the ship in accordance with 2.4.1.

7.2 Close-up survey

This section of the survey programme should identify and list the hull structures that should undergo a close-up survey for the ship in accordance with 2.4.2.

8 Identification of tanks for tank testing

This section of the survey programme should identify and list the tanks that should undergo tank testing for the ship in accordance with 2.6.

9 Identification of areas and sections for thickness measurements

This section of the survey programme should identify and list the areas and sections where thickness measurements should be taken in accordance with 2.5.1.

10 Minimum thickness of hull structures

This section of the survey programme should specify the minimum thickness for hull structures of the ship that are subject to the Code (indicate either (a) or preferably (b), if such information is available):

- (a) Determined from the attached wastage allowance table and the original thickness to the hull structure plans of the ship;

(b) Given in the following table(s):

Area or location	Original as-built thickness (mm)	Minimum thickness (mm)	Substantial corrosion thickness (mm)
Deck			
Plating			
Longitudinals			
Longitudinal girders			
Bottom			
Plating			
Longitudinals			
Longitudinal girders			
Ship side			
Plating			
Longitudinals			
Longitudinal girders			
Longitudinal bulkhead			
Plating			
Longitudinals			
Longitudinal girders			
Inner bottom			
Plating			
Longitudinals			
Longitudinal girders			
Transverse bulkheads			
Plating			
Stiffeners			
Transverse web frames, floors and stringers			
Plating			
Flanges			
Stiffeners			
Cross ties			
Flanges			
Webs			

Note: The wastage allowance tables should be attached to the survey programme.

11 Thickness measurement company

This section of the survey programme should identify changes, if any, relating to the information on the thickness measurement company provided in the survey planning questionnaire.

12 Damage experience related to the ship

This section of the survey programme should, using the tables provided below, provide details of the hull damages for at least the last three years in way of the cargo and ballast tanks and void spaces within the cargo area. These damages are subject to survey.

Hull damages sorted by location for the ship

Tank or space number or area	Possible cause, if known	Description of the damages	Location	Repair	Date of repair

Hull damages for sister or similar ships (if available) in the case of design related damage

Tank or space number or area	Possible cause, if known	Description of the damages	Location	Repair	Date of repair

13 Areas identified with substantial corrosion from previous surveys

This section of the survey programme should identify and list the areas of substantial corrosion from previous surveys.

14 Critical structural areas and suspect areas

This section of the survey programme should identify and list the critical structural areas and the suspect areas, if such information is available.

15 Other relevant comments and information

This section of the survey programme should provide any other comments and information relevant to the survey.

Appendices

Appendix 1 – List of plans

Paragraph 5.1.3.2 requires that main structural plans of cargo and ballast tanks (scantling drawings), including information on regarding use of high tensile steel (HTS), to be available. This appendix of the survey programme should identify and list the main structural plans which form part of the survey programme.

Appendix 2 – Survey planning questionnaire

The survey planning questionnaire (annex 6B), which has been submitted by the owner, should be appended to the survey programme.

Appendix 3 – Other documentation

This part of the survey programme should identify and list any other documentation that forms part of the plan.

Prepared by the owner in cooperation with the Administration for compliance with 5.1.3.

Date:

(name and signature of authorized owner's representative)

Date:

(name and signature of authorized representative of the Administration)

ANNEX 6B

SURVEY PLANNING QUESTIONNAIRE

The following information will enable the owner in cooperation with the Administration to develop a survey programme complying with the requirements of the Code. It is essential that the owner provides, when completing the present questionnaire, up-to-date information. The present questionnaire, when completed, should provide all information and material required by the resolution.

Particulars

Ship's name:

IMO number:

Flag State:

Port of registry:

Owner:

Recognized organization (RO):

Gross tonnage:

Deadweight (metric tonnes):

Date of delivery:

Information on access provision for close-up surveys and thickness measurement

The owner should indicate, in the table below, the means of access to the structures subject to close-up survey and thickness measurement. A close-up survey is an examination where the details of structural components are within the close visual inspection range of the attending surveyor, i.e. normally within reach of hand.

Tank No.	Structure	C (Cargo)/B (Ballast)	Temporary staging	Rafts	Ladders	Direct access	Other means (please specify)
F.P.	Fore peak						
A.P.	Aft peak						
Wing tanks	Underdeck						
	Side shell						
	Bottom transverse						
	Longitudinal						
	Transverse						
Centre tanks	Under deck						
	Bottom transverse						
	Transverse						

History of cargo with H₂S content or heated cargo for the last three years together with indication as to whether cargo was heated and, where available, Material Safety Data Sheets (MSDS)¹⁹

Owner's inspections

Using a format similar to that of the table below (which is given as an example), the owner should provide details of the results of their inspections for the last three years on all cargo and ballast tanks and void spaces within the cargo area, including peak tanks.

Tank No.	Corrosion protection (1)	Coating extent (2)	Coating condition (3)	Structural deterioration (4)	Tank damage history (5)
Cargo centre tanks					
Cargo wing tanks					
Slop					
Ballast tanks					
Aft peak					
Fore peak					
Miscellaneous spaces					

Note:

Indicate tanks which are used for oil/ballast.

- 1) HC = hard coating; SC = soft coating;
A = anodes; NP = no protection
- 2) U = upper part; M = middle part;
L = lower part; C = complete
- 3) G = good; F = fair; P = poor;
RC = recoated (during the last three years)
- 4) N = no findings recorded; Y = findings recorded,
description of findings should be attached to this questionnaire
- 5) DR = Damage & Repair; L = Leakages;
CV = Conversion (description to be attached to this questionnaire)

Name of owner's representative:

.....

Signature:

Date:

¹⁹ Refer to resolution MSC.150(77) on Recommendation for material safety data sheets for MARPOL Annex I cargoes and marine fuel oils.

Reports of port State control inspections

List the reports of port State control inspections containing hull structural related deficiencies, relevant information on rectification of the deficiencies:

Safety management system

List non-conformities related to hull maintenance, including the associated corrective actions:

Name and address of the approved thickness measurement company

ANNEX 7

PROCEDURES FOR CERTIFICATION OF A COMPANY ENGAGED IN THICKNESS MEASUREMENT OF HULL STRUCTURES**1 Application**

This guidance applies for certification of the company which intends to engage in the thickness measurement of hull structures of ships.

2 Procedures for certification*Submission of documents*

2.1 The following documents should be submitted to an organization recognized by the Administration for approval:

- .1 outline of the company, e.g. organization and management structure;
- .2 experience of the company on thickness measurement of hull structures of ships;
- .3 technicians' careers, i.e. experience of technicians as thickness measurement operators, technical knowledge and experience of hull structure, etc. Operators should be qualified according to a recognized industrial NDT Standard;
- .4 equipment used for thickness measurement such as ultrasonic testing machines and their maintenance/calibration procedures;
- .5 a guide for thickness measurement operators;
- .6 training programmes for technicians for thickness measurement; and
- .7 measurement record format in accordance with recommended procedures for thickness measurements (see annex 10).

Auditing of the company

2.2 Upon reviewing the documents submitted with satisfactory results, the company should be audited in order to ascertain that the company is duly organized and managed in accordance with the documents submitted, and eventually is capable of conducting thickness measurement of the hull structure of ships.

2.3 Certification is conditional upon an on board demonstration of thickness measurement as well as satisfactory reporting.

3 Certification

3.1 Upon satisfactory results of both the audit of the company referred to in 2.2 and the demonstration tests referred to in 2.3, the Administration or organization recognized by the Administration should issue a certificate of approval as well as a notice to the effect that the thickness measurement operation system of the company has been certified.

3.2 Renewal/endorsement of the certificate should be made at intervals not exceeding three years by verification that original conditions are maintained.

4 Report of any alteration to the certified thickness measurement operation system

In cases where any alteration to the certified thickness measurement operation system of the company is made, such an alteration should be immediately reported to the organization recognized by the Administration. Re-audit should be made where deemed necessary by the organization recognized by the Administration.

5 Withdrawal of the certification

The certification may be withdrawn in the following cases:

- .1 where the measurements were improperly carried out or the results were improperly reported;
- .2 where the surveyor found any deficiencies in the approved thickness measurement operation system of the company; and
- .3 where the company failed to report any alteration referred to in 4 to the organization recognized by the Administration as required.

ANNEX 8

SURVEY REPORTING PRINCIPLES

As a principle, for oil tankers subject to the Code, the surveyor should include the following contents in his report for survey of hull structure and piping systems, as relevant for the survey.

1 General

1.1 A survey report should be generated in the following cases:

- .1 in connection with commencement, continuation and/or completion of periodical hull surveys, i.e. annual, intermediate and renewal surveys, as relevant;
- .2 when structural damages/defects have been found;
- .3 when repairs, renewals or modifications have been carried out; and
- .4 when condition of class (recommendation) has been imposed or deleted.

1.2 The reporting should provide:

- .1 evidence that prescribed surveys have been carried out in accordance with applicable requirements;
- .2 documentation of surveys carried out with findings, repairs carried out and condition of class (recommendation) imposed or deleted;
- .3 survey records, including actions taken, which should form an auditable documentary trail. Survey reports should be kept in the survey report file required to be on board;
- .4 information for planning of future surveys; and
- .5 information which may be used as input for maintenance of classification rules and instructions.

1.3 When a survey is split between different survey stations, a report should be made for each portion of the survey. A list of items surveyed, relevant findings and an indication of whether the item has been credited, should be made available to the next attending surveyor, prior to continuing or completing the survey. Thickness measurement and tank testing carried out should also be listed for the next surveyor.

2 Extent of the survey

2.1 Identification of compartments where an overall survey has been carried out.

2.2 Identification of locations, in each tank, where a close-up survey has been carried out, together with information of the means of access used.

2.3 Identification of locations, in each tank, where thickness measurement has been carried out.

Note: As a minimum, the identification of location of close-up survey and thickness measurement should include a confirmation with description of individual structural members corresponding to the extent of requirements stipulated in this part of Annex B based on type of periodical survey and the ship's age.

Where only partial survey is required, i.e. one web frame ring/one deck transverse, the identification should include location within each ballast tank and cargo hold by reference to frame numbers.

2.4 For areas in tanks where protective coating is found to be in good condition and the extent of close-up survey and/or thickness measurement has been specially considered, structures subject to special consideration should be identified.

2.5 Identification of tanks subject to tank testing.

2.6 Identification of piping systems on deck, including crude oil washing (COW) piping, and ballast piping within cargo and ballast tanks, pipe tunnels, cofferdams and void spaces where:

- .1 examination, including internal examination of piping with valves and fittings and thickness measurement, as relevant, has been carried out; and
- .2 operational test to working pressure has been carried out.

3 Result of survey

3.1 Type, extent and condition of protective coating in each tank, as relevant (rated GOOD, FAIR or POOR), including identification of tanks fitted with anodes.

3.2 Structural condition of each compartment with information on the following, as relevant:

- .1 Identification of findings, such as:
 - .1 corrosion with description of location, type and extent;
 - .2 areas with substantial corrosion;
 - .3 cracks/fractures with description of location and extent;
 - .4 buckling with description of location and extent; and
 - .5 indents with description of location and extent.
- .2 Identification of compartments where no structural damages/defects are found. The report may be supplemented by sketches/photographs.
- .3 Thickness measurement report should be verified and signed by the surveyor controlling the measurements on board.

- .4 Evaluation result of longitudinal strength of the hull girder of oil tankers of 130 m in length and upwards and over 10 years of age. The following data should be included, as relevant:
- .1 measured and as-built transverse sectional areas of deck and bottom flanges;
 - .2 diminution of transverse sectional areas of deck and bottom flanges; and
 - .3 details of renewals or reinforcements carried out, as relevant (see 4.2).

4 Actions taken with respect to findings

4.1 Whenever the attending surveyor is of the opinion that repairs are required, each item to be repaired should be identified in a numbered list. Whenever repairs are carried out, details of the repairs effected should be reported by making specific reference to relevant items in the numbered list.

4.2 Repairs carried out should be reported with identification of:

- .1 compartment;
- .2 structural member;
- .3 repair method (i.e. renewal or modification), including:
 - .3.1 steel grades and scantlings (if different from the original);
 - .3.2 sketches/photographs, as appropriate;
- .4 repair extent; and
- .5 non-destructive tests (NDT).

4.3 For repairs not completed at the time of survey, condition of class/recommendation should be imposed with a specific time limit for the repairs. In order to provide correct and proper information to the surveyor attending for survey of the repairs, condition of class/recommendation should be sufficiently detailed with identification of each item to be repaired. For identification of extensive repairs, reference may be given to the survey report.

ANNEX 9

CONDITION EVALUATION REPORT

Issued upon completion of renewal survey

General particulars

Ship's name: Class/Administration identity number:
Previous class/Administration identity number(s):
IMO number:

Port of registry: National flag:
Previous national flag(s):

Deadweight (metric tonnes): Gross tonnage:
National:
ITC (1969):

Date of build: Classification notation:

Date of major conversion:

Type of conversion: Owner:
Previous owner(s):

1 The survey reports and documents listed below have been reviewed by the undersigned and found to be satisfactory.

2 A summary of the survey is attached herewith on sheet 2

3 The renewal survey has been completed in accordance with the present Code on (date)

Condition evaluation report completed by	Name Signature	Title
Office	Date	
Condition evaluation report verified by	Name Signature	Title
Office	Date	

Attached reports and documents:

- 1)
- 2)
- 3)
- 4)
- 5)
- 6)

Contents of condition evaluation report

- Part 1 – General particulars: - See front page
- Part 2 – Report review: - Where and how survey was done
- Part 3 – Close-up survey: - Extent (which tanks)
- Part 4 – Cargo and ballast piping system: - Examined
- Operationally tested
- Part 5 – Thickness measurements: - Reference to thickness measurement report
- Summary of where measured
- Separate form indicating the spaces with substantial corrosion, and corresponding:
- thickness diminution
- corrosion pattern
- Part 6 – Tank corrosion prevention system: - Separate form indicating:
- location of coating/anodes
- condition of coating (if applicable)
- Part 7 – Repairs: - Identification of spaces/areas
- Part 8 – Condition of class/flag State requirements:
- Part 9 – Memoranda: - Acceptable defects
- Any points of attention for future surveys, e.g. for suspect areas
- Extended annual/intermediate survey due to coating breakdown
- Part 10 – Evaluation results of the ship's longitudinal strength (for oil tankers of 130 m in length and upwards and over 10 years of age)
- Part 11 – Conclusion: - Statement on evaluation/verification of survey report

Extract of thickness measurements

Reference is made to the thickness measurement report:

Position of substantially corroded tanks/areas¹ or areas with deep pitting³	Thickness diminution [%]	Corrosion pattern²	Remarks: (e.g. reference to attached sketches)

Notes:

- 1 Substantial corrosion, i.e. 75 to 100 per cent of acceptable margins wasted.
- 2 P = Pitting
C = Corrosion in general
- 3 Any bottom plating with a pitting intensity of 20 per cent or more, with wastage in the substantial corrosion range or having an average depth of pitting of $\frac{1}{3}$ or more of actual plate thickness should be noted.

Tank corrosion prevention system

Tank Nos. ¹	Tank corrosion prevention system ²	Coating condition ³	Remarks

Notes:

- 1 All segregated ballast tanks and combined cargo/ballast tanks should be listed.
- 2 C = Coating NP = No protection
- 3 Coating condition according to the following standard:
 - GOOD condition with only minor spot rusting.
 - FAIR condition with local breakdown of coating at edges of stiffeners and weld connections and/or light rusting over 20 per cent or more of areas under consideration, but less than as defined for POOR condition.
 - POOR condition with general breakdown of coating over 20 per cent or more of areas or hard scale at 10 per cent or more of areas under consideration.

If coating condition less than GOOD is given, extended annual surveys should be introduced. This should be noted in part 9 of the Contents of condition evaluation report.

Evaluation result of longitudinal strength of the hull girder of oil tankers of 130 m in length and upwards and of over 10 years of age

(of sections 1, 2 and 3 below, only one applicable section should be completed)

1 This section applies to ships regardless of the date of construction: Transverse sectional areas of deck flange (deck plating and deck longitudinals) and bottom flange (bottom shell plating and bottom longitudinals) of the ship's hull girder have been calculated by using the thickness measured, renewed or reinforced, as appropriate, during the renewal survey of the Cargo Ship Safety Construction Certificate or the Cargo Ship Safety Certificate (SC renewal survey) most recently conducted after the ship reached 10 years of age, and found that the diminution of the transverse sectional area does not exceed 10 per cent of the as-built area, as shown in the following table:

Table 1 – Transverse sectional area of hull girder flange

		Measured	As-built	Diminution
Transverse section 1	Deck flange	cm ²	cm ²	cm ² (%)
	Bottom flange	cm ²	cm ²	cm ² (%)
Transverse section 2	Deck flange	cm ²	cm ²	cm ² (%)
	Bottom flange	cm ²	cm ²	cm ² (%)
Transverse section 3	Deck flange	cm ²	cm ²	cm ² (%)
	Bottom flange	cm ²	cm ²	cm ² (%)

2 This section applies to ships constructed on or after 1 July 2002: Section moduli of transverse section of the ship's hull girder have been calculated by using the thickness of structural members measured, renewed or reinforced, as appropriate, during the SC renewal survey most recently conducted after the ship reached 10 years of age in accordance with the provisions of paragraph 2.2.1.1 of annex 12, and are found to be within their diminution limits determined by the Administration, taking into account the recommendations adopted by the Organization,²⁰ as shown in the following table:

Table 2 – Transverse section modulus of hull girder

		Z _{act} (cm ³) ¹	Z _{req} (cm ³) ²	Remarks
Transverse section 1	Upper deck			
	Bottom			
Transverse section 2	Upper deck			
	Bottom			
Transverse section 3	Upper deck			
	Bottom			

Notes:

- 1 Z_{act} means the actual section moduli of the transverse section of the ship's hull girder calculated by using the thickness of structural members measured, renewed or reinforced, as appropriate, during the SC renewal survey, in accordance with the provisions of paragraph 2.2.1.1 of annex 12.
- 2 Z_{req} means the diminution limit of the longitudinal bending strength of ships, as calculated in accordance with the provisions of paragraph 2.2.1.1 of annex 12.

The calculation sheets for Z_{act} should be attached to this report.

²⁰ Refer to resolution MSC.108(73) on Recommendations on compliance with the requirements of paragraph 2.2.1.1 of annex 12 to annex B to resolution A.744(18).

3 This section applies to ships constructed before 1 July 2002: Section moduli of transverse sections of the ship's hull girder have been calculated by using the thickness of structural members measured, renewed or reinforced, as appropriate, during the SC renewal survey most recently conducted after the ship reached 10 years of age in accordance with the provisions of paragraph 2.2.1.2 of annex 12, and found to meet the criteria required by the Administration or the recognized classification society and that Z_{act} is not less than Z_{mc} (defined in note 2 below) as specified in appendix 2 to annex 12, as shown in the following table.

Describe the criteria for acceptance of the minimum section moduli of the ship's hull girder for ships in service required by the Administration or the recognized classification society.

Table 3 – Transverse section modulus of hull girder

		$Z_{act} (cm^3)^1$	$Z_{mc} (cm^3)^2$	Remarks
Transverse section 1	Upper deck			
	Bottom			
Transverse section 2	Upper deck			
	Bottom			
Transverse section 3	Upper deck			
	Bottom			

Notes:

- 1 As defined in note 1 of table 2.
- 2 Z_{mc} means the diminution limit of minimum section modulus calculated in accordance with the provisions of paragraph 2.2.1.2 of annex 12.

ANNEX 10

RECOMMENDED PROCEDURES FOR THICKNESS MEASUREMENTS

General

- 1 These procedures should be used for recording thickness measurements as required by annexes 2 and 4.
- 2 Reporting forms TM1-T, TM2-T(i), TM2-T(ii), TM3-T, TM4-T, TM5-T and TM6-T, set out in appendix 2, should be used for recording thickness measurements and the maximum allowable diminution should be stated. The maximum allowable diminution could be stated in an attached document.
- 3 Appendix 3 contains guidance diagrams and notes relating to the reporting forms and the requirements for thickness measurement.
- 4 The reporting forms should, where appropriate, be supplemented by data presented on structural sketches.

Appendix 1

GENERAL PARTICULARS

Ship's name:
IMO number:
Class/Administration identity number:
Port of registry:
Gross tonnage:
Deadweight:
Date of build:
Classification society:

Name of company performing thickness measurement:

Thickness measurement company certified by:

Certificate number:

Certificate valid from: to

Place of measurement:

First date of measurement:

Last date of measurement:

Periodical survey/intermediate survey²¹ due:

Details of measurement equipment:

Qualification of operator:

Report number: consisting of pages

Name of operator: Name of surveyor:

Signature of operator: Signature of surveyor:

Company official stamp: Administration:

Official stamp

²¹ Delete as appropriate.

Appendix 2

Report on thickness measurement of all deck plating, all bottom shell plating or side shell plating (TM1-T)

Ship's name..... Class Identity No..... Report No..... IMO number.....

STRAKE POSITION																		
	PLATE POSITION	No. or letter	Orig. thk. (mm)	Forward reading						Aft reading						Mean diminution %		Max. allow. dimin. (mm)
				Gauged		Diminution P		Diminution S		Gauged		Diminution P		Diminution S		P	S	
				P	S	mm	%	mm	%	P	S	mm	%	mm	%			
12th forward																		
11th																		
10th																		
9th																		
8th																		
7th																		
6th																		
5th																		
4th																		
3rd																		
2nd																		
1st																		
Amidships																		
1st aft																		
2nd																		
3rd																		
4th																		
5th																		
6th																		
7th																		
8th																		
9th																		
10th																		
11th																		
12th																		

Operator's signature.....

Notes – see following page

Notes to report TM1-T:

- 1 This report should be used for recording the thickness measurement of:
 - .1 All strength deck plating within the cargo area.
 - .2 All keel, bottom shell plating and bilge plating within the cargo area.
 - .3 Side shell plating including selected wind and water strakes outside the cargo area.
 - .4 All wind and water strakes within the cargo area
- 2 The strake position should be clearly indicated as follows:
 - .1 For strength deck plating, indicate the number of the strake of plating inboard from the stringer plate.
 - .2 For bottom plating, indicate the number of the strake of plating outboard from the keel plate.
 - .3 For side shell plating, give number of the strake of plating below sheer strake and letter as shown on shell expansion.
- 3 For oil tankers, all deck plating strakes should be recorded, for ore/oil ships only the deck plating strakes outside line of openings should be recorded.
- 4 Measurements should be taken at the forward and aft areas of all plates and where plates cross ballast/cargo tank boundaries, separate measurements for the area of plating in way of each type of tank should be recorded.
- 5 The single measurements recorded should represent the average of multiple measurements.
- 6 The maximum allowable diminution could be stated in an attached document.

Report on thickness measurement of shell and deck plating (one, two or three transverse sections) (TM2-T(i))

Ship's name..... Class Identity No..... Report No..... IMO number.....

STRENGTH DECK AND SHEERSTRAKE PLATING																											
STRAKE POSITION	FIRST TRANSVERSE SECTION AT FRAME NUMBER....								SECOND TRANSVERSE SECTION AT FRAME NUMBER....								THIRD TRANSVERSE SECTION AT FRAME NUMBER....										
	No. or letter	Orig. thk. mm	Max allow. dimin. mm	Gauged		Diminution P		Diminution S		No. or letter	Orig. thk. mm	Max allow. dimin. mm	Gauged		Diminution P		Diminution S		No. or letter	Orig. thk. mm	Max allow. dimin. mm	Gauged		Diminution P		Diminution S	
				P	S	mm	%	mm	%				P	S	mm	%	mm	%				P	S	mm	%	mm	%
Stringer plate																											
1st stake inboard																											
2nd																											
3rd																											
4th																											
5th																											
6th																											
7th																											
8th																											
9th																											
10th																											
11th																											
12th																											
13th																											
14th																											
centre strake																											
sheerstrake																											
TOPSIDE																											
TOTAL																											

Operator's signature.....

Notes – see following page

Notes to report TM2-T(i):

- 1 This report should be used for recording the thickness measurement of strength deck plating and sheerstrake plating transverse sections:

One, two or three sections within the cargo area comprising structural items (1), (2) and (3) as shown on the diagrams of typical transverse section indicating longitudinal and transverse members, in appendix 3.
- 2 For oil tankers all deck plating strakes should be recorded, for ore/oil ships only the deck plating strakes outside line of openings should be recorded.
- 3 The topside area comprises deck plating, stringer plate and sheerstrake (including rounded gunwales).
- 4 The exact frame station of measurement should be stated.
- 5 The single measurements recorded should represent the average of multiple measurements.
- 6 The maximum allowable diminution could be stated in an attached document.

Report on thickness measurement of shell and deck plating (one, two or three transverse sections) (TM2-T(ii))

Ship's name..... Class Identity No..... Report No..... IMO number.....

SHELL PLATING																											
STRAKE POSITION	FIRST TRANSVERSE SECTION AT FRAME NUMBER....								SECOND TRANSVERSE SECTION AT FRAME NUMBER....								THIRD TRANSVERSE SECTION AT FRAME NUMBER....										
	No. or letter	Orig. thk. mm	Max allow. dimin. mm	Gauged		Diminution P		Diminution S		No. or letter	Orig. thk. mm	Max allow. dimin. mm	Gauged		Diminution P		Diminution S		No. or letter	Orig. thk. mm	Max allow. dimin. mm	Gauged		Diminution P		Diminution S	
				P	S	mm	%	mm	%				P	S	mm	%	mm	%				P	S	mm	%	mm	%
1st below sheerstrake																											
2nd																											
3rd																											
4th																											
5th																											
6th																											
7th																											
8th																											
9th																											
10th																											
11th																											
12th																											
13th																											
14th																											
15th																											
16th																											
17th																											
18th																											
19th																											
20th																											
keel strake																											
BOTTOM TOTAL																											

Operator's signature.....

Notes – see following page

Notes to report TM2-T(ii):

- 1 This report should be used for recording the thickness measurements of shell plating transverse sections:

One, two or three sections within the cargo area comprising structural items (4), (5), (6), and (7) as shown on the diagrams of typical transverse section indicating longitudinal and transverse members, in appendix 3.

- 2 The bottom area comprises keel, bottom and bilge plating.
- 3 The exact frame station of measurement should be stated.
- 4 The single measurements recorded should represent the average of multiple measurements.
- 5 The maximum allowable diminution could be stated in an attached document.

Report on thickness measurement of longitudinal members (one, two or three transverse sections) (TM3-T)

Ship's name..... Class Identity No..... Report No..... IMO number.....

STRUCTURAL MEMBER	FIRST TRANSVERSE SECTION AT FRAME NUMBER....								SECOND TRANSVERSE SECTION AT FRAME NUMBER....								THIRD TRANSVERSE SECTION AT FRAME NUMBER....											
	Item no.	Orig. thk. mm	Max allow. dimin. mm	Gauged		Diminution P		Diminution S		Item no.	Orig. thk. mm	Max allow. dimin. mm	Gauged		Diminution P		Diminution S		Item no.	Orig. thk. mm	Max allow. dimin. mm	Gauged		Diminution P		Diminution S		
				P	S	mm	%	mm	%				P	S	mm	%	mm	%				P	S	mm	%	mm	%	

Operator's signature.....

Notes – see following page

Notes to report TM3-T:

- 1 This report should be used for recording the thickness measurement of longitudinal members at transverse sections:

One, two or three sections within the cargo area comprising structural items (8) to (20) as shown on the diagrams of typical transverse section indicating longitudinal and transverse members, in appendix 3.

- 2 The exact frame station of measurement should be stated.
- 3 The single measurements recorded should represent the average of multiple measurements.
- 4 The maximum allowable diminution could be stated in an attached document.

Notes to report TM4-T:

- 1 This report should be used for recording the thickness measurement of transverse structural members, comprising appropriate structural items (25) to (32) as shown on the diagrams of typical transverse section indicating longitudinal and transverse members in appendix 3.
- 2 Guidance for areas of measurement is indicated in appendix 3.
- 3 The single measurements recorded should represent the average of multiple measurements.
- 4 The maximum allowable diminution could be stated in an attached document.

Notes to report TM5-T:

- 1 This report should be used for recording the thickness measurement of W.T./O.T. transverse bulkheads.
- 2 Guidance for areas of measurement is indicated in appendix 3.
- 3 The single measurements recorded should represent the average of multiple measurements.
- 4 The maximum allowable diminution could be stated in an attached document.

Notes to report TM6-T:

- 1 This report should be used for recording the thickness measurement of miscellaneous structural members including structural items (36), (37) and (38) shown in appendix 3.
- 2 The single measurements recorded should represent the average of multiple measurements.
- 3 The maximum allowable diminution could be stated in an attached document.

Appendix 3

GUIDANCE ON THICKNESS MEASUREMENT

Typical transverse section of oil tanker indicating longitudinal and transverse members

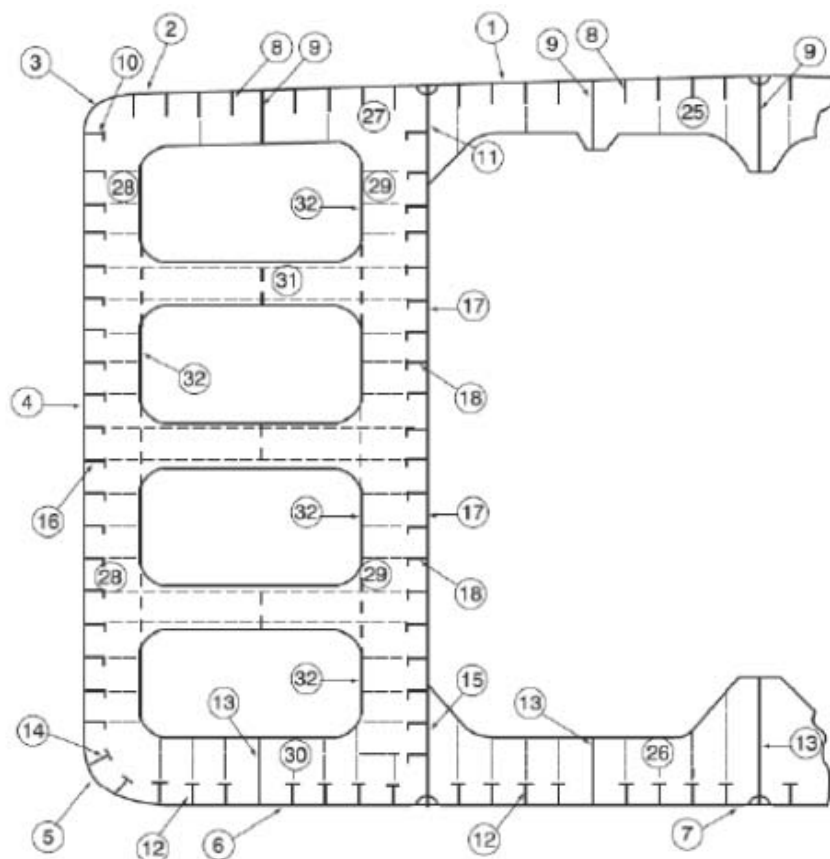

REPORT ON TM2-T(i) & (ii)	
1	Strength deck plating
2	Stringer plate
3	Sheerstrake
4	Side shell plating
5	Bilge plating
6	Bottom shell plating
7	Keel plate

REPORT ON TM6-T	
36	Hatch coamings
37	Deck plating between hatches
38	Hatch covers
39	
40	

REPORT ON TM3-T	
8	Deck longitudinals
9	Deck girders
10	Sheerstrake longitudinals
11	Longitudinal bulkhead top strake
12	Bottom longitudinals
13	Bottom girders
14	Bilge longitudinals
15	Longitudinal bulkhead lower strake
16	Side shell longitudinals
17	Longitudinal bulkhead plating (remainder)
18	Longitudinal bulkhead longitudinals
19	Inner bottom plating
20	Inner bottom longitudinals
21	
22	
23	
24	

REPORT ON TM4-T	
25	Deck transverse centre tank
26	Bottom transverse centre tank
27	Deck transverse wing tank
28	Side shell vertical web
29	Longitudinal bulkhead vertical web
30	Bottom transverse wing tank
31	Struts
32	Transverse web face plate
33	
34	D.B. floors
35	

Typical transverse section of ore/oil ship indicating longitudinal and transverse members

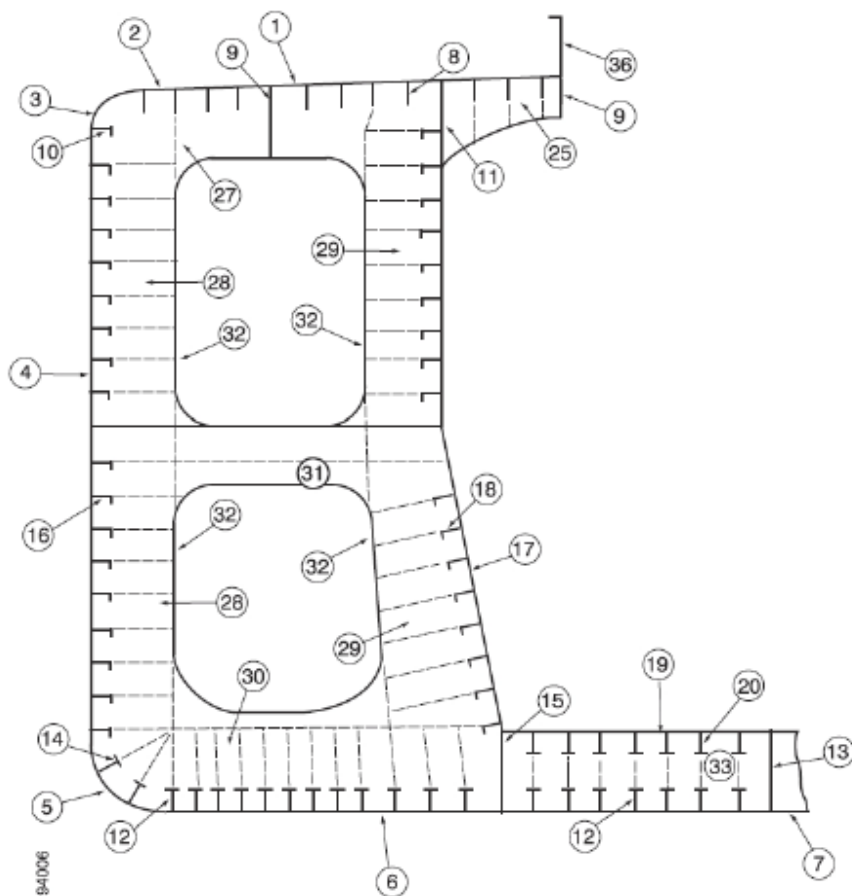

REPORT ON TM2-T(i) & (ii)	
1	Strength deck plating
2	Stringer plate
3	Sheerstrake
4	Side shell plating
5	Bilge plating
6	Bottom shell plating
7	Keel plate

REPORT ON TM6-T	
36	Hatch coamings
37	Deck plating between hatches
38	Hatch covers
39	
40	

REPORT ON TM3-T	
8	Deck longitudinals
9	Deck girders
10	Sheerstrake longitudinals
11	Longitudinal bulkhead top strake
12	Bottom longitudinals
13	Bottom girders
14	Bilge longitudinals
15	Longitudinal bulkhead lower strake
16	Side shell longitudinals
17	Longitudinal bulkhead plating (remainder)
18	Longitudinal bulkhead longitudinals
19	Inner bottom plating
20	Inner bottom longitudinals
21	
22	
23	
24	

REPORT ON TM4-T	
25	Deck transverse centre tank
26	Bottom transverse centre tank
27	Deck transverse wing tank
28	Side shell vertical web
29	Longitudinal bulkhead vertical web
30	Bottom transverse wing tank
31	Struts
32	Transverse web face plate
33	D.B. floors
34	
35	

Transverse section outline (to be used for longitudinal and transverse members where typical oil tanker or oil/ore ship sections are not applicable)

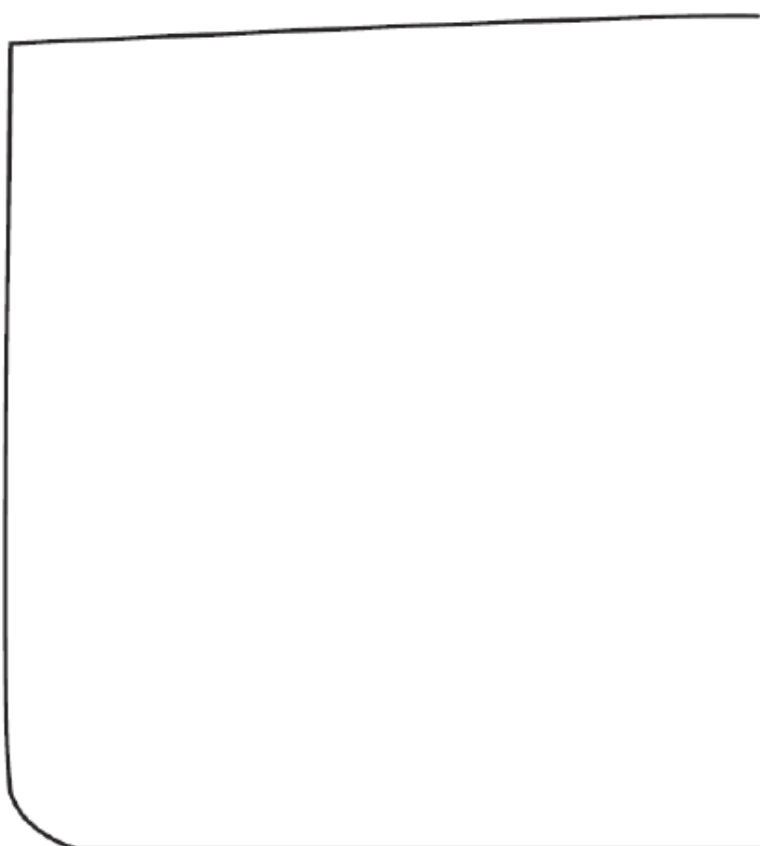

REPORT ON TM2-T  & 	
①	Strength deck plating
②	Stringer plate
③	Sheerstrake
④	Side shell plating
⑤	Bilge plating
⑥	Bottom shell plating
⑦	Keel plate

REPORT ON TM6-T	
③⑥	Hatch coamings
③⑦	Deck plating between hatches
③⑧	Hatch covers
③⑨	
④①	

REPORT ON TM3-T	
⑧	Deck longitudinals
⑨	Deck girders
⑩	Sheerstrake longitudinals
⑪	Longitudinal bulkhead top strake
⑫	Bottom longitudinals
⑬	Bottom girders
⑭	Bilge longitudinals
⑮	Longitudinal bulkhead lower strake
⑯	Side shell longitudinals
⑰	Longitudinal bulkhead plating (remainder)
⑱	Longitudinal bulkhead longitudinals
⑲	Inner bottom plating
⑳	Inner bottom longitudinals
㉑	
㉒	
㉓	
㉔	

REPORT ON TM4-T	
㉕	Deck transverse centre tank
㉖	Bottom transverse centre tank
㉗	Deck transverse wing tank
㉘	Side shell vertical web
㉙	Longitudinal bulkhead vertical web
㉚	Bottom transverse wing tank
㉛	Struts
㉜	Transverse web face plate
㉝	D.B. floors
㉞	
㉟	

**Typical transverse sections showing all longitudinal members
to be reported on TM2-T(i) & (ii) and TM3-T**

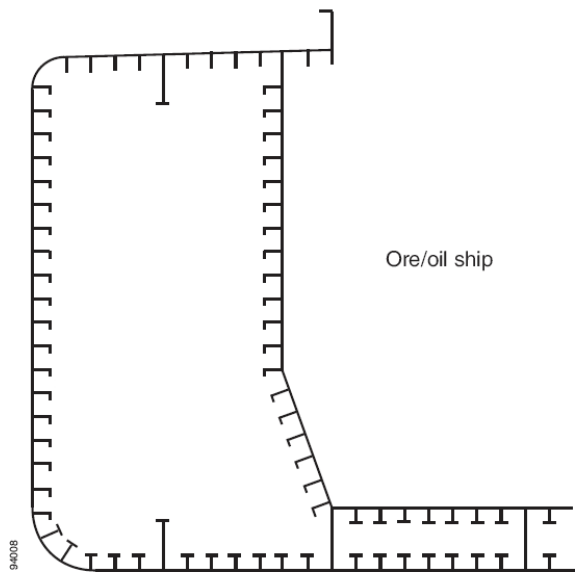
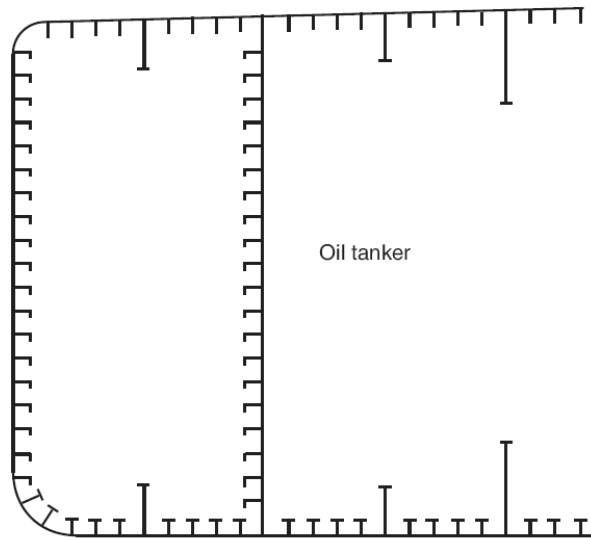

Close-up survey requirements

(Transverse sections of oil tankers and ore/oil ships showing typical areas for thickness measurement in association with close-up survey requirements)

Oil tanker:
typical transverse section

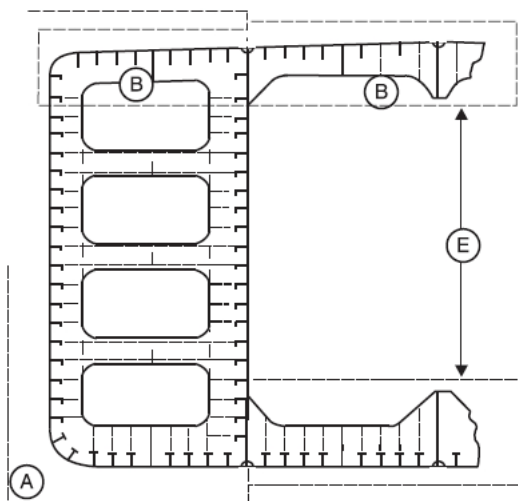

Thickness to be reported on
TM3-T and TM4-T as appropriate

Oil tanker:
typical transverse bulkhead

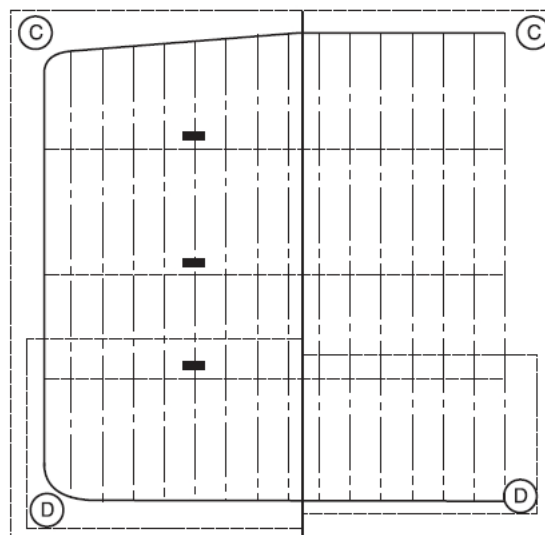

Thickness to be reported on TM5-T

Ore/oil ship:
typical transverse section

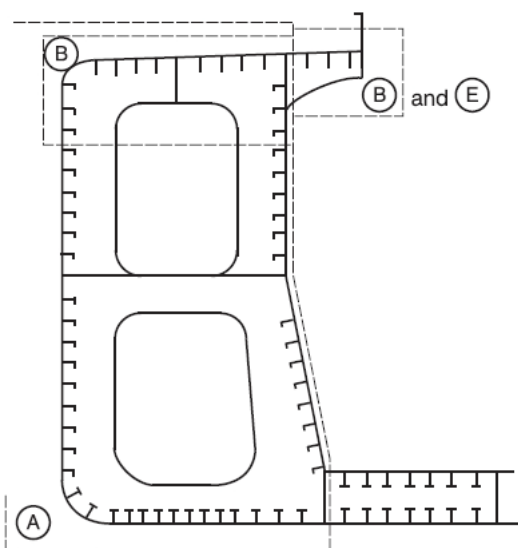

Thickness to be reported on
TM3-T and TM4-T as appropriate

Ore/oil ship:
typical transverse bulkhead

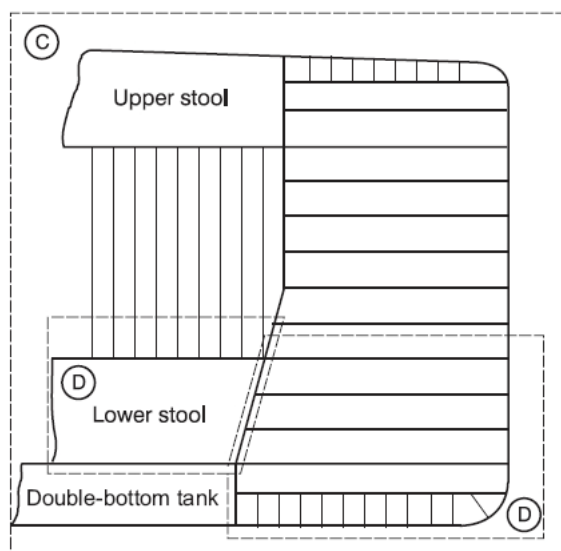

Thickness to be reported on TM5-T

94009

Close-up
survey area

Recommendations for the extent and pattern of thickness
measurements are indicated in annex 4.

ANNEX 11

**GUIDELINES FOR TECHNICAL ASSESSMENT IN CONJUNCTION WITH
THE PLANNING OF ENHANCED SURVEYS FOR OIL TANKERS****Renewal survey****1 Introduction**

These Guidelines contain information and suggestions concerning technical assessments which may be of use in conjunction with the planning of enhanced special surveys of oil tankers. As indicated in 5.1.5, these Guidelines are a recommended tool which may be invoked at the discretion of an Administration, when considered necessary and appropriate, in conjunction with the preparation of the required survey programme.

2 Purpose and principles**2.1 Purpose**

The purpose of the technical assessments described in these Guidelines is to assist in identifying critical structural areas, nominating suspect areas and in focusing attention on structural elements or areas of structural elements which may be particularly susceptible to, or evidence a history of, wastage or damage. This information may be useful in nominating locations, areas and tanks for thickness measurement, close-up survey and tank testing.

2.2 Minimum requirements

These Guidelines may not be used to reduce the requirements of annexes 1, 2 and 3 for close-up survey, thickness measurement and tank testing, respectively, which are, in all cases, to be complied with as a minimum.

2.3 Timing

As with other aspects of survey planning, the technical assessments described in these Guidelines should be carried out by the owner or operator in cooperation with the Administration well in advance of the commencement of the renewal survey, i.e. prior to commencing the survey and normally at least 12 to 15 months before the survey's completion due date.

2.4 Aspects to be considered

2.4.1 Technical assessments, which may include quantitative or qualitative evaluation of relative risks of possible deterioration, of the following aspects of a particular ship may be used as a basis for the nomination of tanks and areas for survey:

- .1 design features such as stress levels on various structural elements, design details and extent of use of high-tensile steel (HTS);
- .2 former history with respect to corrosion, cracking, buckling, indents and repairs for the particular ship as well as similar vessels, where available; and
- .3 information with respect to types of cargo carried, use of different tanks for cargo/ballast, protection of tanks and condition of coating, if any.

2.4.2 Technical assessments of the relative risks of susceptibility to damage or deterioration of various structural elements and areas should be judged and decided on the basis of recognized principles and practices, such as may be found in references 1 and 2.

3 Technical assessment

3.1 General

3.1.1 There are three basic types of possible failure which may be the subject of technical assessment in connection with planning of surveys: corrosion, cracks and buckling. Contact damages are not normally covered by the survey plan since indents are usually noted in memoranda and assumed to be dealt with as a normal routine by surveyors.

3.1.2 Technical assessments performed in conjunction with the survey planning process should, in principle, be as shown schematically in figure 1 which depicts, schematically, how technical assessments can be carried out in conjunction with the survey planning process. The approach is basically an evaluation of the risk based on the knowledge and experience related to design and corrosion.

3.1.3 The design should be considered with respect to structural details which may be susceptible to buckling or cracking as a result of vibration, high stress levels or fatigue.

3.1.4 Corrosion is related to the ageing process, and is closely connected with the quality of corrosion protection at newbuilding, and subsequent maintenance during the service life. Corrosion may also lead to cracking and/or buckling.

3.2 Methods

3.2.1 Design details

3.2.1.1 Damage experience related to the ship in question and similar ships, where available, are the main source of information to be used in the process of planning. In addition, a selection of structural details from the design drawings should be included. Typical damage experience to be considered will consist of:

- .1 number, extent, location and frequency of cracks; and
- .2 location of buckles.

3.2.1.2 This information may be found in the survey reports and/or the owner's files, including the results of the owner's own inspections. The defects should be analysed, noted and marked on sketches.

3.2.1.3 In addition, general experience should be utilized. For example, reference should be made to reference 1, which contains a catalogue of typical damages and proposed repair methods for various tanker structural details.

3.2.1.4 Such figures should be used together with a review of the main drawings, in order to compare with the actual structure and search for similar details which may be susceptible to damage. An example is shown in figure 2.

3.2.1.5 The review of the main structural drawings, in addition to using the above-mentioned figures, should include checking for typical design details where cracking has been experienced. The factors contributing to damage should be carefully considered.

3.2.1.6 The use of HTS is an important factor. Details showing good service experience where ordinary, mild steel has been used may be more susceptible to damage when HTS, and its higher associated stresses, are utilized. There is extensive and, in general, good experience, with the use of HTS for longitudinal material in deck and bottom structures. Experience in other locations, where the dynamic stresses may be higher, is less favourable, e.g. side structures.

3.2.1.7 In this respect, stress calculations of typical and important components and details, in accordance with relevant methods, may prove useful and should be considered.

3.2.1.8 The selected areas of the structure identified during this process should be recorded and marked on the structural drawings to be included in the survey programme.

3.2.2 *Corrosion*

3.2.2.1 In order to evaluate relative corrosion risks, the following information is generally to be considered:

- .1 usage of tanks and spaces;
- .2 condition of coatings;
- .3 condition of anodes;
- .4 cleaning procedures;
- .5 previous corrosion damage;
- .6 ballast use and time for cargo tanks;
- .7 corrosion risk scheme (see reference 2, table 3.1); and
- .8 location of heated tanks.

3.2.2.2 Reference 2 gives definitive examples which can be used for judging and describing coating condition, using typical pictures of conditions.

3.2.2.3 The evaluation of corrosion risks should be based on information in reference 2, together with the age of the ship and relevant information on the anticipated condition as derived from the information collected in order to prepare the survey programme.

3.2.2.4 The various tanks and spaces should be listed with the corrosion risks nominated accordingly.

3.2.3 *Locations for close-up survey and thickness measurement*

3.2.3.1 On the basis of the table of corrosion risks and the evaluation of design experience, the locations for initial close-up survey and thickness measurement (sections) may be nominated.

3.2.3.2 The sections subject to thickness measurement should normally be nominated in tanks and spaces where corrosion risk is judged to be the highest.

3.2.3.3 The nomination of tanks and spaces for close-up survey should, initially, be based on highest corrosion risk, and should always include ballast tanks. The principle for the selection should be that the extent is increased by age or where information is insufficient or unreliable.

References

- 1 TSCF, Guidance Manual for the Inspection and Condition Assessment of Tanker Structures, 1986.
- 2 TSCF, Condition Evaluation and Maintenance of Tanker Structures, 1992.

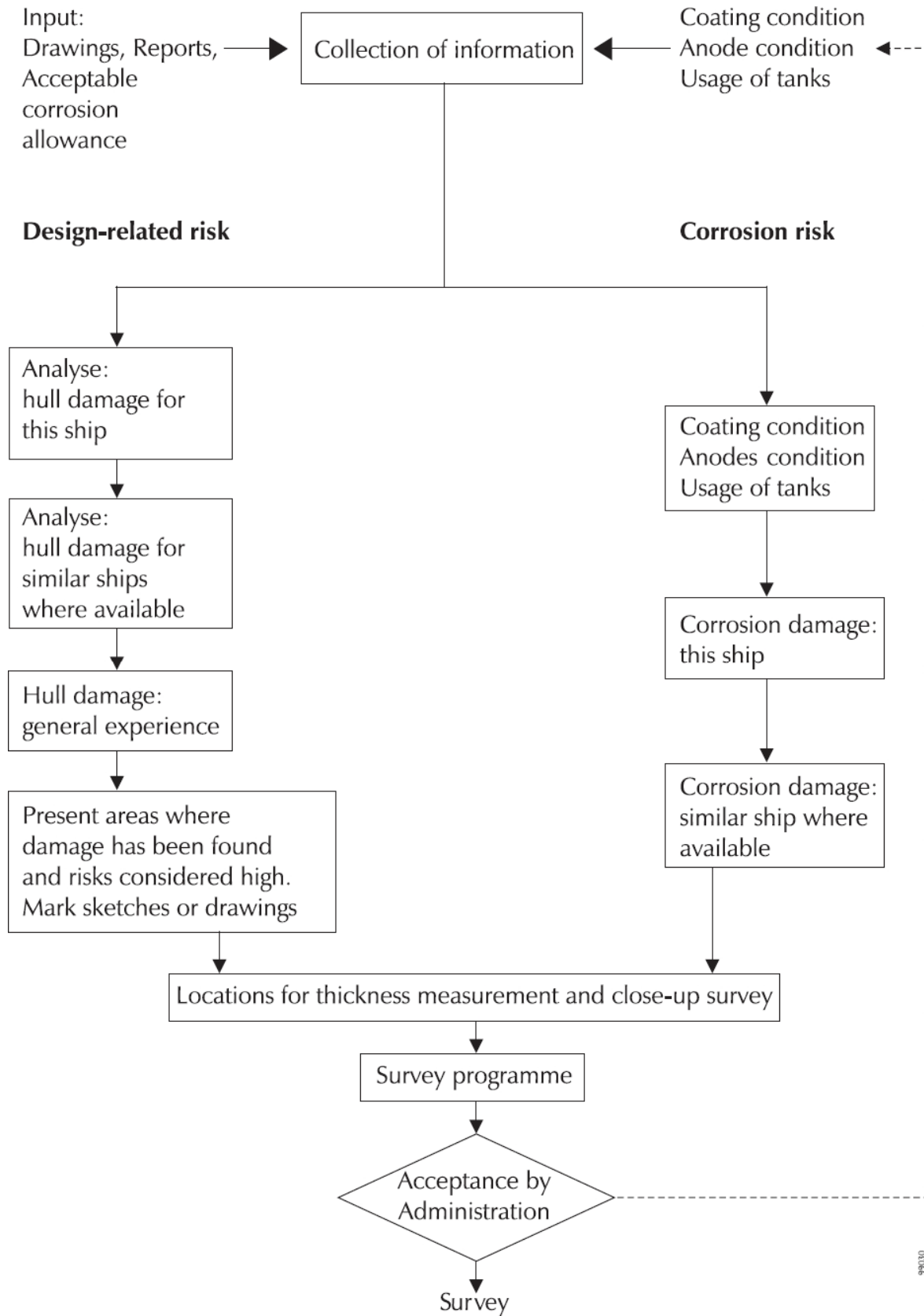

Figure 1 – Planning process: technical assessment and the survey

LOCATION: Connection of longitudinals to transverse webs		
EXAMPLE NO. 1 Web and flat bar fractures at cut-outs for longitudinal stiffener connections		
TYPICAL DAMAGE	PROPOSED REPAIR	
  <p style="text-align: center;">view A-A</p> <p><i>Note* one or more fractures may occur</i></p>	<p style="text-align: right;">full collar if fractures in web plate are small and are repaired by welding</p>   <p style="text-align: center;">view A-A</p> <p><i>web and flat bar cropped and part renewed or alternatively welded</i></p>	
<p>FACTORS CONTRIBUTING TO DAMAGE</p> <ol style="list-style-type: none"> 1 Asymmetrical connection of flat bar stiffener resulting in high peak stresses at the heel of the stiffener under fatigue loading. 2 Insufficient area of connection of longitudinal to web plate. 3 Defective weld at return around the plate thickness. 4 High localized corrosion at areas of stress concentration such as flat bar stiffener connections, corners of cut-out for the longitudinal and connection of web to shell at cut-outs. 5 High shear stress in the web of the transverse. 6 Dynamic seaway loads/ship motions. 		
FIGURE 1	TANKER STRUCTURE CO-OPERATIVE FORUM SUBJECT: CATALOGUE OF STRUCTURAL DETAILS	FIGURE 1

Figure 2 – Typical damage and repair example (reproduced from reference 1)

ANNEX 12

**CRITERIA FOR LONGITUDINAL STRENGTH OF HULL GIRDER
FOR OIL TANKERS****1 General**

1.1 These criteria should be used for the evaluation of the longitudinal strength of the ship's hull girder as required by 8.1.2.

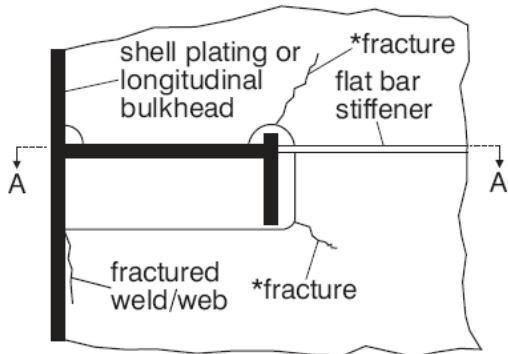
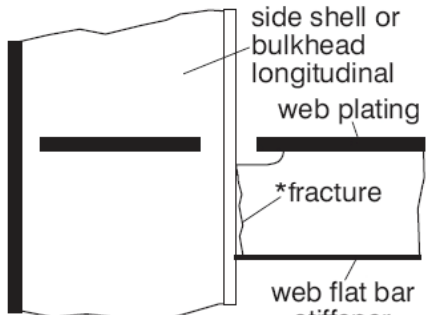
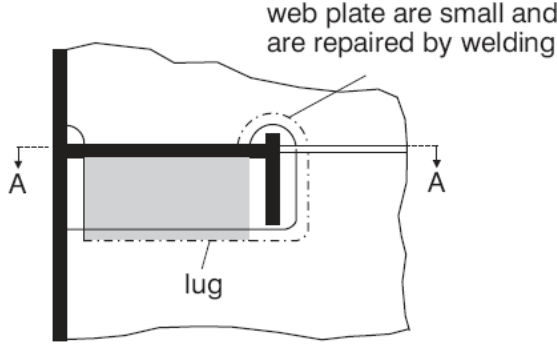
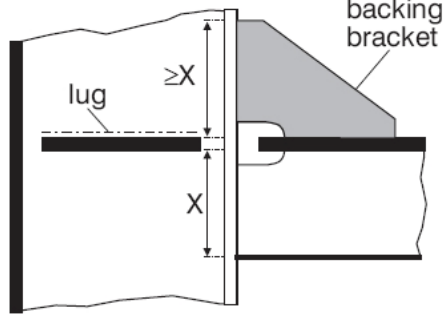
1.2 In order that the ship's longitudinal strength to be evaluated can be recognized as valid, fillet welding between longitudinal internal members and hull envelopes should be in sound condition so as to keep the integrity of longitudinal internal members with hull envelopes.

2 Evaluation of longitudinal strength

On oil tankers of 130 m in length and upwards and over 10 years of age, the longitudinal strength of the ship's hull girder should be evaluated in compliance with the requirements of this annex on the basis of the thickness measured, renewed or reinforced, as appropriate, during the renewal survey of the Cargo Ship Safety Construction Certificate or Cargo Ship Safety Certificate (SC renewal survey). The condition of the hull girder for longitudinal strength evaluation should be determined in accordance with the methods specified in appendix 3.

2.1 Calculation of transverse sectional areas of deck and bottom flanges of hull girder

2.1.1 The transverse sectional areas of deck flange (deck plating and deck longitudinals) and bottom flange (bottom shell plating and bottom longitudinals) of the ship's hull girder should be calculated by using the thickness measured, renewed or reinforced, as appropriate, during the SC renewal survey.

2.1.2 If the diminution of sectional areas of either deck or bottom flange exceeds 10 per cent of their respective as-built area (i.e. original sectional area when the ship was built), either one of the following measures should be taken:

- .1 to renew or reinforce the deck or bottom flanges so that the actual sectional area is not less than 90 per cent of the as-built area; or
- .2 to calculate the actual section of moduli (Z_{act}) of transverse section of the ship's hull girder by applying the calculation method specified in appendix 1, by using the thickness measured, renewed or reinforced, as appropriate, during the SC renewal survey.

2.2 Requirements for transverse section modulus of hull girder

2.2.1 The actual section moduli of the transverse section of the ship's hull girder, calculated in accordance with paragraph 2.1.2.2, should satisfy either of the following provisions, as applicable:

- .1 for ships constructed on or after 1 July 2002, the actual section moduli (Z_{act}) of the transverse section of the ship's hull girder calculated in accordance with the requirements of paragraph 2.1.2.2 should be not less than the diminution limits determined by the Administration, taking into account the recommendations adopted by the Organization;²² or
- .2 for ships constructed before 1 July 2002, the actual section moduli (Z_{act}) of the transverse section of the ship's hull girder calculated in accordance with the requirements of paragraph 2.1.2.2 should meet the criteria for minimum section modulus for ships in service required by the Administration or recognized classification society, provided that in no case Z_{act} should be less than the diminution limit of the minimum section modulus (Z_{mc}) as specified in appendix 2.

²² Refer to resolution MSC.108(73), Recommendation on compliance with the requirements of paragraph 2.2.1.1 of annex 12 to annex B to resolution A.744(18).

Appendix 1**CALCULATION CRITERIA OF SECTION MODULI OF
MIDSHIP SECTION OF HULL GIRDER**

1 When calculating the transverse section modulus of the ship's hull girder, the sectional area of all continuous longitudinal strength members should be taken into account.

2 Large openings, i.e. openings exceeding 2.5 m in length or 1.2 m in breadth, and scallops, where scallop welding is applied, are always to be deducted from the sectional areas used in the section modulus calculation.

3 Smaller openings (manholes, lightening holes, single scallops in way of seams, etc.) need not be deducted, provided that the sum of their breadths or shadow area breadths in one transverse section does not reduce the section modulus at deck or bottom by more than 3 per cent and provided that the height of lightening holes, draining holes and single scallops in longitudinals or longitudinal girders does not exceed 25 per cent of the web depth, for scallops of maximum 75 mm.

4 A deduction-free sum of smaller opening breadths in one transverse section in the bottom or deck area of $0.06 (B - \Sigma b)$ (where B = breadth of ship, Σb = total breadth of large openings) may be considered equivalent to the above reduction in sectional modulus.

5 The shadow area will be obtained by drawing two tangent lines with an opening angle of 30° .

6 The deck modulus is related to the moulded deck line at side.

7 The bottom modulus is related to the base line.

8 Continuous trunks and longitudinal hatch coamings should be included in the longitudinal sectional area provided they are effectively supported by longitudinal bulkheads or deep girders. The deck modulus is then to be calculated by dividing the moment of inertia by the following distance, provided this is greater than the distance to the deck line at side:

$$y_t = y \left(0.9 + 0.2 \frac{x}{B} \right)$$

where:

y = distance from neutral axis to top of continuous strength member;

x = distance from top of continuous strength member to centerline of the ship;

x and y to be measured to the point giving the largest value of y_t .

9 Longitudinal girders between multi-hatchways will be considered by special calculations.

Appendix 2

DIMINUTION LIMIT OF MINIMUM LONGITUDINAL STRENGTH OF SHIPS IN SERVICE

1 The diminution limit of the minimum section modulus (Z_{mc}) of oil tankers in service is given by the following formula:

$$Z_{mc} = cL^2 B (C_b + 0.7)k \quad (\text{cm}^3)$$

where:

L = Length of ship. L is the distance, in metres, on the summer load waterline from the fore-side of stem to the after-side of the rudder post, or the centre of the rudder stock if there is no rudder post. L is not to be less than 96 per cent, and need not be greater than 97 per cent, of the extreme length on the summer load waterline. In ships with unusual stern and bow arrangement, the length L may be specially considered.

B = Greatest moulded breadth in metres.

C_b = Moulded block coefficient at draught d corresponding to summer load waterline, based on L and B . C_b is not to be taken less than 0.6.

$$C_b = \frac{\text{moulded displacement (m}^3\text{) at draught } d}{LBd}$$

$$c = 0.9c_n$$

$$c_n = 10.75 - \left(\frac{300-L}{100}\right)^{1.5} \quad \text{for } 130 \text{ m} \leq L \leq 300 \text{ m}$$

$$c_n = 10.75 \quad \text{for } 300 \text{ m} \leq L \leq 350 \text{ m}$$

$$c_n = 10.75 - \left(\frac{L-350}{150}\right)^{1.5} \quad \text{for } 350 \text{ m} \leq L \leq 500 \text{ m}$$

k = material factor, e.g.

$$k = 1.0 \text{ for mild steel with yield stress of } 235 \text{ N/mm}^2 \text{ and over}$$

$$k = 0.78 \text{ for high-tensile steel with yield stress of } 315 \text{ N/mm}^2 \text{ and over}$$

$$k = 0.72 \text{ for high-tensile steel with yield stress of } 355 \text{ N/mm}^2 \text{ and over.}$$

2 Scantlings of all continuous longitudinal members of the ship's hull girder based on the section modulus requirement in 1 above should be maintained within $0.4L$ amidships. However, in special cases, based on consideration of type of ship, hull form and loading conditions, the scantlings may be gradually reduced towards the end of $0.4L$ part, bearing in mind the desire not to inhibit the ship's loading flexibility.

3 However, the above standard may not be applicable to ships of unusual type or design, e.g. for ships of unusual main proportions and/or weight distributions.

Appendix 3

SAMPLING METHOD OF THICKNESS MEASUREMENTS FOR LONGITUDINAL STRENGTH EVALUATION AND REPAIR METHODS

1 Extent of longitudinal strength evaluation

Longitudinal strength should be evaluated within $0.4L$ amidships for the extent of the hull girder length that contains tanks therein and within $0.5L$ amidships for adjacent tanks which may extend beyond $0.4L$ amidships, where tanks means ballast tanks and cargo tanks.

2 Sampling method of thickness measurement

2.1 Pursuant to the requirements of section 2.5, transverse sections should be chosen such that thickness measurements can be taken for as many different tanks in corrosive environments as possible, e.g. ballast tanks sharing a common plane boundary with cargo tanks fitted with heating coils, other ballast tanks, cargo tanks permitted to be filled with sea water and other cargo tanks. Ballast tanks sharing a common plane boundary with cargo tanks fitted with heating coils and cargo tanks permitted to be filled with seawater should be selected where present.

2.2 The minimum number of transverse sections to be sampled should be in accordance with annex 2. The transverse sections should be located where the largest thickness reductions are suspected to occur or are revealed from deck and bottom plating measurements prescribed in 2.3 and should be clear of areas which have been locally renewed or reinforced.

2.3 At least two points should be measured on each deck plate and/or bottom shell plate required to be measured within the cargo area in accordance with the requirements of annex 2.

2.4 Within $0.1D$ (where D is the ship's moulded depth) of the deck and bottom at each transverse section to be measured in accordance with the requirements of annex 2, every longitudinal and girder should be measured on the web and face plate, and every plate should be measured at one point between longitudinals.

2.5 For longitudinal members other than those specified in 2.4 to be measured at each transverse section in accordance with the requirements of annex 2, every longitudinal and girder should be measured on the web and face plate, and every plate should be measured at least in one point per strake.

2.6 The thickness of each component should be determined by averaging all of the measurements taken in way of the transverse section on each component.

3 Additional measurements where the longitudinal strength is deficient

3.1 Where one or more of the transverse sections are found to be deficient in respect of the longitudinal strength requirements given in this annex, the number of transverse sections for thickness measurement should be increased such that each tank within the $0.5L$ amidships region has been sampled. Tank spaces that are partially within, but extend beyond, the $0.5L$ region, should be sampled.

3.2 Additional thickness measurements should also be performed on one transverse section forward and one aft of each repaired area to the extent necessary to ensure that the areas bordering the repaired section also comply with the requirements of the Code.

4 Effective repair methods

4.1 The extent of renewal or reinforcement carried out to comply with this annex should be in accordance with 4.2.

4.2 The minimum continuous length of a renewed or reinforced structural member should be not less than twice the spacing of the primary members in way. In addition, the thickness diminution in way of the butt joint of each joining member forward and aft of the replaced member (plates, stiffeners, girder webs and flanges, etc.) should not be within the substantial corrosion range (75% of the allowable diminution associated with each particular member). Where differences in thickness at the butt joint exceed 15 per cent of the lower thickness, a transition taper should be provided.

4.3 Alternative repair methods involving the fitting of straps or structural member modification should be subject to special consideration. In considering the fitting of straps, it should be limited to the following conditions:

- .1 to restore and/or increase longitudinal strength;
- .2 the thickness diminution of the deck or bottom plating to be reinforced should not be within the substantial corrosion range (75% of the allowable diminution associated with the deck plating);
- .3 the alignment and arrangement, including the termination of the straps, is in accordance with a standard recognized by the Administration;
- .4 the straps are continuous over the entire $0.5L$ amidships length; and
- .5 continuous fillet welding and full penetration welds are used at butt welding and, depending on the width of the strap, slot welds. The welding procedures applied should be acceptable to the Administration.

4.4 The existing structure adjacent to replacement areas and in conjunction with the fitted straps, etc., should be capable of withstanding the applied loads, taking into account the buckling resistance and the condition of welds between the longitudinal members and hull envelope plating.
